



Eine einzigartige Kollektion mit zwölf brandneuen Farben in einer breiten Palette von Formaten für Wand- und Bodenfliesen. Das neutrale und einheitliche Design aus weichem Granit bietet unendliche Möglichkeiten innerhalb der COMPILA-Serie und in Kombination mit anderen RAKO-Serien, um jeden öffentlichen oder privaten Raum zu gestalten.

Es kann so originell sein wie Sie selbst!

„Perfekte Kompilation von Formaten, Farben und Dekorationen.“



A unique collection of twelve brand new colors in wide range of formats in both wall and floor tiles. Neutral and uniform soft granite design offers never-ending possibilities within COMPILA series, or by combining with other RAKO series, to transform any public or residential space.

It can be as original as you are!

„The ultimate compilation of colors, formats and decorations.“



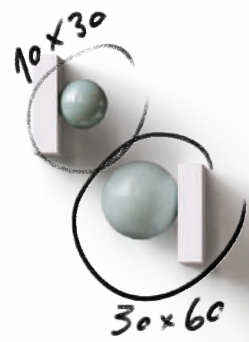

mint



botanic



aqua



nude



taupe



cement



paper



shadow



storm



cotto



coal



sand

Handwritten notes:
Compilation 001
Floor:
 - COMPILA COTTO 60x60
 - PLYWOOD HONEY 60x120
WALL:
 - COMPILA PAPER 30x60
 - COMPILA MINT 30x60
 - COMPILA MINT 10x30

The art of compilations

Compila für Ihre Inspiration...

Jede Fliese der Compila ist so konzipiert, dass es sowohl ästhetischen als auch technischen Ansprüchen entspricht.

Die einzelnen Ambiente auf den folgenden Seiten zeigen, wie einfach es ist, verschiedene Fliesen der Compila-Serie miteinander und mit anderen Produkten aus dem RAKO-Sortiment zu kombinieren. Die Serie Compila zeichnet sich durch ihre Vielseitigkeit, Originalität und Fantasie aus, die sich in der Auswahl an Farben, Formaten und Oberflächen widerspiegelt.

In den einzelnen Abbildungen werden die Fliesen mit verschiedenen Oberfläche von glänzend bis matt präsentiert. Zum besseren Verständnis werden diese Unterschiede mit Kugelmodellen dargestellt. Für das vertikal ausgerichtete Regal werden Elemente für die Wand, während die horizontal Darstellung die Bodenfliesen präsentiert.



Compilation for Your Inspiration...

The Compila series is designed to meet both aesthetics and technical requirements.

The following pages showcase individual product compositions, illustrating the possible combinations of different elements from the Compila series as well as other products within the RAKO range.

Defined by its versatility, originality and creativity, the series presents a diverse range of colors, formats, and surfaces. From high gloss to full matt, each product is presented with a specific surface type, clarified through sphere models for better visualization.

The vertically oriented shelf displays elements designed for walls, while the horizontally positioned partitions represent floor tile products. These visualizations provide a clear understanding of the final look that can be achieved once the selected products are installed in a space.



Handwritten note:
 COMPILA MINT 10x30

10x30
compila
mini



30x90
blossom
rich



20x60
majolika
white



30x60
compila
cement



60x60
compila
ornamento

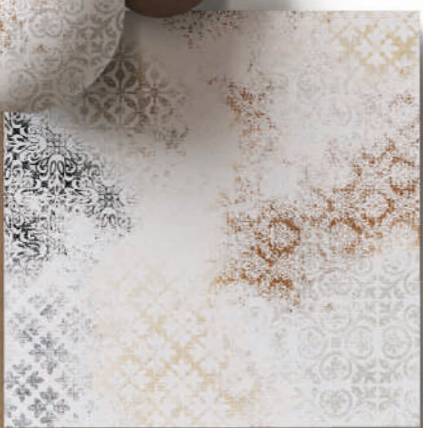

60x120
craft
pottery



10x30
compila
aqua



10x30
compila
storm



30x60
compila
herbs



30x60
compila
aqua



30x60
compila
paper



60x60
compila
storm



60x120
fly
mist



20x120
pino
bloom





Produkt product								
EN 14411 - G Bla STO Nr. 030 - 059824	Bodenfliese floor tile	Bodenfliese floor tile	Bodenfliese floor tile	Bodenfliese floor tile	Bodenfliese floor tile	Bodenfliese floor tile	Bodenfliese floor tile	Bodenfliese floor tile
	120×120 R News	60×120 R	60×60 R	30×60 R	45×45	30×30		
	1198×1198×8,5	598×1198×10* 598×1198×9**	598×598×9	298×598×9	448×448×8	298×298×8		
Oberfläche surface	ABS	ABS	ABS	matt	ABS	matt	ABS	ABS
Rutschfestigkeit slip resistance	R10/B	R10/B	R10/B	R11/B	R10/B	R11/B	R10/B	R10/B
Reibungskoeffizient - trocken sliding friction coefficient - dry	μ ≥ 0,6	μ ≥ 0,6	μ ≥ 0,6	μ ≥ 0,6	μ ≥ 0,6	μ ≥ 0,6	μ ≥ 0,6	μ ≥ 0,6
Farbe color								
Shadow dunkelgrau dark grey	DAK92866 ○ 900 m ²	DAKV1866* DAKV9866** ○ 700 m ²	DAK62866 ○ 560 m ²	DAF62866 ○ 640 m ²	DAKSR866 ○ 540 m ²	DAFSR866 ○ 620 m ²	DAA4H866 ○ 510 m ²	DAA34866 ○ 390 m ²
Taupe grau-beige grey-beige	DAK92867 ○ 900 m ²	DAKV1867* DAKV9867** ○ 700 m ²	DAK62867 ○ 560 m ²	DAF62867 ○ 640 m ²	DAKSR867 ○ 540 m ²	DAFSR867 ○ 620 m ²	DAA4H867 ○ 510 m ²	DAA34867 ○ 390 m ²
Paper weiß-grau white-grey	DAK92864 ○ 900 m ²	DAKV1864* DAKV9864** ○ 700 m ²	DAK62864 ○ 560 m ²	DAKSR864 ○ 540 m ²			DAA4H864 ○ 510 m ²	DAA34864 ○ 390 m ²
Cement grau grey	DAK92865 ○ 900 m ²	DAKV1865* DAKV9865** ○ 700 m ²	DAK62865 ○ 560 m ²	DAF62865 ○ 640 m ²	DAKSR865 ○ 540 m ²	DAFSR865 ○ 620 m ²	DAA4H865 ○ 510 m ²	DAA34865 ○ 390 m ²
Storm schwarz-blau black-blue		DAKV1870* DAKV9870** ○ 700 m ²	DAK62870 ○ 560 m ²		DAKSR870 ○ 540 m ²		DAA4H870 ○ 510 m ²	DAA34870 ○ 390 m ²
Cotto braun-rot brown-red		DAKV1869* DAKV9869** ○ 700 m ²	DAK62869 ○ 560 m ²		DAKSR869 ○ 540 m ²		DAA4H869 ○ 510 m ²	DAA34869 ○ 390 m ²
Sand ocker ochre		DAKV1868* DAKV9868** ○ 700 m ²	DAK62868 ○ 560 m ²		DAKSR868 ○ 540 m ²		DAA4H868 ○ 510 m ²	DAA34868 ○ 390 m ²
Coal braun-schwarz brown-black		DAKV1871* DAKV9871** ○ 700 m ²	DAK62871 ○ 560 m ²		DAKSR871 ○ 540 m ²		DAA4H871 ○ 510 m ²	DAA34871 ○ 390 m ²
logistische Daten logistic information								
	2	2 2	4	7	6	13		
	0,7	1,4 1,4	2,8	5,6	5	11		
	2,88	1,44 1,44	1,44	1,26	1,21	1,18		
	24	27 30	32	40	34	48		
	69,12	38,88 43,20	46,08	50,40	41,14	56,64		
	53,1	32,7 30,0	27,6	24,2	21,1	20,5		
	18,9	22,7 20,9	19,2	19,2	17,4	17,4		
	1 330	908 924	910	993	741	1 011		

* Verfügbar solange der Vorrat reicht | Available while stocks last

** Neues Produkt in 9 mm Stärke im Laufe des Jahres 2025 verfügbar | New product in 9 mm thickness available during 2025

Bodenfliese floor tile	Mosaik sheet 30×30 cm mosaic sheet 30×30cm	Stufe step tile	Stufe step tile	Stufenformteil special step tile	Socket skirting plinth	Socket skirting plinth	Socket skirting plinth	Socket skirting plinth	Hohlkeh- socket cove skirting
10×10 R	5×5 R	30×120 R	30×60 R	30×120 R	120×7,2 R News	60×7,2 R	45×8,5	30×7,2	30×11 News
98×98×9	48×48×9	298×1198×10* 298×1198×9**	298×598×9	298×1198×10* 298×1198×9**	1198×72×9	598×72×9	448×85×8	298×72×8	298×110×8
ABS	ABS	ABS	ABS	ABS	ABS	ABS	ABS	ABS	ABS
R10/B	R10/B	R10/B	R10/B	R10/B					
μ ≥ 0,6	μ ≥ 0,6	μ ≥ 0,6	μ ≥ 0,6	μ ≥ 0,6					
DAK11866 ○ 900 m ²	DDM05866 ○ 300 Netz	DCPVF866* DCPVD866** ○ 740 St	DCPSR866 ○ 270 St	DCFVF866* DCFVD866** ○ 1300 St	DSA99866 ○ 380 St	DSAS3866 ○ 180 St	DSAPS866 ○ 160 St	DSAJ8866 ○ 110 St	DSPJT866 ○ 200 St
DAK11867 ○ 900 m ²	DDM05867 ○ 300 Netz	DCPVF867* DCPVD867** ○ 740 St	DCPSR867 ○ 270 St	DCFVF867* DCFVD867** ○ 1300 St	DSA99867 ○ 380 St	DSAS3867 ○ 180 St	DSAPS867 ○ 160 St	DSAJ8867 ○ 110 St	DSPJT867 ○ 200 St
DAK11864 ○ 900 m ²	DDM05864 ○ 300 Netz	DCPVF864* DCPVD864** ○ 740 St	DCPSR864 ○ 270 St	DCFVF864* DCFVD864** ○ 1300 St	DSA99864 ○ 380 St	DSAS3864 ○ 180 St	DSAPS864 ○ 160 St	DSAJ8864 ○ 110 St	DSPJT864 ○ 200 St
DAK11865 ○ 900 m ²	DDM05865 ○ 300 Netz	DCPVF865* DCPVD865** ○ 740 St	DCPSR865 ○ 270 St	DCFVF865* DCFVD865** ○ 1300 St	DSA99865 ○ 380 St	DSAS3865 ○ 180 St	DSAPS865 ○ 160 St	DSAJ8865 ○ 110 St	DSPJT865 ○ 200 St
DAK11870 ○ 900 m ²	DDM05870 ○ 300 Netz	DCPVF870* DCPVD870** ○ 740 St	DCPSR870 ○ 270 St	DCFVF870* DCFVD870** ○ 1300 St		DSAS3870 ○ 180 St	DSAPS870 ○ 160 St	DSAJ8870 ○ 110 St	DSPJT870 ○ 200 St
DAK11869 ○ 900 m ²	DDM05869 ○ 300 Netz	DCPVF869* DCPVD869** ○ 740 St	DCPSR869 ○ 270 St	DCFVF869* DCFVD869** ○ 1300 St		DSAS3869 ○ 180 St	DSAPS869 ○ 160 St	DSAJ8869 ○ 110 St	DSPJT869 ○ 200 St
DAK11868 ○ 900 m ²	DDM05868 ○ 300 Netz	DCPVF868* DCPVD868** ○ 740 St	DCPSR868 ○ 270 St	DCFVF868* DCFVD868** ○ 1300 St		DSAS3868 ○ 180 St	DSAPS868 ○ 160 St	DSAJ8868 ○ 110 St	DSPJT868 ○ 200 St
DAK11871 ○ 900 m ²	DDM05871 ○ 300 Netz	DCPVF871* DCPVD871** ○ 740 St	DCPSR871 ○ 270 St	DCFVF871* DCFVD871** ○ 1300 St		DSAS3871 ○ 180 St	DSAPS871 ○ 160 St	DSAJ8871 ○ 110 St	DSPJT871 ○ 200 St
11	3	3 3	5	2 2	11	14	25	30	35
11	11	2,8 2,8	5,6	-	11,9	23,1	26,1	46,3	30
1,00	0,27	1,08 1,08	0,90	-	0,93	0,60	0,96	0,65	1,17
56	-	-	-	-	-	-	-	-	-
56,00	-	-	-	-	-	-	-	-	-
19,2	5,2	24,6 22,5	17,3	20,5	20,4	11,5	16,7	11,3	19,3
19,2	19,2	-	19,2	-	-	19,2	17,4	17,4	16,5
1 125	-	-	-	-	-	-	-	-	-

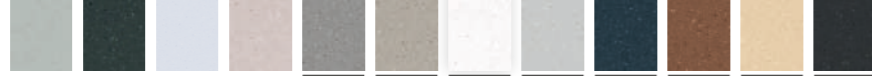

Farben | colors



Dxxxx866 PEI 4
Shadow
dunkelgrau | dark grey



Dxxxx867 PEI 4
Taupe
grau-beige | grey-beige



Dxxxx864 PEI 5
Paper
weiß-grau | white-grey



Dxxxx865 PEI 5
Cement
grau | grey



Dxxxx870 PEI 4
Storm
schwarz-blau | black-blue



Dxxxx869 PEI 4
Cotto
braun-rot | brown-red

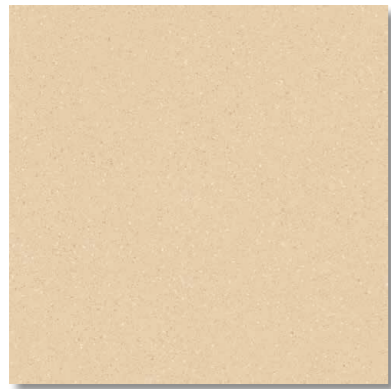

Dxxxx868 PEI 4
Sand
ocker | ochre

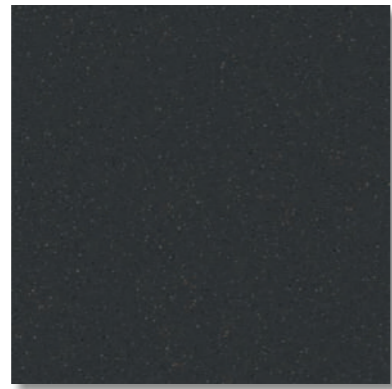

Dxxxx871 PEI 4
Coal
braun-schwarz | brown-black



Oberflächen | surfaces



ABS R10/B
 $\mu \geq 0,6$



R11/B
 $\mu \geq 0,6$



Formteile | special pieces

Stufe | step tile | DCPVF... | 298x1198x10 mm*

DCPVD... | 298x1198x9 mm**

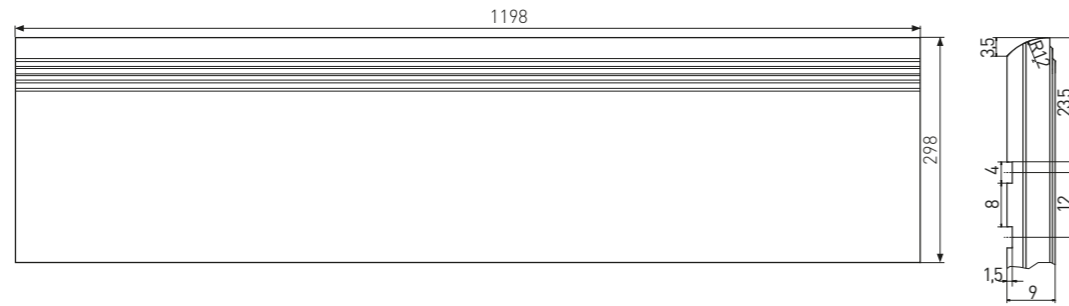

Stufe | step tile | DCPSR... | 298x598x9 mm

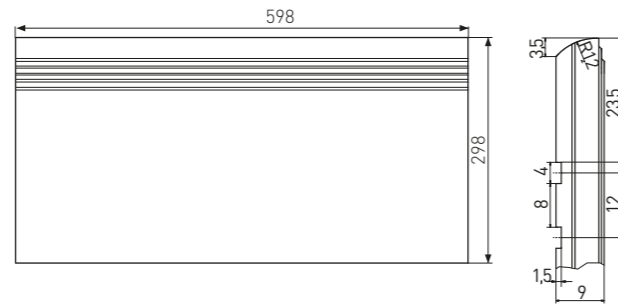
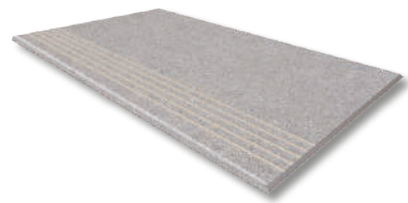

Stufenformteil | special step tile | DCFVF... | 298x1198x10 mm*

DCFVD... | 298x1198x9 mm**

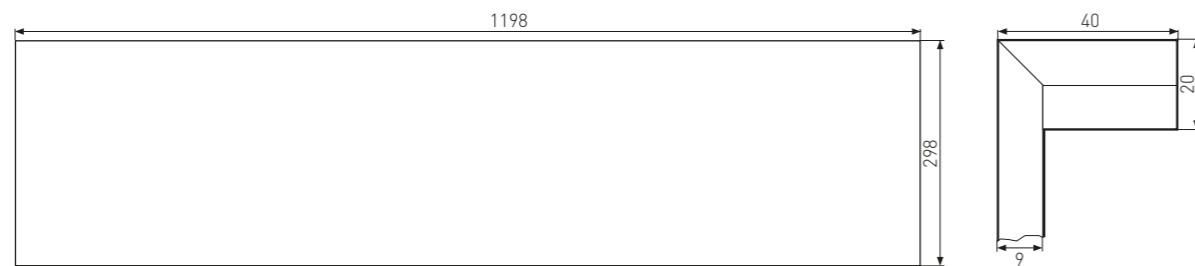

Socket | skirting plinth | DSA99... | 1198x72x9 mm

News

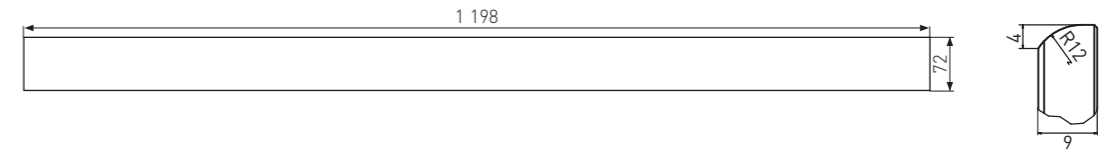

Socket | skirting plinth | DSAS3... | 598x72x9 mm

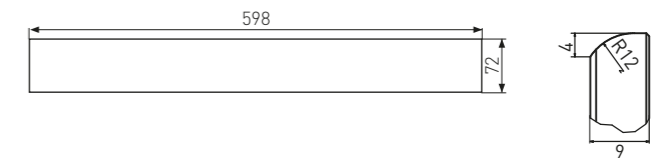

Socket | skirting plinth | DSAPS... | 448x85x8 mm

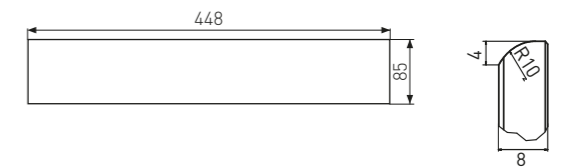

Socket | skirting plinth | DSAJ8... | 298x72x8 mm

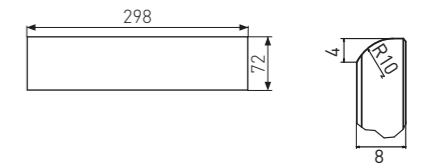

Hohlkehsocket | cove skirting | DSPJT... | 298x110x8 mm

News

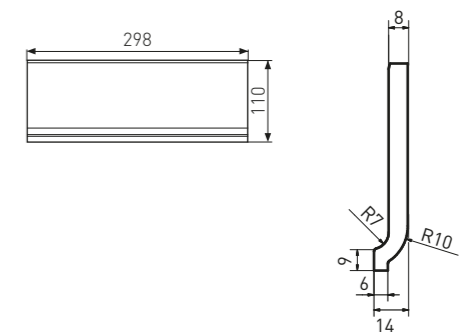

















* Verfügbar solange der Vorrat reicht | Available while stocks last

** Neues Produkt in 9 mm Stärke im Laufe des Jahres 2025 verfügbar | New product in 9 mm thickness available during 2025





Produkt product				 
EN 14411 - L BIII	Wandfliese wall tile	Wandfliese wall tile	Wandfliese wall tile	Mosaik sheet 30x30 cm mosaic sheet 30x30cm
	30x60 	30x60	20x40	5x5 
	298x598x8	298x598x8	198x398x7	48x48x7
Oberfläche surface	matt	matt	matt	matt
Farbe color				
Mint hellgrün light green	WAKVK862 ○ 500 m ²	WADVK862 ○ 480 m ²	WADMB862 ○ 400 m ²	WDM05862 ○ 250 Netz
Botanic dunkelgrün dark green	WAKVK863 ○ 500 m ²	WADVK863 ○ 480 m ²	WADMB863 ○ 400 m ²	WDM05863 ○ 250 Netz
Aqua hellblau light blue	WAKVK861 ○ 500 m ²	WADVK861 ○ 480 m ²	WADMB861 ○ 400 m ²	WDM05861 ○ 250 Netz
Nude hellrosa light pink	WAKVK860 ○ 500 m ²	WADVK860 ○ 480 m ²	WADMB860 ○ 400 m ²	WDM05860 ○ 250 Netz
Shadow dunkelgrau dark grey	WAKVK866 ○ 500 m ²	WADVK866 ○ 480 m ²	WADMB866 ○ 400 m ²	WDM05866 ○ 250 Netz
Taupe grau-beige grey-beige	WAKVK867 ○ 500 m ²	WADVK867 ○ 480 m ²	WADMB867 ○ 400 m ²	WDM05867 ○ 250 Netz
Paper weiß-grau white-grey	WAKVK864 ○ 500 m ²	WADVK864 ○ 480 m ²	WADMB864 ○ 400 m ²	WDM05864 ○ 250 Netz
Cement grau grey	WAKVK865 ○ 500 m ²	WADVK865 ○ 480 m ²	WADMB865 ○ 400 m ²	WDM05865 ○ 250 Netz
logistische Daten logistic information				
	8	20	4	
	5,56	12,5	11	
	1,44	1,60	0,36	
	40	48	-	
	57,60	76,80	-	
	21,3	20,6	4,8	
	14,8	12,9	12,9	
	876	1 016	-	



Farben | colors

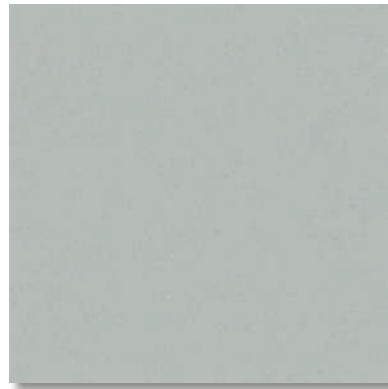

Wxxxx862
Mint
hellgrün | light green



Wxxxx863
Botanic
dunkelgrün | dark green

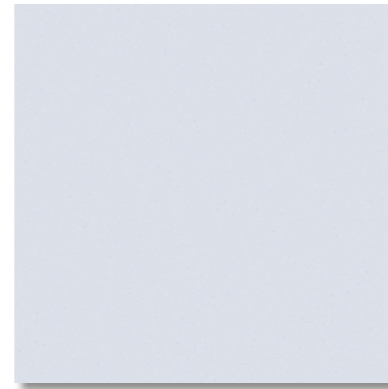

Wxxxx861
Aqua
hellblau | light blue



Wxxxx860
Nude
hellrosa | light pink

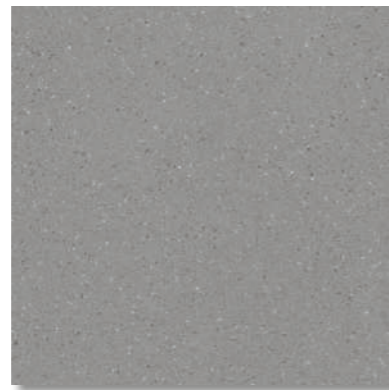

Wxxxx866
Shadow
dunkelgrau | dark grey



Wxxxx867
Taupe
grau-beige | grey-beige

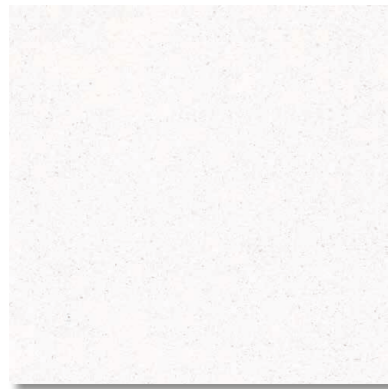

Wxxxx864
Paper
weiß-grau | white-grey



Wxxxx865
Cement
grau | grey



Oberflächen | surfaces



matt

Dekore | decoration



Dekor | decor | 98x298x8 mm



GARJD862
 ○ 670 l m²
 relief glossy
 color **mint**
 hellgrün | light green



GARJD863
 ○ 670 l m²
 relief glossy
 color **botanic**
 dunkelgrün | dark green



GARJD861
 ○ 670 l m²
 relief glossy
 color **aqua**
 hellblau | light blue



GARJD860
 ○ 670 l m²
 relief glossy
 color **nude**
 hellrosa | light pink



GARJD867
 ○ 670 l m²
 relief glossy
 color **taupe**
 grau-beige | grey-beige



GARJD864
 ○ 670 l m²
 relief glossy
 color **paper**
 weiß-grau | white-grey



GARJD865
 ○ 670 l m²
 relief glossy
 color **cement**
 grau | grey



GARJD870
 ○ 670 l m²
 relief glossy
 color **storm**
 schwarz-blau | black-blue



GARJD869
 ○ 670 l m²
 relief glossy
 color **cotto**
 braun-rot | brown-red

RAKO Object



Dekor | decor | **Ornamento** | 598x598x9 mm

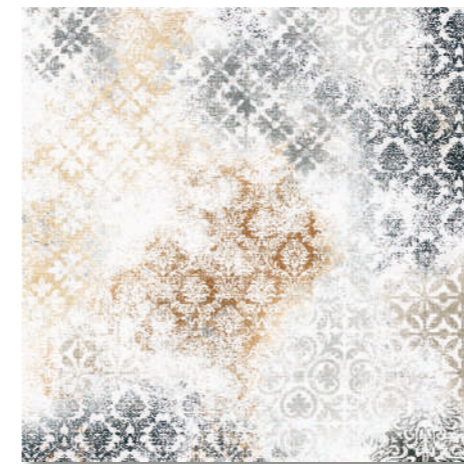

DAK62872
 ○ 560 l m²
 matt |

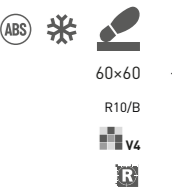

Produkt | product



Bodenfliese floor tile	10x30	98x298x8	EN 14411 - H B1b	24	33,3	0,72	66	47,52	12,5	17,3	851
Bodenfliese floor tile	60x60	598x598x9	EN 14411 - G B1a	4	2,8	1,44	32	46,08	27,6	19,2	910

Die Produktverpackung enthält zufällige Designmöglichkeiten. | The products are deliberately mixed in packing to include a random selection of designs. Empfohlene Formatkombinationen 10x30 siehe Seite 522-523. | Recommended combinations of modular sizes 10x30 see pages 522-523.



Dekore | decoration

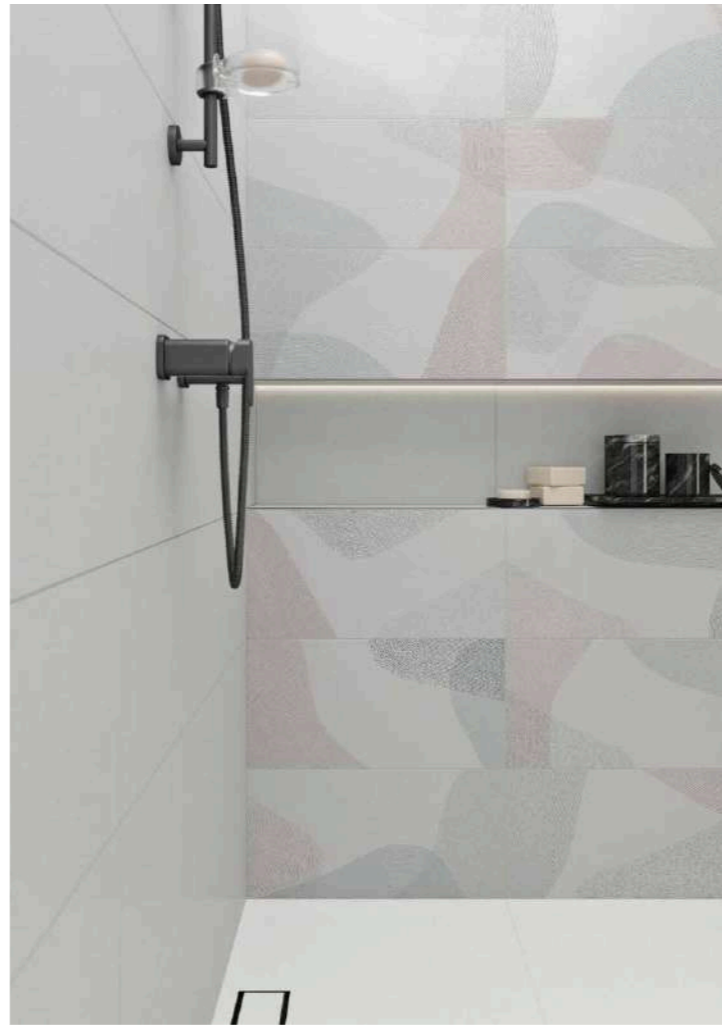

Dekor | decor | **Ornamento** | 298×598×8 mm



WAKVK871
 ○ 500 | m²
 matt | **v4** |



News



Dekor | decor | **Game** | 298×598×8 mm



WADVK872
 ○ 480 | m²
 matt | **v3**



30×60
v3

Dekor | decor | **Onsen** | 298×598×8 mm



WAKVK873
 ○ 500 | m²
 matt | **v3** |



Dekor | decor | **Herbs** | 298×598×8 mm



WIKVK141
 ○ 920 | set
 matt |

WIDVK141
 ○ 920 | set
 matt

(SET)

Produkt | product



Dekor 1 set/4 St | decor 1 set/4 pcs
 Wandfliese | wall tile

30×60
 30×60

298×598×8
 298×598×8

EN 14411 - L BIII
 EN 14411 - L BIII

4
 8

5,56
 5,56

0,72
 1,44

-
 40

-
 57,60

10,7
 21,3

14,8
 14,8

-
 876

Die Produktverpackung enthält zufällige Designmöglichkeiten. | The products are deliberately mixed in packing to include a random selection of designs.