



Qualität, Funktionalität und Beständigkeit – das waren und sind wesentliche Vorteile der Serie Taurus GRANIT. Die breite Produktpalette, die an die Serien ColorONE und ColorTWO anknüpft, unterstützt das kreative und variable Potential individueller Projekte, einschließlich einer Reihe von Sonderzubehör. Alle Oberflächen erfüllen die hohen technischen Anforderungen der internationalen Normen.

„Bewährte Qualität.“















Quality, functionality, and durability were and are the important benefits of the Taurus GRANIT series. The wide range, building on the ColorONE and ColorTWO assortments, supports the creative and variable potential of the individual projects, including a range of special supplies. All surfaces meet the high technical requirements of international standards.

„Proven quality.“





Produkt product					
EN 14411 - G Blä	Bodenfliese floor tile	Bodenfliese floor tile	Bodenfliese floor tile		
	60×60 R	30×60 R	30×30		
	598×598×10* 598×598×9**	298×598×10* 298×598×9**	298×298×8		
Oberfläche surface	matt	matt	matt	relief SR7	relief SRM
Rutschfestigkeit slip resistance	R10/B	R10/B	R10/B	R11/B	R12/B
Reibungskoeffizient - trocken sliding friction coefficient - dry	$\mu \geq 0,6$	$\mu \geq 0,6$	$\mu \geq 0,6$	$\mu \geq 0,7$	$\mu \geq 0,7$
Farbe color					
69 Rio Negro schwarz black	TAK63069* TAK62069** ○ 670 m ²	TAKSE069* TAKSR069** ○ 530 m ²	TAA34069 ○ 420 m ²	TR734069 ○ 470 m ²	TRM34069 ○ 470 m ²
65 Antracit anthrazit-grau anthracite-grey	TAK63065* TAK62065** ○ 640 m ²	TAKSE065* TAKSR065** ○ 510 m ²	TAA34065 ○ 400 m ²	TR734065 ○ 450 m ²	TRM34065 ○ 450 m ²
76 Nordic grau grey	TAK63076* TAK62076** ○ 560 m ²	TAKSE076* TAKSR076** ○ 490 m ²	TAA34076 ○ 370 m ²	TR734076 ○ 440 m ²	TRM34076 ○ 440 m ²
78 Sierra hellgrau light grey	TAK63078* TAK62078** ○ 690 m ²	TAKSE078* TAKSR078** ○ 600 m ²	TAA34078 ○ 530 m ²		
60 Alaska weiß white	TAK63060* TAK62060** ○ 740 m ²	TAKSE060* TAKSR060** ○ 600 m ²	TAA34060 ○ 530 m ²		
62 Sahara beige beige	TAK63062* TAK62062** ○ 640 m ²	TAKSE062* TAKSR062** ○ 510 m ²	TAA34062 ○ 400 m ²		
61 Tunis dunkelbeige dark beige	TAK63061* TAK62061** ○ 560 m ²	TAKSE061* TAKSR061** ○ 490 m ²	TAA34061 ○ 370 m ²	TR734061 ○ 440 m ²	TRM34061 ○ 440 m ²
68 Cuba braun-grau brown-grey	TAK63068* TAK62068** ○ 640 m ²	TAKSE068* TAKSR068** ○ 510 m ²	TAA34068 ○ 400 m ²	TR734068 ○ 450 m ²	
74 Gobi gelb yellow			TAA34074 ○ 420 m ²		
82 Jura rot red			TAA34082 ○ 420 m ²		
80 Oaza grün green			TAA34080 ○ 420 m ²		
75 Biskay blau blue			TAA34075 ○ 400 m ²		
logistische Daten logistic information					
	3 4	6 7	14		
	2,8 2,8	5,6 5,6	11,0		
	1,08 1,44	1,08 1,26	1,27		
	32 32	40 40	48		
	34,56 46,08	43,20 50,40	60,96		
	23,7 29,1	23,7 24,2	21,6		
	21,9 20,2	21,9 19,2	17,0		
	782 955	971 993	1 062		

* Verfügbar solange der Vorrat reicht | Available while stocks last

** Neues Produkt in 9 mm Stärke im Laufe des Jahres 2025 verfügbar | New product in 9 mm thickness available during 2025

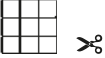
				
Bodenfliese floor tile	Bodenfliese floor tile mosaic sheet 30×30 cm	Mosaik sheet 30×30 cm mosaic sheet 30×30 cm		
20×20	10×10	5×5 R		
198×198×8	98×98×8	48×48×8		
matt	relief SR7	relief SRM	matt	matt
R10/B	R11/B	R12/B	R10/B	R10/B
$\mu \geq 0,6$	$\mu \geq 0,7$	$\mu \geq 0,7$	$\mu \geq 0,6$	$\mu \geq 0,6$
TAA25069 ○ 470 m ²	TR725069 ○ 520 m ²	TRM25069 ○ 520 m ²	TAA11069 ○ 790 m ²	TDM05069 ○ 300 Netz
TAA25065 ○ 450 m ²	TR725065 ○ 490 m ²	TRM25065 ○ 490 m ²	TAA11065 ○ 790 m ²	TDM05065 ○ 300 Netz
TAA25076 ○ 440 m ²	TR725076 ○ 480 m ²	TRM25076 ○ 480 m ²	TAA11076 ○ 790 m ²	TDM05076 ○ 300 Netz
			TAA11078 ○ 790 m ²	TDM05078 ○ 300 Netz
			TAA11060 ○ 790 m ²	TDM05060 ○ 300 Netz
TAA25062 ○ 450 m ²			TAA11062 ○ 790 m ²	TDM05062 ○ 300 Netz
TAA25061 ○ 440 m ²	TR725061 ○ 480 m ²	TRM25061 ○ 480 m ²	TAA11061 ○ 790 m ²	TDM05061 ○ 300 Netz
TAA25068 ○ 450 m ²	TR725068 ○ 490 m ²		TAA11068 ○ 790 m ²	TDM05068 ○ 300 Netz
	32		12	4
	25,0		11,0	11,0
	1,28		1,09	0,36
	54		56	-
	69,12		61,04	-
	21,8		18,5	6,0
	17,0		17,0	17,0
	1 200		1 063	-











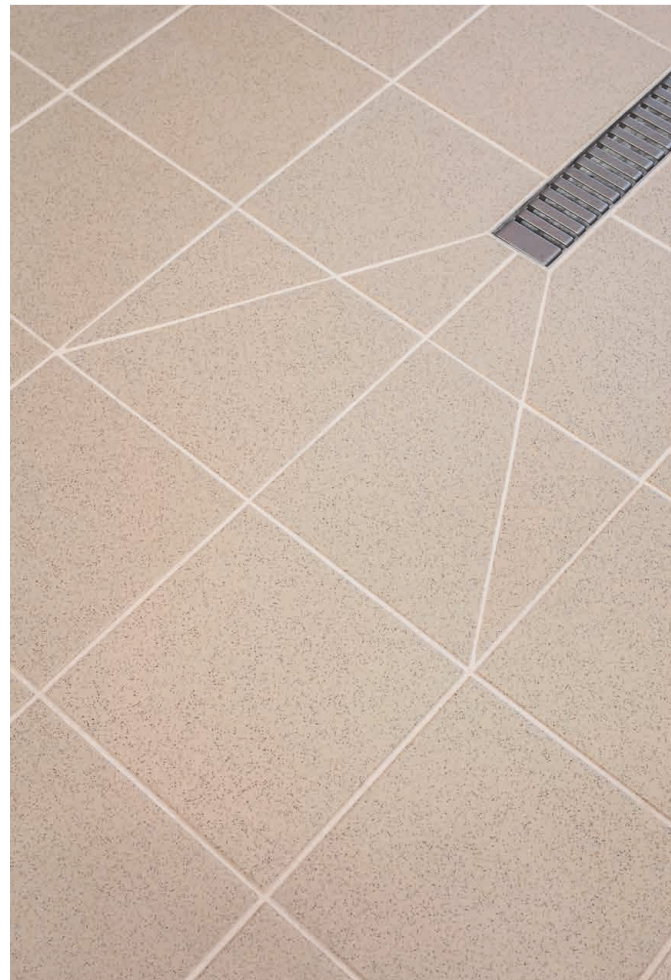





Produkt product						
EN 14411 - G Bla STO No. 030 - 059824	Stufe step tile	Stufe step tile	Außenstufe ext. step tile	Sockel skirting plinth	Sockel skirting plinth	Französischer Sockel french skirting plinth
	30×60 R	30×30	30×30	60×9,5* 60×7,2** R	30×8	30×8
	298×598×10* 298×598×9**	298×298×8	298×298×8	598×95×10* 598×72×9**	298×80×8	298×80×8
Oberfläche surface	matt	matt	relief SR7	matt	matt	matt
Rutschfestigkeit slip resistance	R10/B	R10/B	R11/B			
Reibungskoeffizient - trocken sliding friction coefficient - dry	μ ≥ 0,7	μ ≥ 0,7	μ ≥ 0,7			
Farbe color						
69 Rio Negro schwarz black	TCPSE069* TCPSR069** ○ 270 St	TCA34069 ○ 150 St	TCV34069 ○ 190 St	TSASZ069* TSAS3069** ○ 180 St	TSAKF069 ○ 110 St	TSFKF069 ○ 120 St
65 Antracit anthrazit-grau anthracite-grey	TCPSE065* TCPSR065** ○ 270 St	TCA34065 ○ 150 St	TCV34065 ○ 190 St	TSASZ065* TSAS3065** ○ 180 St	TSAKF065 ○ 110 St	TSFKF065 ○ 120 St
76 Nordic grau grey	TCPSE076* TCPSR076** ○ 270 St	TCA34076 ○ 150 St	TCV34076 ○ 190 St	TSASZ076* TSAS3076** ○ 180 St	TSAKF076 ○ 110 St	TSFKF076 ○ 120 St
78 Sierra hellgrau light grey	TCPSE078* TCPSR078** ○ 270 St	TCA34078 ○ 150 St		TSASZ078* TSAS3078** ○ 180 St	TSAKF078 ○ 110 St	TSFKF078 ○ 120 St
60 Alaska weiß white	TCPSE060* TCPSR060** ○ 270 St	TCA34060 ○ 150 St		TSASZ060* TSAS3060** ○ 180 St	TSAKF060 ○ 110 St	
62 Sahara beige beige	TCPSE062* TCPSR062** ○ 270 St	TCA34062 ○ 150 St		TSASZ062* TSAS3062** ○ 180 St	TSAKF062 ○ 110 St	TSFKF062 ○ 120 St
61 Tunis dunkelbeige dark beige	TCPSE061* TCPSR061** ○ 270 St	TCA34061 ○ 150 St	TCV34061 ○ 190 St	TSASZ061* TSAS3061** ○ 180 St	TSAKF061 ○ 110 St	TSFKF061 ○ 120 St
68 Cuba braun-grau brown-grey	TCPSE068* TCPSR068** ○ 270 St	TCA34068 ○ 150 St		TSASZ068* TSAS3068** ○ 180 St	TSAKF068 ○ 110 St	TSFKF068 ○ 120 St
74 Gobi gelb yellow		TCA34074 ○ 150 St			TSAKF074 ○ 110 St	
82 Jura rot red		TCA34082 ○ 150 St			TSAKF082 ○ 110 St	
80 Oaza grün green		TCA34080 ○ 150 St			TSAKF080 ○ 110 St	
75 Biskay blau blue		TCA34075 ○ 150 St			TSAKF075 ○ 110 St	
logistische Daten logistic information						
	6 5	14	13	13 14	23	22
	5,6 5,6	11,0	11,0	17,5 23,1	42,0	42,0
	1,08 0,9	1,27	1,18	0,74 0,6	0,55	0,53
	-	48	52	-	-	-
	-	60,96	61,36	-	-	-
	23,7 17,3	21,7	19,5	16,2 11,5	9,4	9,0
	-	17,0	17,0	-	17,0	17,0
	-	1 062	1 039	-	-	-

* Verfügbar solange der Vorrat reicht | Available while stocks last

** Neues Produkt in 9 mm Stärke im Laufe des Jahres 2025 verfügbar | New product in 9 mm thickness available during 2025

Hohlkehlssockel cove skirting	Hohlkehlssockel cove skirting	Innenecke Hohlkehlssockel inside corner skirting plinth	Außenecke Hohlkehlssockel outside corner skirting plinth
30×8	20×8	2,3×8	2,3×8
298×80×8	198×80×8	80×23×10	80×23×7
matt	matt	S	S
R10/B	R10/B		
μ ≥ 0,6	μ ≥ 0,6		
TSPKF069 ○ 130 St	TSPF6069 ○ 110 St	TSIRH069 ○ 240 St	TSERH069 ○ 240 St
TSPKF065 ○ 130 St	TSPF6065 ○ 110 St	TSIRH065 ○ 240 St	TSERH065 ○ 240 St
TSPKF076 ○ 130 St	TSPF6076 ○ 110 St	TSIRH076 ○ 240 St	TSERH076 ○ 240 St
TSPKF078 ○ 130 St		TSIRH078 ○ 240 St	TSERH078 ○ 240 St
TSPKF062 ○ 130 St	TSPF6062 ○ 110 St	TSIRH062 ○ 240 St	TSERH062 ○ 240 St
TSPKF061 ○ 130 St	TSPF6061 ○ 110 St	TSIRH061 ○ 240 St	TSERH061 ○ 240 St
TSPKF068 ○ 130 St	TSPF6068 ○ 110 St	TSIRH068 ○ 240 St	TSERH068 ○ 240 St
19	28	150	100
42,0	62,5	-	-
0,46	0,45	-	-
-	-	-	-
-	-	-	-
7,8	7,6	4,5	3,5
17,0	17,0	-	-
-	-	-	-



Produkt product			
STO No. 030 - 059824	Duschtasseneckstein shower piece corner	Duschtassenstein shower piece continuous	Hohlkehlsokkel-Rinne skirting groove
	10×10	10×10	20×7
	98×98×8	98×98×8	198×70×8
Oberfläche surface	matt	matt	S
Rutschfestigkeit slip resistance	R10/B	R10/B	
Reibungskoeffizient - trocken sliding friction coefficient - dry	$\mu \geq 0,6$	$\mu \geq 0,6$	
Farbe color			
69 Rio Negro schwarz black	TTR11069 ○ 190 St	TTP11069 ○ 190 St	TSZEF069 ○ 130 St
65 Antracit anthrazit-grau anthracite-grey	TTR11065 ○ 190 St	TTP11065 ○ 190 St	TSZEF065 ○ 130 St
76 Nordic grau grey	TTR11076 ○ 190 St	TTP11076 ○ 190 St	TSZEF076 ○ 130 St
78 Sierra hellgrau light grey			
60 Alaska weiß white			
62 Sahara beige beige			
61 Tunis dunkelbeige dark beige	TTR11061 ○ 190 St	TTP11061 ○ 190 St	TSZEF061 ○ 130 St
68 Cuba braun-grau brown-grey			
74 Gobi gelb yellow			
82 Jura rot red			
80 Oaza grün green			
75 Biskay blau blue			
logistische Daten logistic information			
	16	16	24
	100,0	100,0	71,0
	0,16	0,16	0,34
	-	-	-
	-	-	-
	3,5	3,2	7,2
	-	-	21,2
	-	-	-



Farben | colors

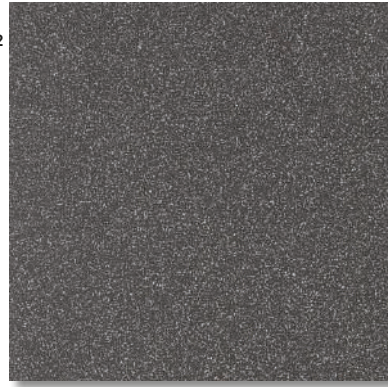

69 Rio Negro
schwarz | black



65 Antracit
anthrazit-grau | anthracite-grey



76 Nordic
grau | grey



68 Cuba
braun-grau | brown-grey



74 Gobi
gelb | yellow



82 Jura
rot | red



78 Sierra
hellgrau | light grey

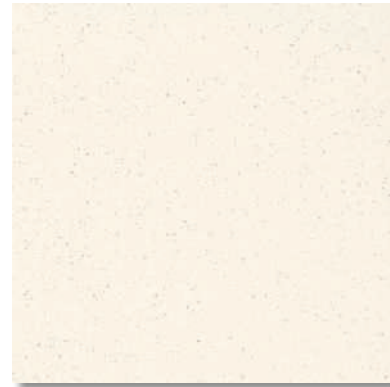

60 Alaska
weiß | white

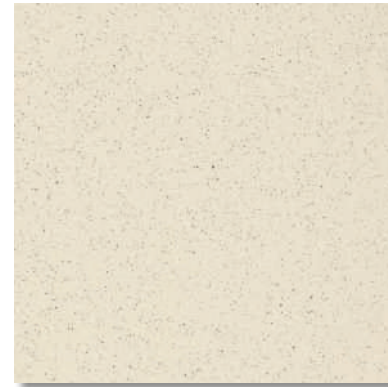

62 Sahara
beige | beige

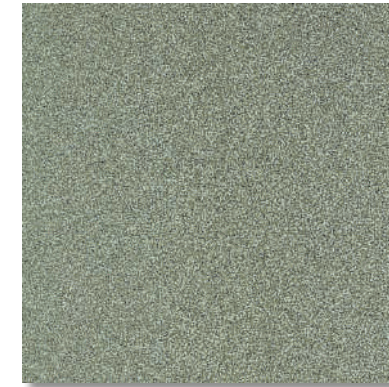

80 Oaza
grün | green

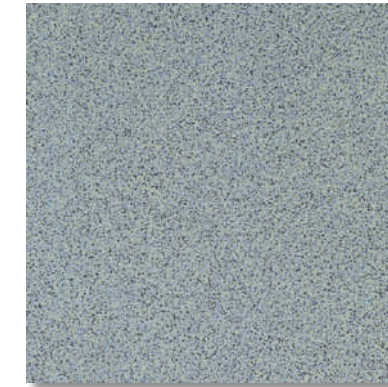

75 Biskay
blau | blue



61 Tunis
dunkelbeige | dark beige



Oberflächen | surfaces



matt

R10/B
 $\mu \geq 0,6$



relief
 SR7

R11/B
 $\mu \geq 0,7$

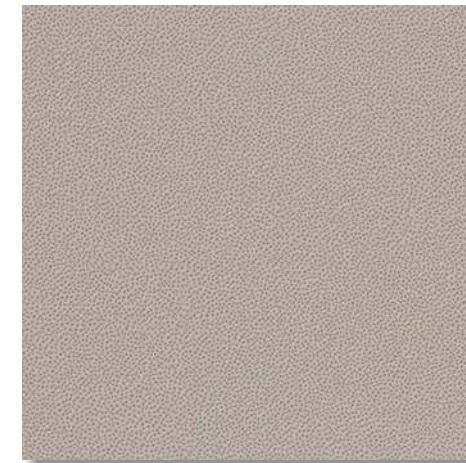

relief
 SRM

R12/B
 $\mu \geq 0,7$



Formteile | special pieces

Stufe | step tile | TCPSE... | 298x598x10 mm*
 TCPSR... | 298x598x9 mm**

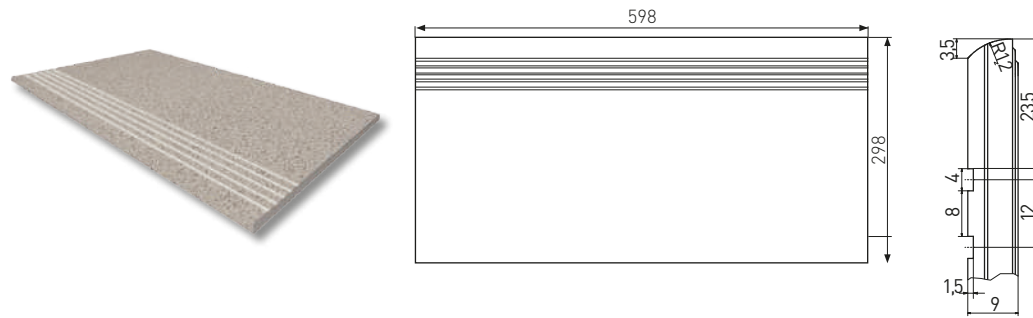

Stufe | step tile | TCA34... | 298x298x8 mm

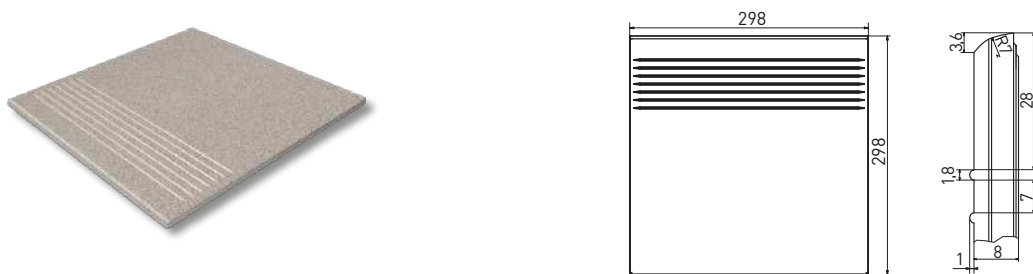

Außenstufe | outside step tile | TCV34... | 298x298x8 mm

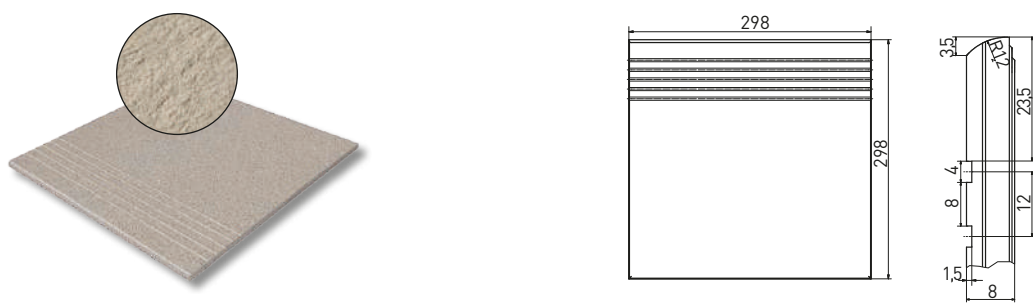

Socket | skirting plinth | TSASZ... | 598x95x10 mm*
 TSAS3... | 598x72x9 mm **

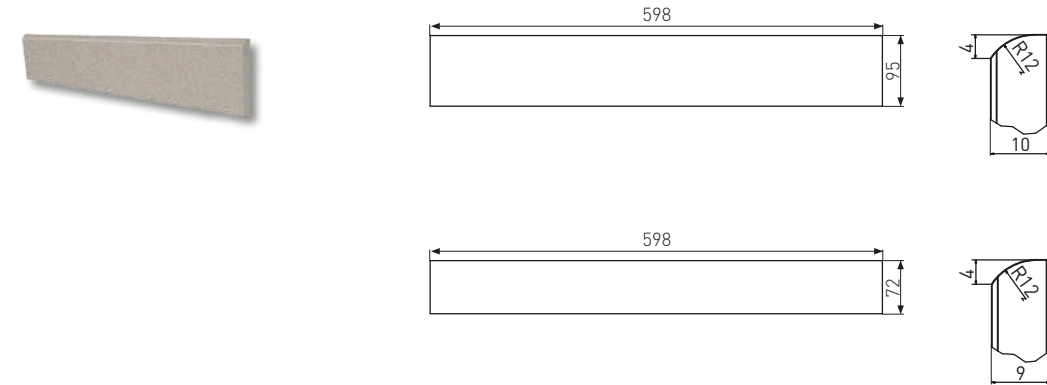

Socket | skirting plinth | TSAKF... | 298x80x8 mm

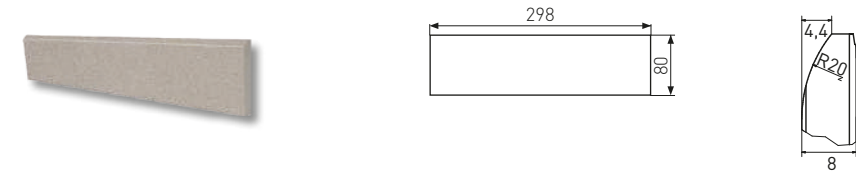

Französischer Socket | french skirting | TSFKF... | 298x80x8 mm

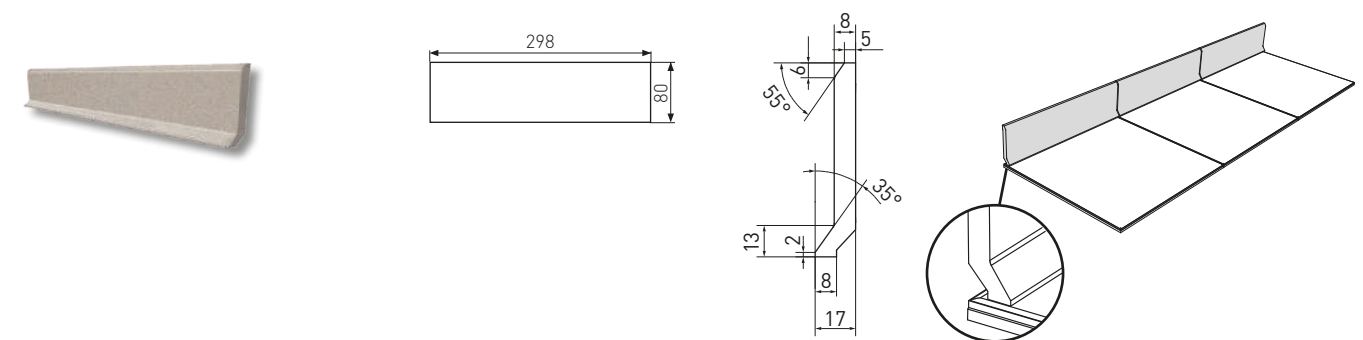

* Verfügbar solange der Vorrat reicht | Available while stocks last

** Neues Produkt in 9 mm Stärke im Laufe des Jahres 2025 verfügbar | New product in 9 mm thickness available during 2025



Formteile | special pieces

Hohlkehlsöckel | cove skirting | **TSPKF...** | 298x80x8 mm

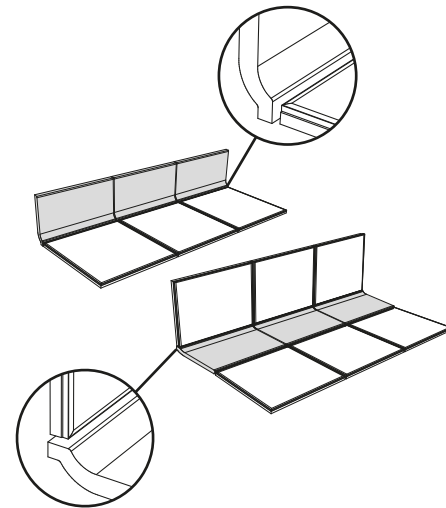
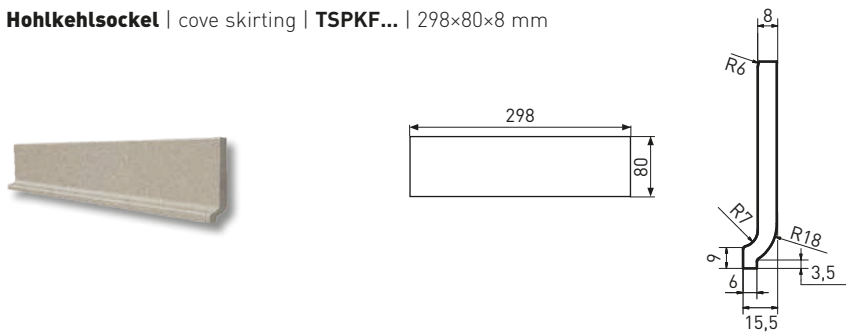

Duschtasseneckstein | shower piece - corner | **TTR11...** | 98x98x8 mm

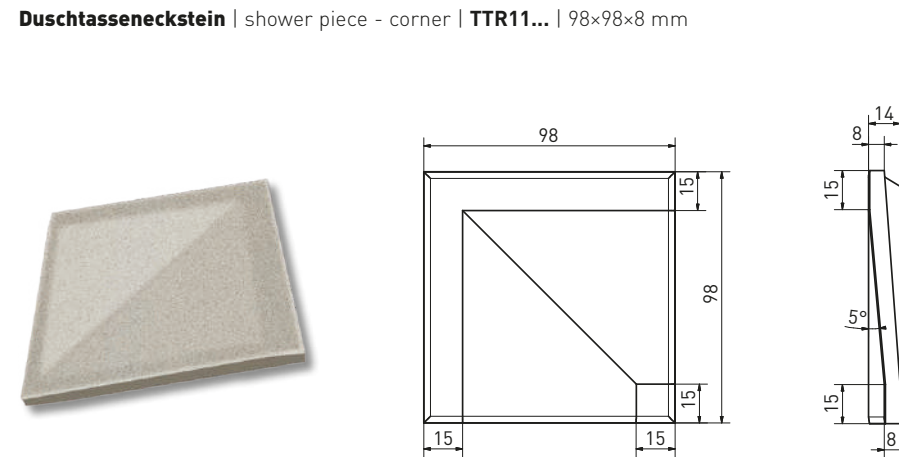

Innenecke Hohlkehlsöckel | inside corner cove skirting | **TSIRH...** | 80x23x10 mm

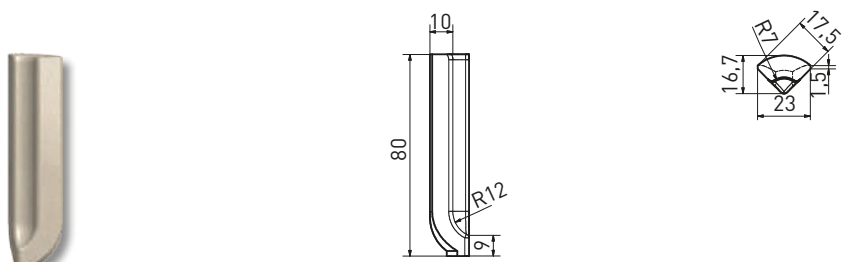

Duschtassenstein | shower piece - continuous | **TTP11...** | 98x98x8 mm

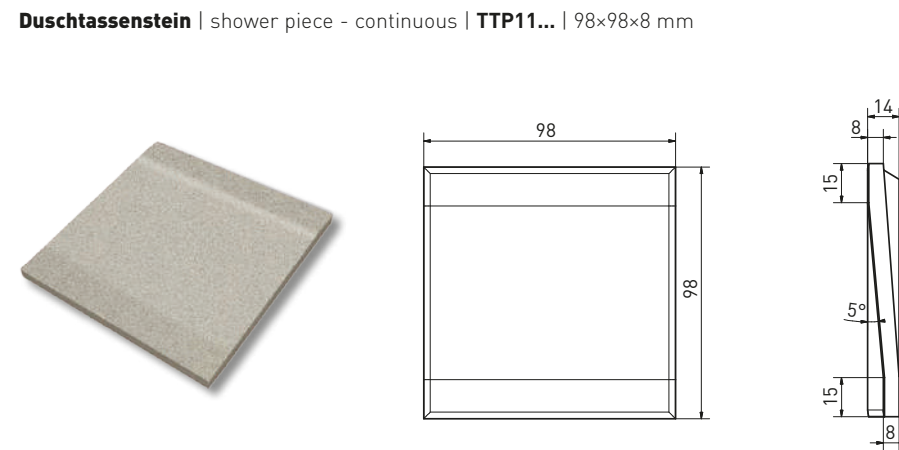

Außenecke Hohlkehlsöckel | outside corner cove skirting | **TSERH...** | 80x23x7 mm

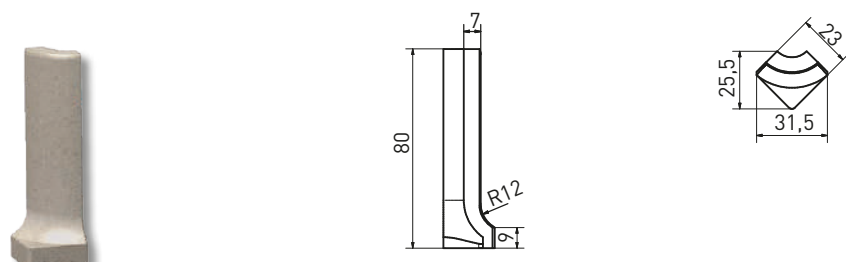

Hohlkehlsöckel-Rinne | skirting - groove | **TSZEF...** | 198x70x8 mm

