

RAKO

Home

RAKO

Object

News

EINLEITUNG INTRODUCTION	8	MAJOLIKA	401
ALBA	250	MANO	402
BASE	258	MARMO	403
BETONICO	264	METRO	404
BETONICO OUTDOOR	286	MIXTONE	202
BLEND	290	MIXTONE OUTDOOR	206
BLOCK	38	NEXT	408
BLOSSOM	248	ONYX	412
BOA	294	PIAZZETTA	416
BOARD	296	PIAZZETTA OUTDOOR	422
BRICOLA	302	PINO	208
BRICOLA OUTDOOR	308	PINO OUTDOOR	214
CASTONE	310	PLANK	216
CASTONE OUTDOOR	320	PLAY	116
CAVA	324	PLYWOOD	424
CEMENTO	328	POEM	430
COLOR ONE	102	POOL	136
COLOR TWO	120	PORFIDO	432
COMO	330	QUARZIT	440
COMPILA	16	QUARZIT OUTDOOR	450
CONCEPT CONCEPT PLUS	332	RAVE	222
CORE	156	RAVE OUTDOOR	230
CORE OUTDOOR	164	REBEL	454
CRAFT	170	REBEL OUTDOOR	466
DALE	176	ROOF	468
DECO	342	RUSH	470
EASY	343	SALOON	474
ERA	344	SHADE	232
EXTRA	346	SIENA	480
FLASH	368	SPECTRA	484
FLY	186	SYSTEM	486
FORM	372	TAURUS COLOR	88
FORM PLUS	374	TAURUS GRANIT	66
GARDA	376	TAURUS INDUSTRIAL	82
CHARME	380	TESS	488
KAAMOS	56	TEXTILE	490
KAAMOS INDUSTRIAL	60	TOPO	492
KAAMOS OUTDOOR	60	TOUCH	238
KOMET	381	UNIVERSAL	496
LAMPEA	382	UP	497
LAZIO	384	VALS	502
LEVANTE	386	VALS OUTDOOR	508
LIMESTONE	390	VEIN	510
LINKA	394	VIA	514
LINT	398	TECHNISCHE INFORMATIONEN	
LUCIE	400	TECHNICAL INFORMATION	516



40x120

- BETONICO266
- CAVA325
- COLOR ONE104
- ONYX413
- ROOF469
- SYSTEM486



30x60

- BASE261
- BETONICO268
- BLOCK51
- BOA295
- CASTONE313
- CAVA325
- COLOR ONE105
- COMPILA31
- CONCEPT | CONCEPT PLUS332
- DALE179
- EXTRA349
- FLASH369
- FLY189
- LAMPEA383
- LAZIO384
- LEVANTE387
- LINT399
- MANO402
- METRO407
- NEXT409
- ONYX413
- PIAZZETTA417
- PINO210
- POEM431
- RUSH471
- SALOON475
- SPECTRA485
- SYSTEM486
- TOPO493
- UNIVERSAL496
- UP497
- VEIN513



30x90

- BASE260
- BLOSSOM249
- COLOR ONE104
- CONCEPT | CONCEPT PLUS332
- DALE179
- FLASH369
- LAZIO384
- PLANK219
- SYSTEM486
- VEIN513



20x60

- BLEND290
- COLOR ONE106
- CONCEPT | CONCEPT PLUS334
- FORM PLUS374
- GARDA377
- CHARME380
- MAJOLIKA401
- SYSTEM487

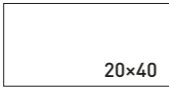

20x40

- COLOR ONE107
- COMPILA31
- CONCEPT | CONCEPT PLUS336
- EASY343
- EXTRA352
- FORM PLUS375
- GARDA378
- LAZIO384
- LEVANTE387
- PLAY119
- SYSTEM487
- TESS489
- TEXTILE491
- UP500



25x33

- COLOR ONE107
- CONCEPT | CONCEPT PLUS338
- MARMO403
- SYSTEM487
- UNIVERSAL496



20x25

- COLOR ONE108
- LUCIE400
- MARMO403
- SYSTEM487
- UNIVERSAL496



20x20

- COLOR ONE108



15x20

- COLOR ONE108
- KOMET381



15x15

- COLOR ONE109

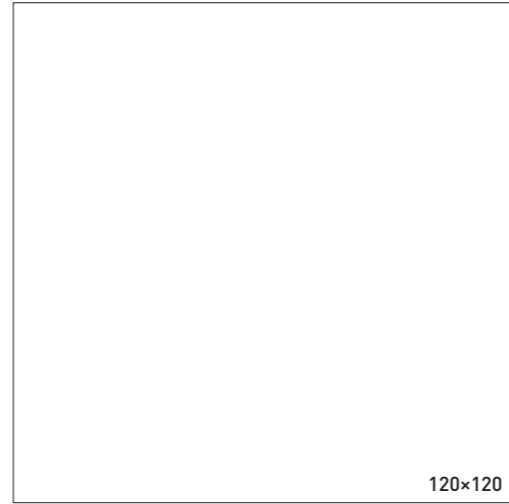

120x120

- BETONICO270
- CASTONE314
- COMPILA22
- FLY ①190
- RAVE224
- TOUCH240



60x120

- ALBA252
- BETONICO274
- BETONICO OUTDOOR286
- BLOCK ①40
- BRICOLA304
- CASTONE OUTDOOR320
- COMPILA22
- CORE ①158
- CORE OUTDOOR ①166
- CRAFT172
- DALE ①180
- EXTRA354
- FLY ①194
- MIXTONE203
- MIXTONE OUTDOOR207
- PINO OUTDOOR215
- PLYWOOD426
- PORFIDO434
- QUARZIT OUTDOOR450
- RAVE226
- REBEL456
- SHADE234
- TOUCH242
- VALS504



30x120

- BOARD298
- SALOON476



20x120

- BOARD298
- BRICOLA304
- PINO211
- PLANK219
- PLYWOOD427
- SALOON476

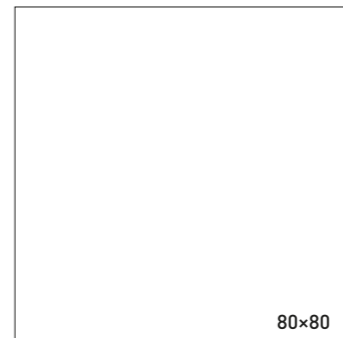

80x80

- BETONICO276
- BLOCK ①40
- CASTONE316
- EXTRA356
- FLY ①196
- KAAMOS ①58
- MIXTONE203
- QUARZIT443
- REBEL458

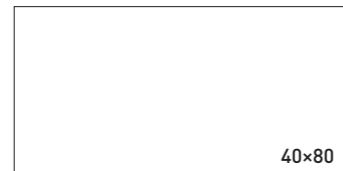

40x80

- EXTRA356
- BLOCK ①40
- KAAMOS ①58
- QUARZIT443
- REBEL458



20x80

- PINO211
- SALOON476

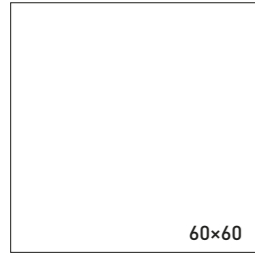

ALBA.....	255
BASE.....	262
BETONICO.....	278
BETONICO OUTDOOR.....	289
BLEND.....	292
BLOCK ⊕.....	40
BRICOLA OUTDOOR.....	309
CASTONE.....	317
CASTONE OUTDOOR.....	323
CAVA.....	327
CEMENTO.....	328
COMPILA.....	22
CORE ⊕.....	160
CORE OUTDOOR ⊕.....	169
CRAFT.....	172
DALE ⊕.....	182
DECO.....	342
EXTRA.....	360
FLASH.....	371
FLY ⊕.....	198
KAAMOS ⊕.....	58
KAAMOS INDUSTRIAL ⊕.....	61
KAAMOS OUTDOOR ⊕.....	61
LEVANTE.....	389
LIMESTONE.....	390
LINKA.....	396
MIXTONE.....	203
MIXTONE OUTDOOR.....	207
ONYX.....	415
PIAZZETTA ⊕.....	418
PIAZZETTA OUTDOOR ⊕.....	423
PORFIDO.....	436
QUARZIT.....	445
QUARZIT OUTDOOR.....	453
RAVE.....	227
RAVE OUTDOOR.....	231
REBEL.....	460
REBEL OUTDOOR.....	467
SHADE.....	235
TAURUS COLOR ⊕.....	91
TAURUS GRANIT ⊕.....	68
TOUCH.....	245
VALS.....	505
VALS OUTDOOR.....	509



ALBA.....	255
BETONICO.....	278
BLOCK ⊕.....	41
CEMENTO.....	328
COLOR TWO.....	122
COMPILA.....	22
CORE ⊕.....	160
DALE ⊕.....	182
EXTRA.....	360
FLY ⊕.....	198
KAAMOS ⊕.....	58
LIMESTONE.....	390
PIAZZETTA ⊕.....	418
QUARZIT.....	445
REBEL.....	460
TAURUS COLOR ⊕.....	91
TAURUS GRANIT ⊕.....	68



LIMESTONE.....	390
----------------	-----

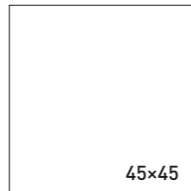

BETONICO.....	278
BLEND.....	292
BLOCK ⊕.....	41
COMPILA.....	22
CONCEPT CONCEPT PLUS.....	334
DECO.....	342
ERA.....	345
EXTRA.....	360
GARDA.....	378
KAAMOS ⊕.....	58
PIAZZETTA ⊕.....	418
REBEL.....	460
SIENA.....	483
TESS.....	489

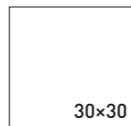

BLOCK ⊕.....	41
COLOR TWO.....	122
COMO.....	331

COMPILA.....	22
CONCEPT CONCEPT PLUS.....	338
DALE.....	182
EXTRA.....	364
FORM.....	373
KAAMOS ⊕.....	58
TAURUS COLOR ⊕.....	91
TAURUS GRANIT ⊕.....	68
TAURUS INDUSTRIAL ⊕.....	84
VIA.....	515



COLOR TWO.....	122
COMPILA.....	35
MANO.....	402



BLOCK ⊕.....	41
COLOR TWO.....	122
CRAFT.....	172
EXTRA.....	364
LINKA.....	396
MIXTONE.....	205
PORFIDO.....	437
QUARZIT.....	448
REBEL.....	463
SALOON.....	479
TAURUS COLOR ⊕.....	91
TAURUS GRANIT ⊕.....	69
TAURUS INDUSTRIAL ⊕.....	84



COLOR TWO.....	122
----------------	-----

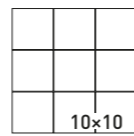

BETONICO.....	284
BLOCK ⊕.....	41
CASTONE.....	319
COLOR TWO.....	123
COMPILA.....	23
CORE ⊕.....	160
DALE ⊕.....	184
EXTRA.....	364
FLY ⊕.....	200
KAAMOS ⊕.....	58
PIAZZETTA ⊕.....	421
QUARZIT.....	448
REBEL.....	463
SHADE.....	235
TAURUS COLOR ⊕.....	91
TAURUS GRANIT ⊕.....	69





Unternehmen Company

Das Unternehmen LASSELSBERGER, s.r.o. ist mit seiner Marke RAKO der einzige Hersteller von Keramikfliesen in der Tschechischen Republik und es gehört zugleich zu den größten Herstellern in Europa. Wir legen Wert auf Harmonie zwischen Funktion und Optik. Die Produktion erfüllt die strengsten Qualitätsstandards, die ISO-Norm 9001, die Anforderungen der Norm EN 14411 und weitere Erklärungen, die Sie für Ihre Projekte benötigen. Wir bieten flexible und zuverlässige Lieferungen weltweit.

LASSELSBERGER, s.r.o., the only producer of RAKO brand ceramic tiles in the Czech Republic, is also one of the leading European producers of ceramic tiling materials. We take pride in the harmony of functionality and aesthetics. We ensure the strictest ISO 9001 quality criteria, EN 14411 requirements and other declarations that your projects need. We are a flexible and reliable supplier worldwide.



Geschichte

History

Unsere Keramikerzeugnisse halten jahrzehntelang, was auch das 140-jährige Bestehen der Marke RAKO auf dem Markt belegt. Unsere Fliesen sind weltweit in vielen modernen sowie historischen Objekten zu sehen. Die erhaltenen Bauwerke mit den RAKO-Originalfliesen aus der Zeit des Jugendstils, Kubismus oder Funktionalismus belegen das Know-how der erfahrenen Fliesenmacher und ihre andauernde Begeisterung für Innovationen und Forschung.

The sustainability of our ceramic products lasts for decades, as evidenced by the 140-year history of the RAKO brand on the market. Our tiles can be found in numerous contemporary and historic buildings around the world. Well-preserved buildings featuring original RAKO tiles from the Art Nouveau, Cubism and Functionalism periods stand as proof of the know-how of the expertise of skilled ceramic makers and their enduring passion for research and innovation.

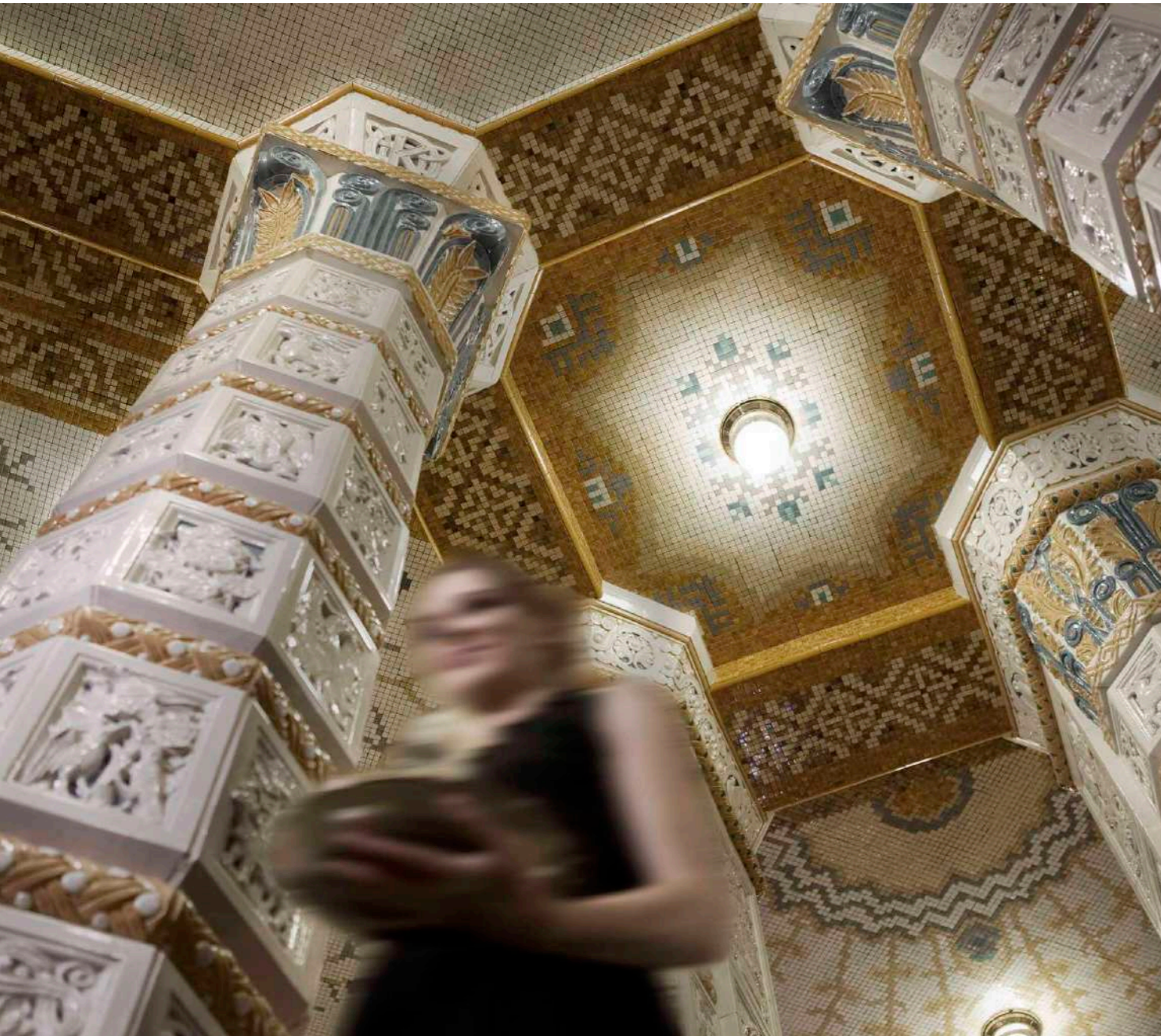

Technologien

Technology

Dank den laufenden Investitionen in Technologien werden in fünf Produktionswerken moderne Kollektionen hergestellt, die die neuesten Designrichtungen widerspiegeln und die Erwartungen der Architekten und Endkunden erfüllen. Allein in den vergangenen zehn Jahren wurden rund 180 Millionen Euro in die modernsten Technologien und den Umweltschutz investiert.

Through continuous investment in technology across five production plants, we create modern collections that reflect current design trends and meet the expectations of both architects and end users. Over the past ten years we have invested about EUR 180 million in cutting-edge technologies and environmental protection.

Service Services

Durch das breitgefächerte Sortiment ist die Marke RAKO auf allen Kontinenten vertreten. Wir beliefern über 90 Länder der Welt. RAKO ist ein globaler Spezialist sowohl im Designbereich als auch bei den Technologien für jede Keramikoberfläche. Dadurch kann den Kunden immer die beste Lösung für die jeweilige Anwendung angeboten werden, einschließlich Systemlösungen und Support durch erfahrene Projektfachleute.

Thanks to its comprehensive product range, the RAKO brand is represented on all continents and exported to more than 90 countries throughout the world. RAKO is a global specialist in both design and technology in any type of ceramic surface, which allows us to always offer our clients the best solution for each application. Including system solutions and support by experienced project specialists.



Umweltschutz Ecology

Das Unternehmen verarbeitet mehr als 96 % eigener Rohstoffe. Wir achten auf nachhaltige Produktion, Materialrückgewinnung und effektiven Umgang mit allen Ressourcen. Die RAKO-Verpackungen sind wiederverwertbar. Aus den Keramikfliesen werden keine toxischen Schadstoffe freigesetzt und sind daher gesundheitlich unbedenklich. Das Unternehmen verfügt über folgende Zertifikate: LEED und BREEAM, ISO 14025 und EN 15804, ISO 50001 u. a.

We process more than 96 % of our own raw material. We prioritize ecological production, innovate our materials, and manage all resources effectively. RAKO packaging is recyclable and our ceramic tiles do not release toxic harmful chemicals into the environment, ensuring they are safe for health. We hold the following certifications: LEED and BREEAM, ISO 14025 and EN 15804, ISO 50001, among others.



LAVAZZA

Sail-on

Object





Eine einzigartige Kollektion mit zwölf brandneuen Farben in einer breiten Palette von Formaten für Wand- und Bodenfliesen. Das neutrale und einheitliche Design aus weichem Granit bietet unendliche Möglichkeiten innerhalb der COMPILA-Serie und in Kombination mit anderen RAKO-Serien, um jeden öffentlichen oder privaten Raum zu gestalten.

Es kann so originell sein wie Sie selbst!

„Perfekte Kompilation von Formaten, Farben und Dekorationen.“



A unique collection of twelve brand new colors in wide range of formats in both wall and floor tiles. Neutral and uniform soft granite design offers never-ending possibilities within COMPILA series, or by combining with other RAKO series, to transform any public or residential space.

It can be as original as you are!

„The ultimate compilation of colors, formats and decorations.“





The art of compilations

Compila für Ihre Inspiration...

Jede Fliese der Compila ist so konzipiert, dass es sowohl ästhetischen als auch technischen Ansprüchen entspricht.

Die einzelnen Ambiente auf den folgenden Seiten zeigen, wie einfach es ist, verschiedene Fliesen der Compila-Serie miteinander und mit anderen Produkten aus dem RAKO-Sortiment zu kombinieren. Die Serie Compila zeichnet sich durch ihre Vielseitigkeit, Originalität und Fantasie aus, die sich in der Auswahl an Farben, Formaten und Oberflächen widerspiegelt.

In den einzelnen Abbildungen werden die Fliesen mit verschiedenen Oberfläche von glänzend bis matt präsentiert. Zum besseren Verständnis werden diese Unterschiede mit Kugelmodellen dargestellt. Für das vertikal ausgerichtete Regal werden Elemente für die Wand, während die horizontal Darstellung die Bodenfliesen präsentiert.



Compilation for Your Inspiration...

The Compila series is designed to meet both aesthetics and technical requirements.

The following pages showcase individual product compositions, illustrating the possible combinations of different elements from the Compila series as well as other products within the RAKO range.

Defined by its versatility, originality and creativity, the series presents a diverse range of colors, formats, and surfaces. From high gloss to full matt, each product is presented with a specific surface type, clarified through sphere models for better visualization.

The vertically oriented shelf displays elements designed for walls, while the horizontally positioned partitions represent floor tile products. These visualizations provide a clear understanding of the final look that can be achieved once the selected products are installed in a space.



Handwritten notes:
Compilation 001
Floor:
 - COMPILA COTTO 60x60
 - PLYWOOD HONEY 60x120
WALL:
 - COMPILA PAPER 30x60
 - COMPILA MINT 30x60
 - COMPILA MINT 10x30



10x30
compila
mini



30x90
blossom
rich



20x60
majolika
white



30x60
compila
cement



60x60
compila
ornamento

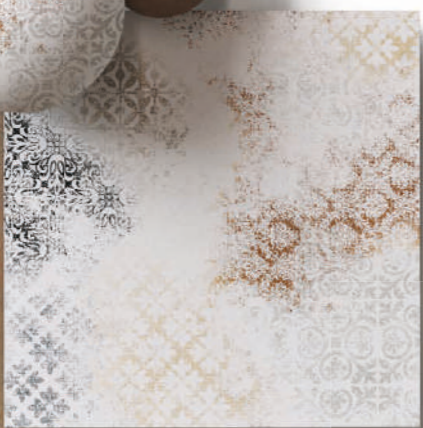

60x120
craft
pottery

10x30
compila
aqua



10x30
compila
storm



30x60
compila
herbs



30x60
compila
aqua



30x60
compila
paper



60x120
fly
mist

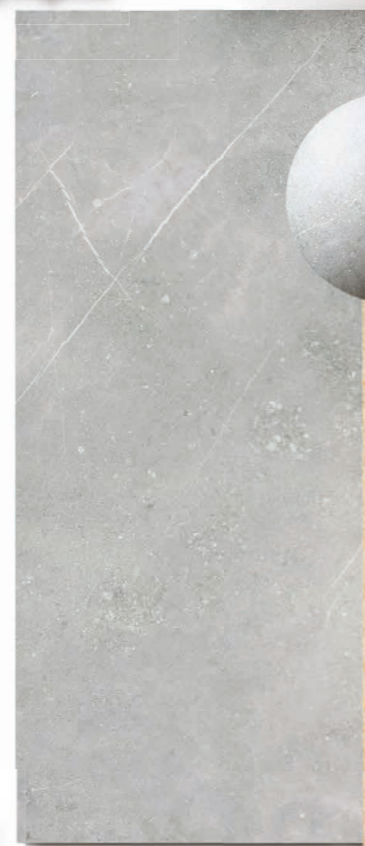

60x60
compila
storm



20x120
pino
bloom





Produkt product								
EN 14411 - G Bla STO Nr. 030 - 059824	Bodenfliese floor tile	Bodenfliese floor tile	Bodenfliese floor tile	Bodenfliese floor tile	Bodenfliese floor tile	Bodenfliese floor tile	Bodenfliese floor tile	Bodenfliese floor tile
	120x120 R News	60x120 R	60x60 R	30x60 R	45x45	30x30		
	1198x1198x8,5	598x1198x10* 598x1198x9**	598x598x9	298x598x9	448x448x8	298x298x8		
Oberfläche surface	ABS	ABS	ABS		matt	ABS		ABS
Rutschfestigkeit slip resistance	R10/B	R10/B	R10/B		R11/B	R10/B		R10/B
Reibungskoeffizient - trocken sliding friction coefficient - dry	$\mu \geq 0,6$	$\mu \geq 0,6$	$\mu \geq 0,6$		$\mu \geq 0,6$	$\mu \geq 0,6$		$\mu \geq 0,6$
Farbe color								
Shadow dunkelgrau dark grey	DAK92866 ○ 900 m ²	DAKV1866* DAKV9866** ○ 700 m ²	DAK62866 ○ 560 m ²	DAF62866 ○ 640 m ²	DAKSR866 ○ 540 m ²	DAFSR866 ○ 620 m ²	DAA4H866 ○ 510 m ²	DAA34866 ○ 390 m ²
Taupe grau-beige grey-beige	DAK92867 ○ 900 m ²	DAKV1867* DAKV9867** ○ 700 m ²	DAK62867 ○ 560 m ²	DAF62867 ○ 640 m ²	DAKSR867 ○ 540 m ²	DAFSR867 ○ 620 m ²	DAA4H867 ○ 510 m ²	DAA34867 ○ 390 m ²
Paper weiß-grau white-grey	DAK92864 ○ 900 m ²	DAKV1864* DAKV9864** ○ 700 m ²	DAK62864 ○ 560 m ²	DAKSR864 ○ 540 m ²			DAA4H864 ○ 510 m ²	DAA34864 ○ 390 m ²
Cement grau grey	DAK92865 ○ 900 m ²	DAKV1865* DAKV9865** ○ 700 m ²	DAK62865 ○ 560 m ²	DAF62865 ○ 640 m ²	DAKSR865 ○ 540 m ²	DAFSR865 ○ 620 m ²	DAA4H865 ○ 510 m ²	DAA34865 ○ 390 m ²
Storm schwarz-blau black-blue		DAKV1870* DAKV9870** ○ 700 m ²	DAK62870 ○ 560 m ²		DAKSR870 ○ 540 m ²		DAA4H870 ○ 510 m ²	DAA34870 ○ 390 m ²
Cotto braun-rot brown-red		DAKV1869* DAKV9869** ○ 700 m ²	DAK62869 ○ 560 m ²		DAKSR869 ○ 540 m ²		DAA4H869 ○ 510 m ²	DAA34869 ○ 390 m ²
Sand ocker ochre		DAKV1868* DAKV9868** ○ 700 m ²	DAK62868 ○ 560 m ²		DAKSR868 ○ 540 m ²		DAA4H868 ○ 510 m ²	DAA34868 ○ 390 m ²
Coal braun-schwarz brown-black		DAKV1871* DAKV9871** ○ 700 m ²	DAK62871 ○ 560 m ²		DAKSR871 ○ 540 m ²		DAA4H871 ○ 510 m ²	DAA34871 ○ 390 m ²
logistische Daten logistic information								
	2	2 2	4		7		6	13
	0,7	1,4 1,4	2,8		5,6		5	11
	2,88	1,44 1,44	1,44		1,26		1,21	1,18
	24	27 30	32		40		34	48
	69,12	38,88 43,20	46,08		50,40		41,14	56,64
	53,1	32,7 30,0	27,6		24,2		21,1	20,5
	18,9	22,7 20,9	19,2		19,2		17,4	17,4
	1 330	908 924	910		993		741	1 011

* Verfügbar solange der Vorrat reicht | Available while stocks last

** Neues Produkt in 9 mm Stärke im Laufe des Jahres 2025 verfügbar | New product in 9 mm thickness available during 2025

Bodenfliese floor tile	Mosaik sheet 30x30 cm mosaic sheet 30x30cm	Stufe step tile	Stufe step tile	Stufenformteil special step tile	Socket skirting plinth	Socket skirting plinth	Socket skirting plinth	Socket skirting plinth	Hohlkeh- socket cove skirting
10x10 R	5x5 R	30x120 R	30x60 R	30x120 R	120x7,2 R News	60x7,2 R	45x8,5	30x7,2	30x11 News
98x98x9	48x48x9	298x1198x10* 298x1198x9**	298x598x9	298x1198x10* 298x1198x9**	1198x72x9	598x72x9	448x85x8	298x72x8	298x110x8
ABS	ABS	ABS	ABS	ABS	ABS	ABS	ABS	ABS	ABS
R10/B	R10/B	R10/B	R10/B	R10/B					
$\mu \geq 0,6$	$\mu \geq 0,6$	$\mu \geq 0,6$	$\mu \geq 0,6$	$\mu \geq 0,6$					
DAK11866 ○ 900 m ²	DDM05866 ○ 300 Netz	DCPVF866* DCPVD866** ○ 740 St	DCPSR866 ○ 270 St	DCFVF866* DCFVD866** ○ 1300 St	DSA99866 ○ 380 St	DSAS3866 ○ 180 St	DSAPS866 ○ 160 St	DSAJ8866 ○ 110 St	DSPJT866 ○ 200 St
DAK11867 ○ 900 m ²	DDM05867 ○ 300 Netz	DCPVF867* DCPVD867** ○ 740 St	DCPSR867 ○ 270 St	DCFVF867* DCFVD867** ○ 1300 St	DSA99867 ○ 380 St	DSAS3867 ○ 180 St	DSAPS867 ○ 160 St	DSAJ8867 ○ 110 St	DSPJT867 ○ 200 St
DAK11864 ○ 900 m ²	DDM05864 ○ 300 Netz	DCPVF864* DCPVD864** ○ 740 St	DCPSR864 ○ 270 St	DCFVF864* DCFVD864** ○ 1300 St	DSA99864 ○ 380 St	DSAS3864 ○ 180 St	DSAPS864 ○ 160 St	DSAJ8864 ○ 110 St	DSPJT864 ○ 200 St
DAK11865 ○ 900 m ²	DDM05865 ○ 300 Netz	DCPVF865* DCPVD865** ○ 740 St	DCPSR865 ○ 270 St	DCFVF865* DCFVD865** ○ 1300 St	DSA99865 ○ 380 St	DSAS3865 ○ 180 St	DSAPS865 ○ 160 St	DSAJ8865 ○ 110 St	DSPJT865 ○ 200 St
DAK11870 ○ 900 m ²	DDM05870 ○ 300 Netz	DCPVF870* DCPVD870** ○ 740 St	DCPSR870 ○ 270 St	DCFVF870* DCFVD870** ○ 1300 St		DSAS3870 ○ 180 St	DSAPS870 ○ 160 St	DSAJ8870 ○ 110 St	DSPJT870 ○ 200 St
DAK11869 ○ 900 m ²	DDM05869 ○ 300 Netz	DCPVF869* DCPVD869** ○ 740 St	DCPSR869 ○ 270 St	DCFVF869* DCFVD869** ○ 1300 St		DSAS3869 ○ 180 St	DSAPS869 ○ 160 St	DSAJ8869 ○ 110 St	DSPJT869 ○ 200 St
DAK11868 ○ 900 m ²	DDM05868 ○ 300 Netz	DCPVF868* DCPVD868** ○ 740 St	DCPSR868 ○ 270 St	DCFVF868* DCFVD868** ○ 1300 St		DSAS3868 ○ 180 St	DSAPS868 ○ 160 St	DSAJ8868 ○ 110 St	DSPJT868 ○ 200 St
DAK11871 ○ 900 m ²	DDM05871 ○ 300 Netz	DCPVF871* DCPVD871** ○ 740 St	DCPSR871 ○ 270 St	DCFVF871* DCFVD871** ○ 1300 St		DSAS3871 ○ 180 St	DSAPS871 ○ 160 St	DSAJ8871 ○ 110 St	DSPJT871 ○ 200 St
11	3	3 3	5	2 2	11	14	25	30	35
11	11	2,8 2,8	5,6	-	11,9	23,1	26,1	46,3	30
1,00	0,27	1,08 1,08	0,90	-	0,93	0,60	0,96	0,65	1,17
56	-	-	-	-	-	-	-	-	-
56,00	-	-	-	-	-	-	-	-	-
19,2	5,2	24,6 22,5	17,3	20,5	20,4	11,5	16,7	11,3	19,3
19,2	19,2	-	19,2	-	-	19,2	17,4	17,4	16,5
1 125	-	-	-	-	-	-	-	-	-

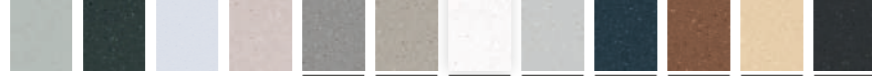

Farben | colors



Dxxxx866 PEI 4
Shadow
dunkelgrau | dark grey



Dxxxx867 PEI 4
Taupe
grau-beige | grey-beige



Dxxxx864 PEI 5
Paper
weiß-grau | white-grey



Dxxxx865 PEI 5
Cement
grau | grey



Dxxxx870 PEI 4
Storm
schwarz-blau | black-blue



Dxxxx869 PEI 4
Cotto
braun-rot | brown-red

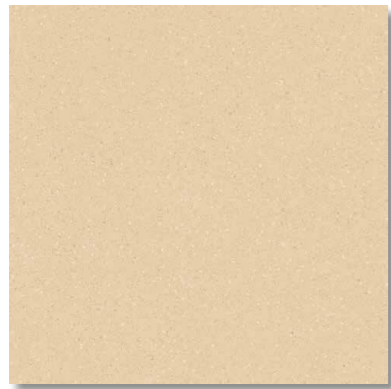

Dxxxx868 PEI 4
Sand
ocker | ochre

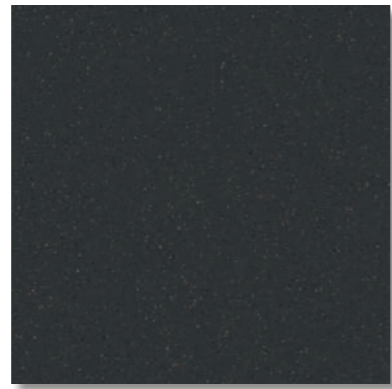

Dxxxx871 PEI 4
Coal
braun-schwarz | brown-black



Oberflächen | surfaces



ABS R10/B
 $\mu \geq 0,6$



R11/B
 $\mu \geq 0,6$



Formteile | special pieces

Stufe | step tile | DCPVF... | 298x1198x10 mm*

DCPVD... | 298x1198x9 mm**

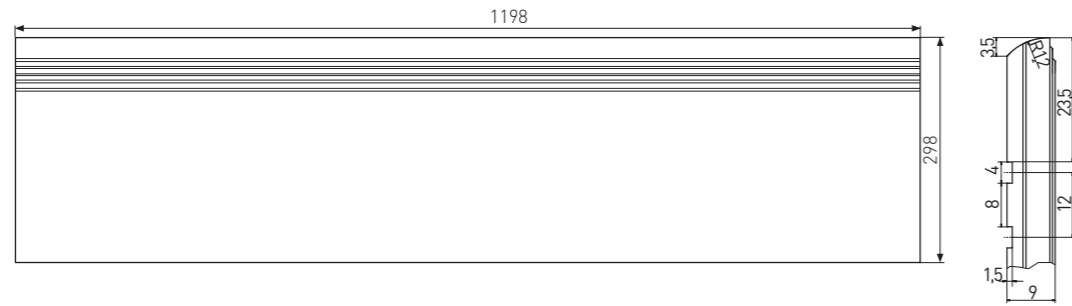

Stufe | step tile | DCPSR... | 298x598x9 mm

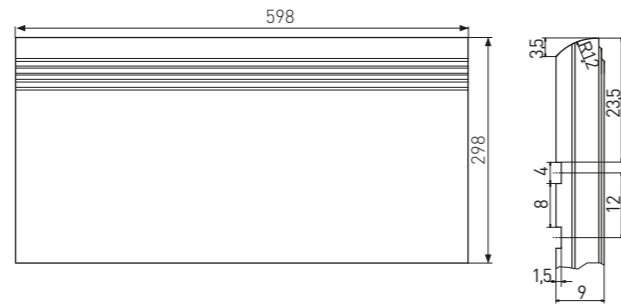
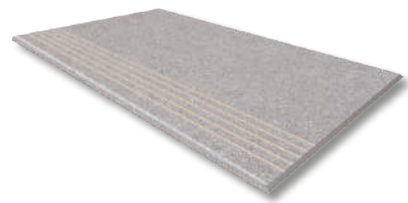

Stufenformteil | special step tile | DCFVF... | 298x1198x10 mm*

DCFVD... | 298x1198x9 mm**

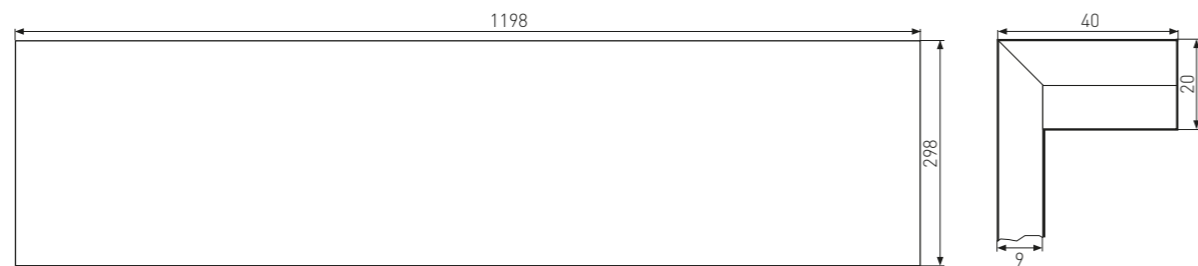

Socket | skirting plinth | DSA99... | 1198x72x9 mm **News**

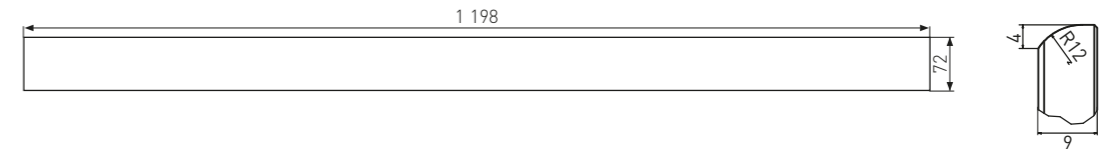

Socket | skirting plinth | DSAS3... | 598x72x9 mm

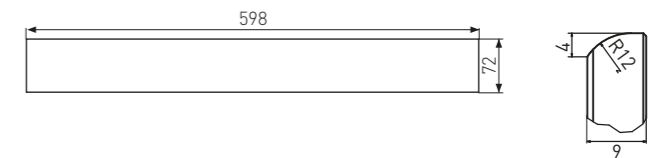

Socket | skirting plinth | DSAPS... | 448x85x8 mm

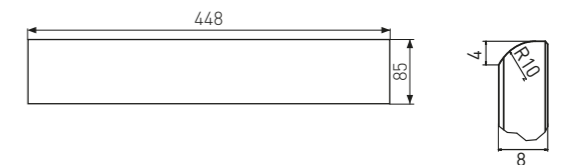

Socket | skirting plinth | DSAJ8... | 298x72x8 mm

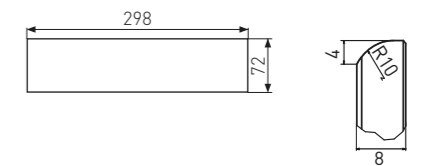

Hohlkehlssocket | cove skirting | DSPJT... | 298x110x8 mm **News**

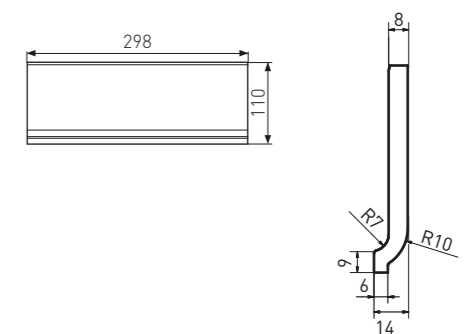











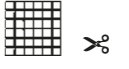



* Verfügbar solange der Vorrat reicht | Available while stocks last

** Neues Produkt in 9 mm Stärke im Laufe des Jahres 2025 verfügbar | New product in 9 mm thickness available during 2025





Produkt product				
EN 14411 - L BIII	Wandfliese wall tile	Wandfliese wall tile	Wandfliese wall tile	Mosaik sheet 30x30 cm mosaic sheet 30x30cm
	30x60 	30x60	20x40	5x5 
	298x598x8	298x598x8	198x398x7	48x48x7
Oberfläche surface	matt	matt	matt	matt
Farbe color				
Mint hellgrün light green	WAKVK862 ○ 500 m ²	WADVK862 ○ 480 m ²	WADMB862 ○ 400 m ²	WDM05862 ○ 250 Netz
Botanic dunkelgrün dark green	WAKVK863 ○ 500 m ²	WADVK863 ○ 480 m ²	WADMB863 ○ 400 m ²	WDM05863 ○ 250 Netz
Aqua hellblau light blue	WAKVK861 ○ 500 m ²	WADVK861 ○ 480 m ²	WADMB861 ○ 400 m ²	WDM05861 ○ 250 Netz
Nude hellrosa light pink	WAKVK860 ○ 500 m ²	WADVK860 ○ 480 m ²	WADMB860 ○ 400 m ²	WDM05860 ○ 250 Netz
Shadow dunkelgrau dark grey	WAKVK866 ○ 500 m ²	WADVK866 ○ 480 m ²	WADMB866 ○ 400 m ²	WDM05866 ○ 250 Netz
Taupe grau-beige grey-beige	WAKVK867 ○ 500 m ²	WADVK867 ○ 480 m ²	WADMB867 ○ 400 m ²	WDM05867 ○ 250 Netz
Paper weiß-grau white-grey	WAKVK864 ○ 500 m ²	WADVK864 ○ 480 m ²	WADMB864 ○ 400 m ²	WDM05864 ○ 250 Netz
Cement grau grey	WAKVK865 ○ 500 m ²	WADVK865 ○ 480 m ²	WADMB865 ○ 400 m ²	WDM05865 ○ 250 Netz
logistische Daten logistic information				
	8	20	4	
	5,56	12,5	11	
	1,44	1,60	0,36	
	40	48	-	
	57,60	76,80	-	
	21,3	20,6	4,8	
	14,8	12,9	12,9	
	876	1 016	-	



Farben | colors

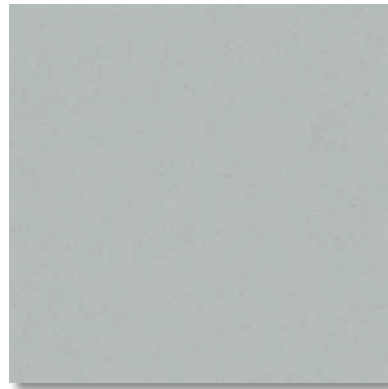

Wxxxx862
Mint
hellgrün | light green



Wxxxx863
Botanic
dunkelgrün | dark green

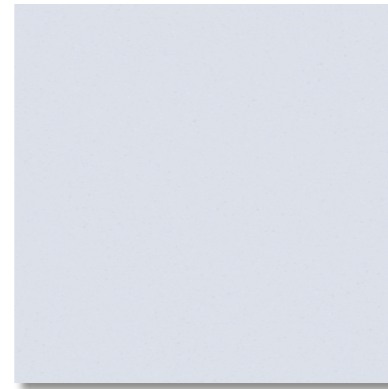

Wxxxx861
Aqua
hellblau | light blue



Wxxxx860
Nude
hellrosa | light pink

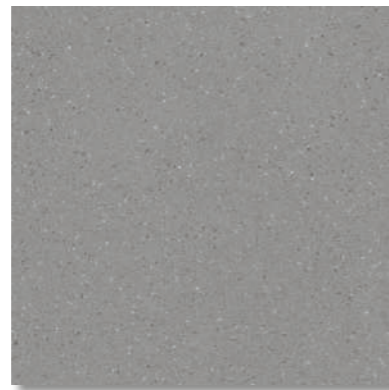

Wxxxx866
Shadow
dunkelgrau | dark grey



Wxxxx867
Taupe
grau-beige | grey-beige

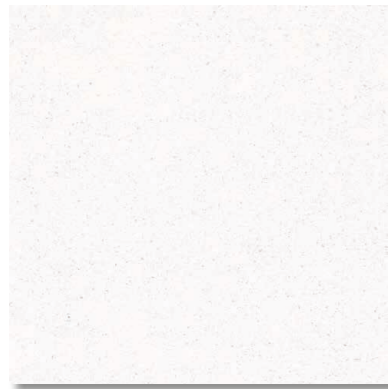

Wxxxx864
Paper
weiß-grau | white-grey



Wxxxx865
Cement
grau | grey



Oberflächen | surfaces



matt

Dekore | decoration



Dekor | decor | 98x298x8 mm



GARJD862
 ○ 670 l m²
 relief glossy
 color **mint**
 hellgrün | light green



GARJD863
 ○ 670 l m²
 relief glossy
 color **botanic**
 dunkelgrün | dark green



GARJD861
 ○ 670 l m²
 relief glossy
 color **aqua**
 hellblau | light blue



GARJD860
 ○ 670 l m²
 relief glossy
 color **nude**
 hellrosa | light pink



GARJD867
 ○ 670 l m²
 relief glossy
 color **taupe**
 grau-beige | grey-beige



GARJD864
 ○ 670 l m²
 relief glossy
 color **paper**
 weiß-grau | white-grey



GARJD865
 ○ 670 l m²
 relief glossy
 color **cement**
 grau | grey



GARJD870
 ○ 670 l m²
 relief glossy
 color **storm**
 schwarz-blau | black-blue



GARJD869
 ○ 670 l m²
 relief glossy
 color **cotto**
 braun-rot | brown-red



Dekor | decor | **Ornamento** | 598x598x9 mm



DAK62872
 ○ 560 l m²
 matt |



Produkt | product



Bodenfliese floor tile	10x30	98x298x8	EN 14411 - H Blb	24	33,3	0,72	66	47,52	12,5	17,3	851
Bodenfliese floor tile	60x60	598x598x9	EN 14411 - G Bla	4	2,8	1,44	32	46,08	27,6	19,2	910

Die Produktverpackung enthält zufällige Designmöglichkeiten. | The products are deliberately mixed in packing to include a random selection of designs. Empfohlene Formatkombinationen 10x30 siehe Seite 522-523. | Recommended combinations of modular sizes 10x30 see pages 522-523.



Dekore | decoration

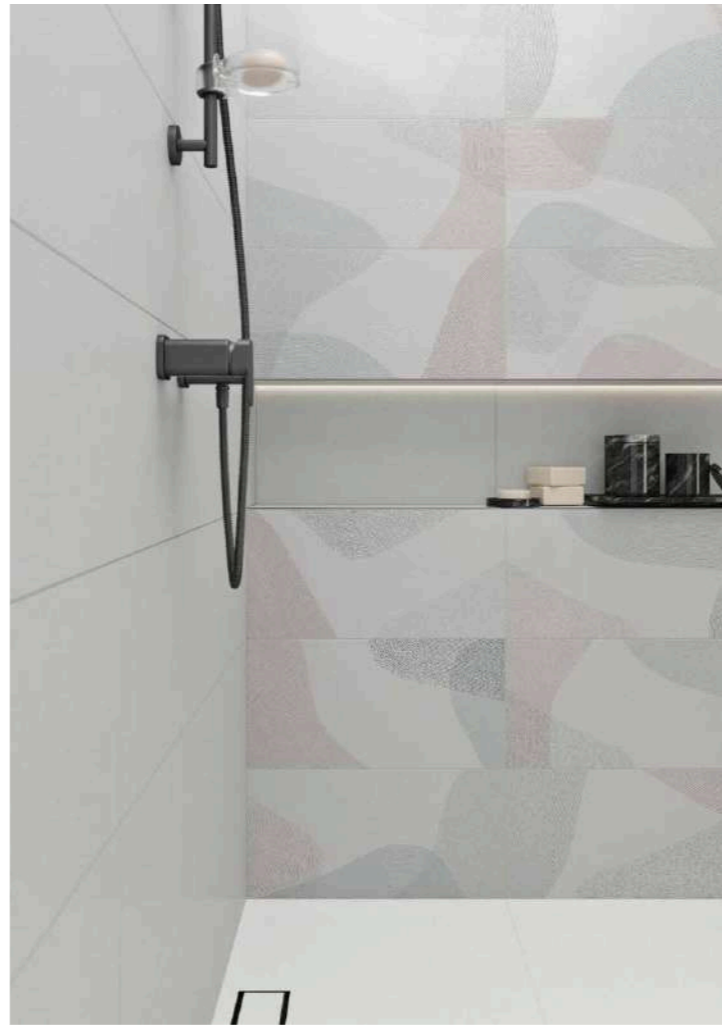

Dekor | decor | **Ornamento** | 298x598x8 mm



WAKVK871
 ○ 500 | m²
 matt | **v4** |



News

Dekor | decor | **Game** | 298x598x8 mm



WADVK872
 ○ 480 | m²
 matt | **v3** |



30x60

Dekor | decor | **Onsen** | 298x598x8 mm



WAKVK873
 ○ 500 | m²
 matt | **v3** |



Dekor | decor | **Herbs** | 298x598x8 mm



WIKVK141
 ○ 920 | set
 matt |

WIDVK141
 ○ 920 | set
 matt

(SET)

Produkt | product



Dekor 1 set/4 St | decor 1 set/4 pcs
 Wandfliese | wall tile

30x60

30x60

298x598-8

298x598-8

EN 14411 - L BIII

4

5,56

0,72

-

-

10,7

14,8

-



Die Serie BLOCK ist die perfekte Kombination aus zeitloser Granitoptik und kompromissloser Qualität. Durch das umfangreiche Angebot an Formaten unglasierter Feinsteinzeug-Bodenfliesen, ihre Oberflächenvielfalt und ihre Rutschfestigkeit (R10/B) eignet sich die Serie BLOCK für den universellen Einsatz im Innen- und Außenbereich öffentlicher und privater Gebäude.

„Im Stil moderner Architektur.“



The BLOCK series is the perfect combination of timeless granite design and uncompromising quality. The wide format range of sintered unglazed tiles, surface variety, and anti-slip properties (R10/B) make the BLOCK series suitable for the unlimited use in the interior and exterior of both public and private buildings.

„The style of modern architecture.“





Produkt product					
EN 14411 - G B1a	Bodenfliese floor tile	Bodenfliese floor tile	Bodenfliese floor tile	Bodenfliese floor tile	
	60×120 R	80×80 R	40×80 R	60×60 R	
	598×1198×10* 598×1198×9**	798×798×10	398×798×10	598×598×10* 598×598×9**	
Oberfläche surface	ABS	ABS	ABS	ABS	lappato
Rutschfestigkeit slip resistance	R10/B	R10/B	R10/B	R10/B	R9
Reibungskoeffizient - trocken sliding friction coefficient - dry	μ ≥ 0,6	μ ≥ 0,6	μ ≥ 0,6	μ ≥ 0,6	μ ≥ 0,5
Farbe color					
schwarz black	DAKV1783* DAKV9783** ○ 700 m ²	DAK81783 ○ 700 m ²	DAK84783 ○ 720 m ²	DAK63783* DAK62783** ○ 560 m ²	DAP63783* DAP62783** ○ 610 m ²
dunkelgrau dark grey	DAKV1782* DAKV9782** ○ 700 m ²	DAK81782 ○ 700 m ²	DAK84782 ○ 720 m ²	DAK63782* DAK62782** ○ 560 m ²	DAP63782* DAP62782** ○ 610 m ²
grau grey	DAKV1781* DAKV9781** ○ 700 m ²	DAK81781 ○ 700 m ²	DAK84781 ○ 720 m ²	DAK63781* DAK62781** ○ 560 m ²	DAP63781* DAP62781** ○ 610 m ²
hellgrau light grey	DAKV1780* DAKV9780** ○ 700 m ²	DAK81780 ○ 700 m ²	DAK84780 ○ 720 m ²	DAK63780* DAK62780** ○ 560 m ²	DAP63780* DAP62780** ○ 610 m ²
beige beige	DAKV1784* DAKV9784** ○ 700 m ²	DAK81784 ○ 700 m ²	DAK84784 ○ 720 m ²	DAK63784* DAK62784** ○ 560 m ²	DAP63784* DAP62784** ○ 610 m ²
logistische Daten logistic information					
	2 2	2	4	3 4	
	1,4 1,4	1,6	3,1	2,8 2,8	
	1,44 4,4	1,28	1,28	1,08 1,44	
	27 30	42	42	32 32	
	38,88 43,20	53,76	53,76	34,56 46,08	
	32,7 30,0	28,0	28,0	23,7 29,1	
	22,7 20,9	21,9	21,9	21,9 20,2	
	908 924	1 202	1 202	782 955	

* Verfügbar solange der Vorrat reicht | Available while stocks last

** Neues Produkt in 9 mm Stärke im Laufe des Jahres 2025 verfügbar | New product in 9 mm thickness available during 2025

Bodenfliese floor tile	Bodenfliese floor tile	Bodenfliese floor tile	Bodenfliese floor tile	Bodenfliese floor tile mosaic sheet 30×30 cm	Mosaik sheet 30×30 cm mosaic sheet 30×30 cm
30×60 R	45×45	30×30	20×20 R	10×10 R	5×5 R
298×598×10* 298×598×9**	448×448×8	298×298×8	198×198×10* 197×197×9**	98×98×10* 98×98×9**	48×48×10* 48×48×9**
ABS	lappato	ABS	ABS	ABS	matt/lappato
R10/B	R9	R10/B	R10/B	R10/B	R10/B
μ ≥ 0,6	μ ≥ 0,5	μ ≥ 0,6	μ ≥ 0,6	μ ≥ 0,6	μ ≥ 0,6
DAKSE783* DAKSR783** ○ 540 m ²	DAPSE783* DAPSR783** ○ 600 m ²	DAA4H783 ○ 510 m ²	DAA34783 ○ 390 m ²	DAK26783* DAK25783** ○ 780 m ²	DAK12783* DAK11783** ○ 900 m ²
DDM06783* DDM05783** ○ 300 Netz					
DAKSE782* DAKSR782** ○ 540 m ²	DAPSE782* DAPSR782** ○ 600 m ²	DAA4H782 ○ 510 m ²	DAA34782 ○ 390 m ²	DAK26782* DAK25782** ○ 780 m ²	DAK12782* DAK11782** ○ 900 m ²
DDM06782* DDM05782** ○ 300 Netz					
DAKSE781* DAKSR781** ○ 540 m ²	DAPSE781* DAPSR781** ○ 600 m ²	DAA4H781 ○ 510 m ²	DAA34781 ○ 390 m ²	DAK26781* DAK25781** ○ 780 m ²	DAK12781* DAK11781** ○ 900 m ²
DDM06781* DDM05781** ○ 300 Netz					
DAKSE780* DAKSR780** ○ 540 m ²	DAPSE780* DAPSR780** ○ 600 m ²	DAA4H780 ○ 510 m ²	DAA34780 ○ 390 m ²	DAK26780* DAK25780** ○ 780 m ²	DAK12780* DAK11780** ○ 900 m ²
DDM06780* DDM05780** ○ 300 Netz					
DAKSE784* DAKSR784** ○ 540 m ²	DAPSE784* DAPSR784** ○ 600 m ²	DAA4H784 ○ 510 m ²	DAA34784 ○ 390 m ²	DAK26784* DAK25784** ○ 780 m ²	DAK12784* DAK11784** ○ 900 m ²
DDM06784* DDM05784** ○ 300 Netz					
6 7	6	13	23 25	10 11	3 3
5,6 5,6	5	11	25 25	11 11	11 11
1,08 1,26	1,21	1,18	0,92 1,00	0,91 1,00	0,27 0,27
40 40	34	48	57 57	56 56	-
43,2 50,40	41,14	56,64	52,44 57,00	50,96 56,00	-
23,7 24,2	21,1	20,5	20,1 19,2	19,9 19,2	5,9 5,2
21,9 19,2	17,4	17,4	21,9 19,2	21,9 19,2	-
971 993	741	1 011	1 174 1119	1 142 1125	-

Produkt product					
EN 14411 - G Bia STO No. 030 - 059824	Stufe step tile	Stufe step tile	Stufe step tile	Stufenformteil special step tile	Stufenformteil special step tile
	30×120 R	40×80 R	30×60 R	30×120 R	40×80 R
	298×1198×10* 298×1198×9**	398×798×10	298×598×10* 298×598×9**	298×1198×10* 298×1198×9**	398×798×10
Oberfläche surface	ABS	ABS	ABS	ABS	ABS
Rutschfestigkeit slip resistance	R10/B	R10/B	R10/B	R10/B	R10/B
Reibungskoeffizient - trocken sliding friction coefficient - dry	μ ≥ 0,6	μ ≥ 0,6	μ ≥ 0,6	μ ≥ 0,6	μ ≥ 0,6
Farbe color					
schwarz black	DCPVF783* DCPVD783** ○ 740 St	DCP84783 ○ 380 St	DCPSE783* DCPSR783** ○ 270 St	DCFVF783* DCFVD783** ○ 1300 St	DCF84783 ○ 1130 St
dunkelgrau dark grey	DCPVF782* DCPVD782** ○ 740 St	DCP84782 ○ 380 St	DCPSE782* DCPSR782** ○ 270 St	DCFVF782* DCFVD782** ○ 1300 St	DCF84782 ○ 1130 St
grau grey	DCPVF781* DCPVD781** ○ 740 St	DCP84781 ○ 380 St	DCPSE781* DCPSR781** ○ 270 St	DCFVF781* DCFVD781** ○ 1300 St	DCF84781 ○ 1130 St
hellgrau light grey	DCPVF780* DCPVD780** ○ 740 St	DCP84780 ○ 380 St	DCPSE780* DCPSR780** ○ 270 St	DCFVF780* DCFVD780** ○ 1300 St	DCF84780 ○ 1130 St
beige beige	DCPVF784* DCPVD784** ○ 740 St	DCP84784 ○ 380 St	DCPSE784* DCPSR784** ○ 270 St	DCFVF784* DCFVD784** ○ 1300 St	DCF84784 ○ 1130 St
logistische Daten logistic information					
	3/5 3	2	6 5	2 2	2
	2,8 2,8	3,1	5,6 5,6	-	-
	1,08/1,80 1,08	0,64	1,08 0,90	-	-
	-	-	-	-	-
	-	-	-	-	-
	24,6/40,9 22,5	14,1	23,7 17,3	-	16,5
	-	21,9	-	-	-
	-	-	-	-	-

Socket skirting plinth	Socket skirting plinth	Socket skirting plinth	Socket skirting plinth
80×9,5 R	60×9,5* 60×7,2** R		45×8,5
798×95×10	598×95×10* 598×72×9**		448×85×8
ABS	ABS	lappato	ABS
DSA89783 ○ 210 St	DSAS4783* DSAS3783** ○ 180 St	DSKS4783* DSKS3783** ○ 270 St	DSAPS783 ○ 160 St
DSA89782 ○ 210 St	DSAS4782* DSAS3782** ○ 180 St	DSKS4782* DSKS3782** ○ 270 St	DSAPS782 ○ 160 St
DSA89781 ○ 210 St	DSAS4781* DSAS3781** ○ 180 St	DSKS4781* DSKS3781** ○ 270 St	DSAPS781 ○ 160 St
DSA89780 ○ 210 St	DSAS4780* DSAS3780** ○ 180 St	DSKS4780* DSKS3780** ○ 270 St	DSAPS780 ○ 160 St
DSA89784 ○ 210 St	DSAS4784* DSAS3784** ○ 180 St	DSKS4784* DSKS3784** ○ 270 St	DSAPS784 ○ 160 St
10	13 14		25
13,2	17,5 23,1		26,1
0,76	0,74 0,60		0,96
-	-		-
-	-		-
16,7	16,2 11,5		16,7
21,9	-		17,4
-	-		-

* Verfügbar solange der Vorrat reicht | Available while stocks last

** Neues Produkt in 9 mm Stärke im Laufe des Jahres 2025 verfügbar | New product in 9 mm thickness available during 2025

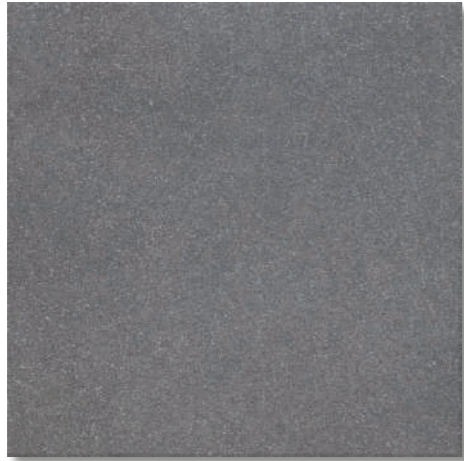

Dxxxx783
schwarz | black



Dxxxx782
dunkelgrau | dark grey



Dxxxx781
grau | grey



Dxxxx780
hellgrau | light grey



Dxxxx784
beige | beige

Die Farbnuancen, die hier abgebildet sind, haben nur den Orientierungscharakter. | The colour shades shown are for orientation only.



ABS
R10/B
μ > 0,6



lappato
R9
μ > 0,5

ABS... - Rutschhemmende Oberfläche R10/B | Slip-resistant surface R10/B

Formteile | special pieces

Stufe | step tile | DCPVF... | 298×1198×10 mm*

DCPVD... | 298×1198×9 mm**

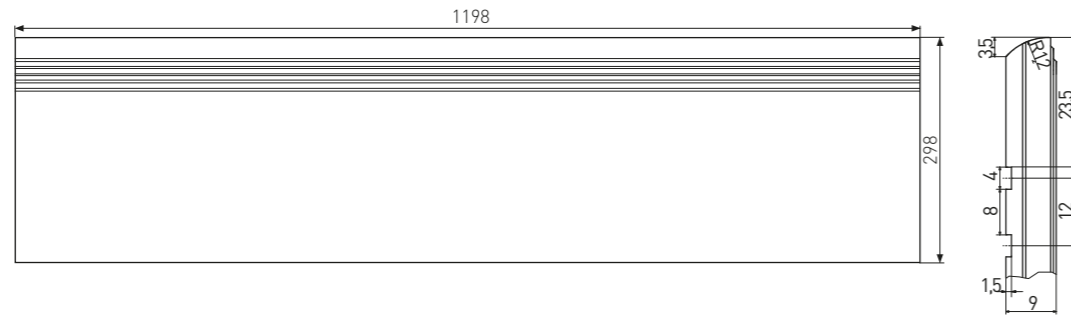

Stufe | step tile | DCP84... | 398×798×10 mm

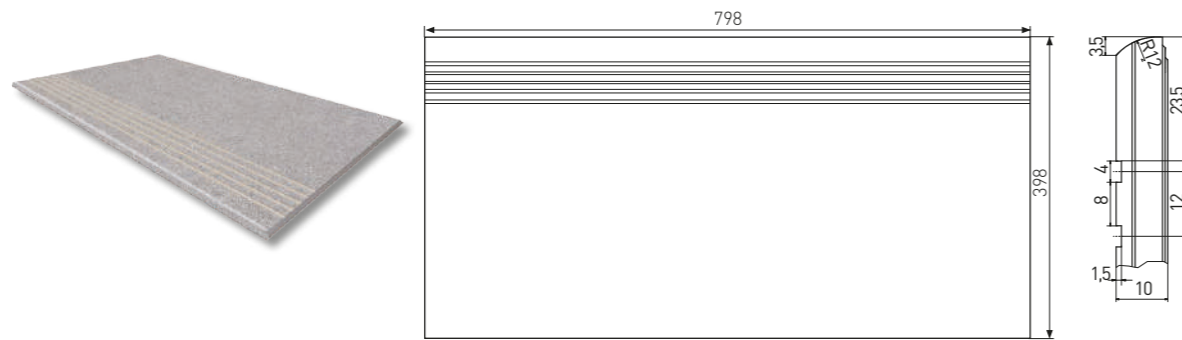

Stufe | step tile | DCPSE... | 298×598×10 mm*

DCPSR... | 298×598×9 mm**

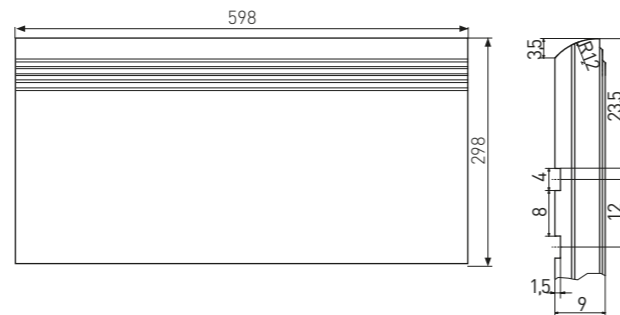

Stufenformteil | special step tile | DCFVF... | 298×1198×10 mm*

DCFVD... | 298×1198×9 mm**

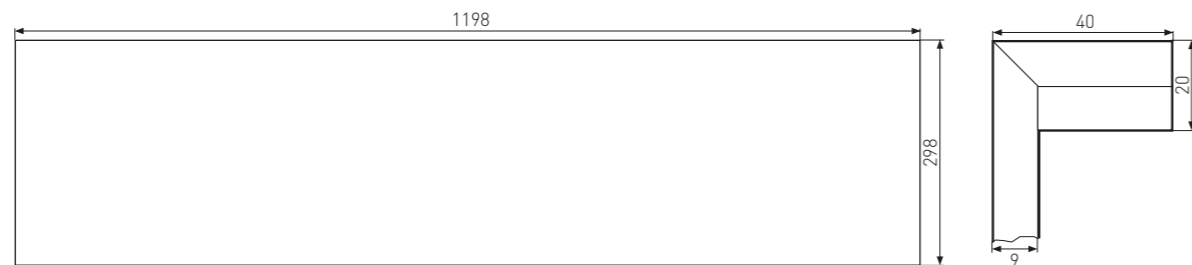

Stufenformteil | special step tile | DCF84... | 398×798×10 mm

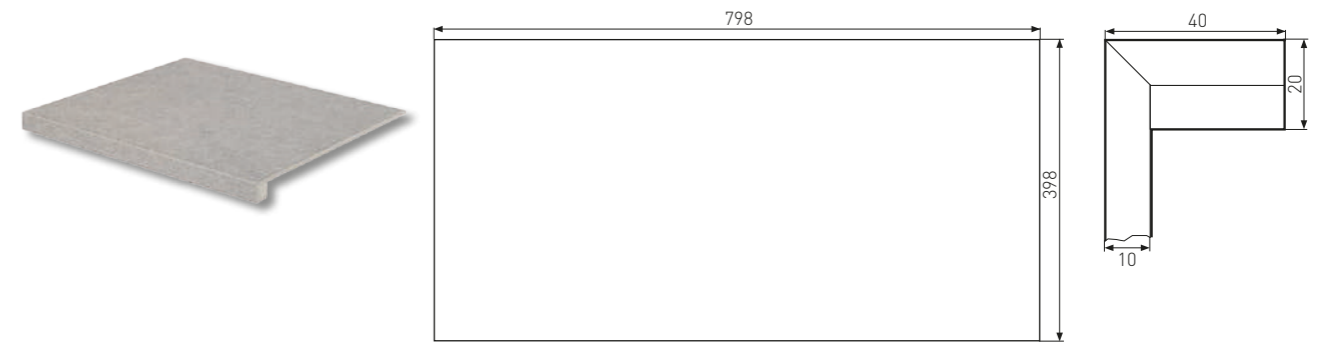

Socket | skirting plinth | DSA89... | 798×95×10 mm

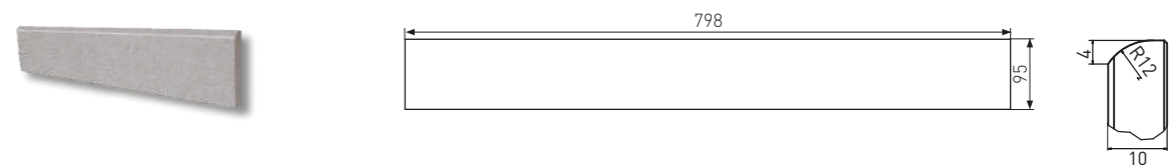

Socket | skirting plinth | DSAS4... | DSKS4... | 598×95×10 mm*

DSAS3... | DSKS3... | 598×72×9 mm**

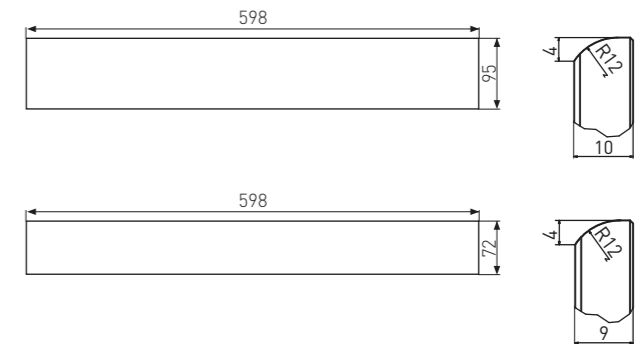

Socket | skirting plinth | DSAPS... | 448×85×8 mm

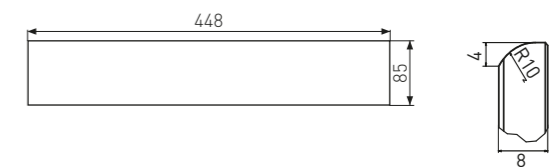

* Verfügbar solange der Vorrat reicht | Available while stocks last

** Neues Produkt in 9 mm Stärke im Laufe des Jahres 2025 verfügbar | New product in 9 mm thickness available during 2025



RAKO Object





Produkt | product



EN 14411 - L B III

Wandfliese | wall tile



30x60



298x598x8

Oberfläche | surface

matt

glänzend | glossy

relief
matt

relief
glänzend | glossy

Farbe | color

dunkelgrau
dark grey

WADV782
○ 480 | m²

WADV082
○ 480 | m²

grau
grey

WADV781
○ 480 | m²

WADV081
○ 480 | m²

hellgrau
light grey

WADV780
○ 480 | m²

WADV080
○ 480 | m²

hellgrau Dekor
light grey decor

WARV780
○ 480 | m²

WARV080
○ 480 | m²

elfenbein Dekor
ivory decor

WARV785
○ 480 | m²

WARV085
○ 480 | m²

beige
beige

WADV784
○ 480 | m²

WADV084
○ 480 | m²

elfenbein
ivory

WADV785
○ 480 | m²

WADV085
○ 480 | m²

logistische Daten | logistic information



8

8



5,56

5,56



1,44

1,44



40

40



57,60

57,60



21,3

21,3



14,8

14,8



876

876



Wxxx782
dunkelgrau | dark grey



Wxxx781
grau | grey



Wxxx780
hellgrau | light grey



Wxxx784
beige | beige



Wxxx785
elfenbein | ivory

Die Farbnuancen, die hier abgebildet sind, haben nur den Orientierungscharakter. | The colour shades shown are for orientation only.



matt



glänzend | glossy



relief



Dekor | decor | **WARVK780, WARVK080** | 298x598x8 mm



Dekor | decor | **WARVK785, WARVK085** | 298x598x8 mm





Aufgrund der hervorragenden Eigenschaften unglasierter Feinsteinzeug-Bodenfliesen mit natürlicher Steinzeichnung findet die Serie KAAMOS sowohl im Innen- als auch im Außenbereich viele Anwendungsmöglichkeiten. Die matte, glatte Oberfläche mit elegantem Kontrast glänzender Elemente garantiert eine problemlose Reinigung und Rutschfestigkeit für öffentliche Flächen.

„Lösung ohne Kompromisse.“



The excellent properties of the highly sintered unglazed tiles with natural variations in the stone design in the surface predestine the KAAMOS series for its wide range of applications both indoors and outdoors. The matt smooth surface with elegant gloss contrast ensures easy cleanability while guaranteeing anti-slip properties for public areas.

„A solution without compromises.“





Produkt product							
EN 14411 - G B1a S10 No. 030 - 059824	Bodenfliese floor tile	Bodenfliese floor tile	Bodenfliese floor tile	Bodenfliese floor tile	Bodenfliese floor tile	Bodenfliese floor tile	Bodenfliese floor tile mosaic sheet 30x30 cm
	80x80 R	40x80 R	60x60 R	30x60 R	45x45 R	30x30	10x10 R
	798x798x10	398x798x10	598x598x10* 598x598x9**	298x598x10* 298x598x9**	445x445x8	298x298x8	98x98x10* 98x98x9**
Oberfläche surface	matt	matt	matt	matt	matt	matt	matt
Rutschfestigkeit slip resistance	R10/A	R10/A	R10/A	R10/A	R10/A	R10/A	R10/B
Reibungskoeffizient - trocken sliding friction coefficient - dry	μ ≥ 0,6	μ ≥ 0,6	μ ≥ 0,6	μ ≥ 0,6	μ ≥ 0,6	μ ≥ 0,6	μ ≥ 0,6
Farbe color							
	DAK81588 ○ 700 m ²	DAK84588 ○ 720 m ²	DAK63588* DAK62588** ○ 560 m ²	DAKSE588* DAKSR588** ○ 540 m ²	DAK4H588 ○ 520 m ²	DAA34588 ○ 390 m ²	DAK12588* DAK11588** ○ 900 m ²
	DAK81587 ○ 700 m ²	DAK84587 ○ 720 m ²	DAK63587* DAK62587** ○ 560 m ²	DAKSE587* DAKSR587** ○ 540 m ²	DAK4H587 ○ 520 m ²	DAA34587 ○ 390 m ²	DAK12587* DAK11587** ○ 900 m ²
	DAK81585 ○ 700 m ²	DAK84585 ○ 720 m ²	DAK63585* DAK62585** ○ 560 m ²	DAKSE585* DAKSR585** ○ 540 m ²	DAK4H585 ○ 520 m ²	DAA34585 ○ 390 m ²	DAK12585* DAK11585** ○ 900 m ²
	DAK81586 ○ 700 m ²	DAK84586 ○ 720 m ²	DAK63586* DAK62586** ○ 560 m ²	DAKSE586* DAKSR586** ○ 540 m ²	DAK4H586 ○ 520 m ²	DAA34586 ○ 390 m ²	DAK12586* DAK11586** ○ 900 m ²
	DAK81589 ○ 700 m ²	DAK84589 ○ 720 m ²	DAK63589* DAK62589** ○ 560 m ²	DAKSE589* DAKSR589** ○ 540 m ²	DAK4H589 ○ 520 m ²	DAA34589 ○ 390 m ²	DAK12589* DAK11589** ○ 900 m ²
logistische Daten logistic information							
	2	4	3 4	6 7	6	13	10 11
	1,6	3,1	2,8 2,8	5,6 5,6	5	11	11 11
	1,28	1,28	1,08 1,44	1,08 1,26	1,21	1,18	0,91 1,00
	42	42	32 32	40 40	34	48	56 56
	53,76	53,76	34,56 46,08	43,2 50,40	41,14	56,64	50,96 56,00
	28,0	28,0	23,7 29,1	23,7 24,2	21,1	20,5	19,9 19,2
	21,9	21,9	21,9 20,2	21,9 19,2	17,4	17,4	21,9 19,2
	1 202	1 202	782 955	971 993	741	1 011	1 142 1125

























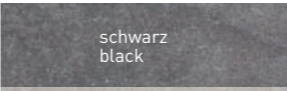



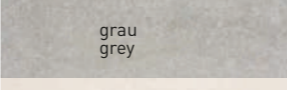



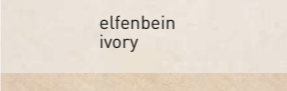



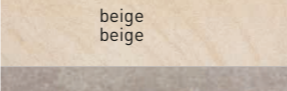

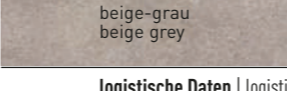
Mosaik sheet 30x30 cm mosaic sheet 30x30 cm	Stufe step tile	Stufe step tile	Stufenformteil special step tile	Socket skirting plinth	Socket skirting plinth	Socket skirting plinth
5x5 R	40x80 R	30x60 R	40x80 R	80x9,5 R	60x9,5* 60x7,2** R	45x8,5 R
48x48x10* 48x48x9**	398x798x10	298x598x10* 298x598x9**	398x798x10	798x95x10	598x95x10* 598x72x9**	445x85x8
matt	matt	matt	matt	matt	matt	matt
R10/B	R10/A	R10/A	R10/A			
μ ≥ 0,6	μ ≥ 0,6	μ ≥ 0,6	μ ≥ 0,6			
DDM06588* DDM05588** ○ 300 Netz	DCP84588 ○ 380 St	DCPSE588* DCPSR588** ○ 270 St	DCF84588 ○ 1130 St	DSA89588 ○ 210 St	DSAS4588* DSAS3588** ○ 180 St	DSAPS588 ○ 160 St
DDM06587* DDM05587** ○ 300 Netz	DCP84587 ○ 380 St	DCPSE587* DCPSR587** ○ 270 St	DCF84587 ○ 1130 St	DSA89587 ○ 210 St	DSAS4587* DSAS3587** ○ 180 St	DSAPS587 ○ 160 St
DDM06585* DDM05585** ○ 300 Netz	DCP84585 ○ 380 St	DCPSE585* DCPSR585** ○ 270 St	DCF84585 ○ 1130 St	DSA89585 ○ 210 St	DSAS4585* DSAS3585** ○ 180 St	DSAPS585 ○ 160 St
DDM06586* DDM05586** ○ 300 Netz	DCP84586 ○ 380 St	DCPSE586* DCPSR586** ○ 270 St	DCF84586 ○ 1130 St	DSA89586 ○ 210 St	DSAS4586* DSAS3586** ○ 180 St	DSAPS586 ○ 160 St
DDM06589* DDM05589** ○ 300 Netz	DCP84589 ○ 380 St	DCPSE589* DCPSR589** ○ 270 St	DCF84589 ○ 1130 St	DSA89589 ○ 210 St	DSAS4589* DSAS3589** ○ 180 St	DSAPS589 ○ 160 St
3 3	2	6 5	2	10	13 14	25
11 11	3,1	5,6 5,6	-	13,2	17,5 23,1	26,1
0,27 0,27	0,64	1,08 0,90	-	0,76	0,74 0,60	0,96
-	-	-	-	-	-	-
-	-	-	-	-	-	-
5,9 5,2	14,1	23,7 17,3	16,5	16,7	16,2 11,5	16,7
-	21,9	-	-	21,9	-	17,4
-	-	-	-	-	-	-

* Verfügbar solange der Vorrat reicht | Available while stocks last

** Neues Produkt in 9 mm Stärke im Laufe des Jahres 2025 verfügbar | New product in 9 mm thickness available during 2025



industrial outdoor

Produkt product	  	  	  
EN 14411 - G Bla STO No. 030 - 059824	Bodenfliese floor tile	Bodenfliese floor tile	Stufe step tile
	60×60 	60×60 	60×60 
	598×598×15	598×598×20	598×598×20
Oberfläche surface	matt	relief matt	relief matt
Rutschfestigkeit slip resistance	R10/A	R11/B	R11/B
Reibungskoeffizient - trocken sliding friction coefficient - dry	$\mu \geq 0,6$	$\mu \geq 0,7$	$\mu \geq 0,7$
Farbe color			
 schwarz black	DAK665588  700 m ²	DAR66588  760 m ²	DCH66588  780 St
 grau grey	DAK66587  700 m ²	DAR66587  760 m ²	DCH66587  780 St
 elfenbein ivory	DAK66585  700 m ²	DAR66585  760 m ²	DCH66585  780 St
 beige beige		DAR66586  760 m ²	DCH66586  780 St
 beige-grau beige grey		DAR66589  760 m ²	DCH66589  780 St
logistische Daten logistic information			
	2	2	2
	2,8	2,8	-
	0,72	0,72	-
	32	30	-
	23,04	21,6	-
	23,2	32,0	32,0
	32,3	44,4	-
 brutto kg	758	985	-



Farben | colors



Dxxxx588
schwarz | black



Dxxxx587
grau | grey



Dxxxx585
elfenbein | ivory

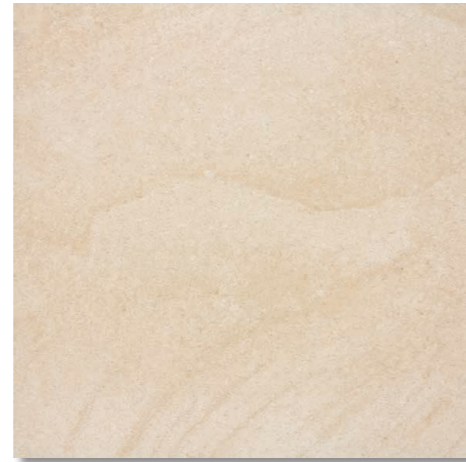

Dxxxx586
beige | beige



Dxxxx589
beige-grau | beige-grey

Die Fliesen der Serie zeichnen sich durch ein breites Farbspiel V3 aus. | All products of the entire batch show big deviations in shade difference V3.
Die Farbnuancen, die hier abgebildet sind, haben nur den Orientierungscharakter. | The colour shades shown are for orientation only.



Oberflächen | surfaces



matt
R10/A - R10/B
 $\mu \geq 0,6$



relief
SR (outdoor)
R11/B
 $\mu \geq 0,7$

SR... - Reliefoberfläche | Relief surface

Stufe | step tile | **DCP84...** | 398×798×10 mm

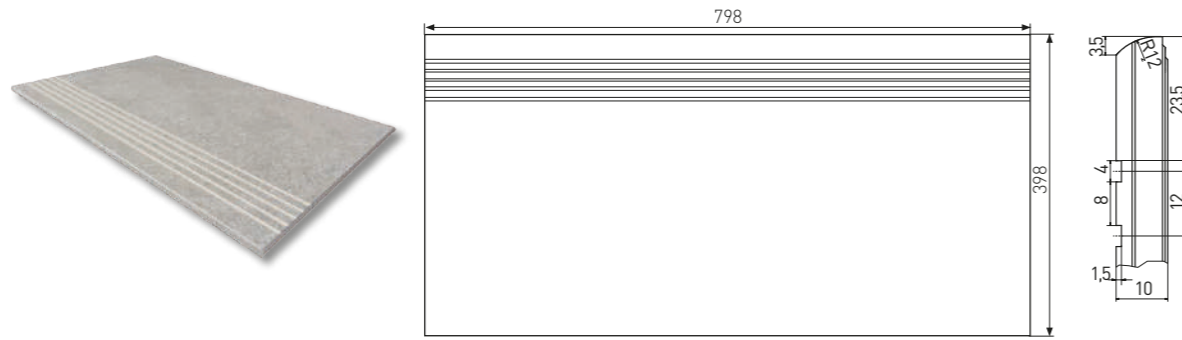

Stufe | step tile | DCPSE... | 298×598×10 mm*

DCPSR... | 298×598×9 mm**

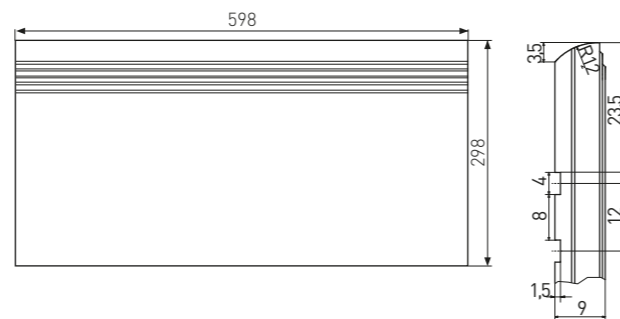

Stufenformteil | special step tile | **DCF84...** | 398×798×10 mm



Stufe | step tile | **DCH66...** | 598×598×20 mm

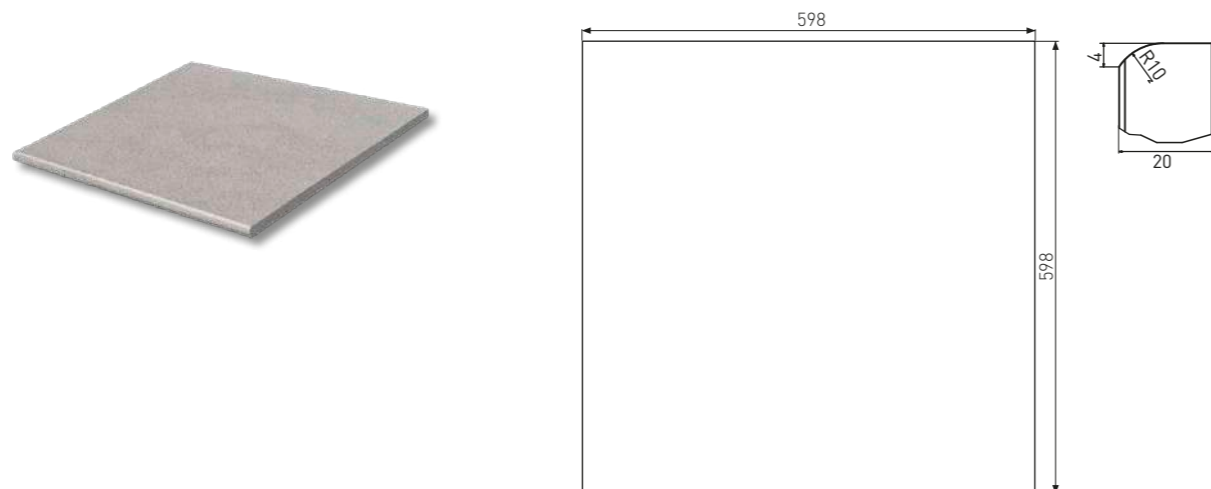

Sockel | skirting plinth | **DSA89...** | 798×95×10 mm

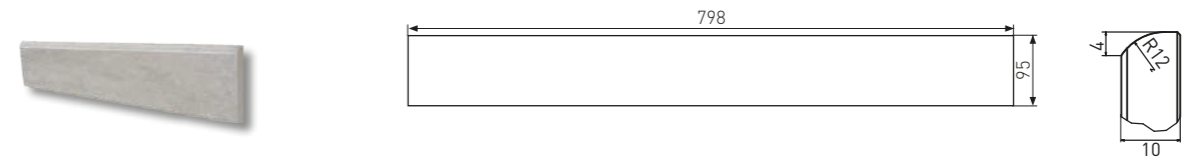

Sockel | skirting plinth | DSAS4... | 598×95×10 mm*

DSAS3... | 598×72×9 mm**

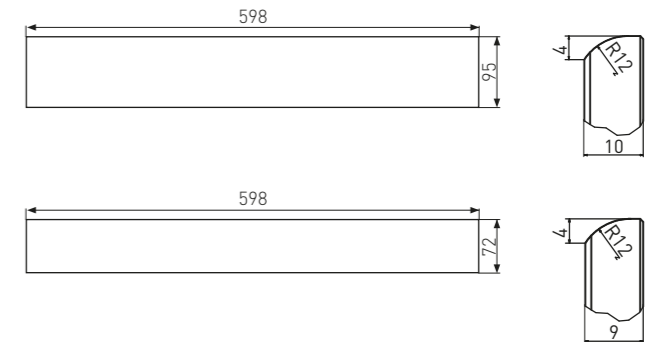

Sockel | skirting plinth | **DSAPS...** | 445×85×8 mm

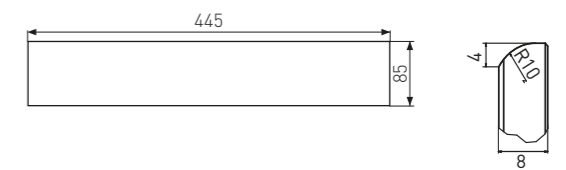

* Verfügbar solange der Vorrat reicht | Available while stocks last

** Neues Produkt in 9 mm Stärke im Laufe des Jahres 2025 verfügbar | New product in 9 mm thickness available during 2025



Qualität, Funktionalität und Beständigkeit – das waren und sind wesentliche Vorteile der Serie Taurus GRANIT. Die breite Produktpalette, die an die Serien ColorONE und ColorTWO anknüpft, unterstützt das kreative und variable Potential individueller Projekte, einschließlich einer Reihe von Sonderzubehör. Alle Oberflächen erfüllen die hohen technischen Anforderungen der internationalen Normen.

„Bewährte Qualität.“



Quality, functionality, and durability were and are the important benefits of the Taurus GRANIT series. The wide range, building on the ColorONE and ColorTWO assortments, supports the creative and variable potential of the individual projects, including a range of special supplies. All surfaces meet the high technical requirements of international standards.

„Proven quality.“







Produkt product						
EN 14411 - G Bla STO No. 030 - 059824	Stufe step tile	Stufe step tile	Außenstufe ext. step tile	Sockel skirting plinth	Sockel skirting plinth	Französischer Sockel french skirting plinth
	30×60 R	30×30	30×30	60×9,5* 60×7,2** R	30×8	30×8
	298×598×10* 298×598×9**	298×298×8	298×298×8	598×95×10* 598×72×9**	298×80×8	298×80×8
Oberfläche surface	matt	matt	relief SR7	matt	matt	matt
Rutschfestigkeit slip resistance	R10/B	R10/B	R11/B			
Reibungskoeffizient - trocken sliding friction coefficient - dry	μ ≥ 0,7	μ ≥ 0,7	μ ≥ 0,7			
Farbe color						
69 Rio Negro schwarz black	TCPSE069* TCPSR069** ○ 270 St	TCA34069 ○ 150 St	TCV34069 ○ 190 St	TSASZ069* TSAS3069** ○ 180 St	TSAKF069 ○ 110 St	TSFKF069 ○ 120 St
65 Antracit anthrazit-grau anthracite-grey	TCPSE065* TCPSR065** ○ 270 St	TCA34065 ○ 150 St	TCV34065 ○ 190 St	TSASZ065* TSAS3065** ○ 180 St	TSAKF065 ○ 110 St	TSFKF065 ○ 120 St
76 Nordic grau grey	TCPSE076* TCPSR076** ○ 270 St	TCA34076 ○ 150 St	TCV34076 ○ 190 St	TSASZ076* TSAS3076** ○ 180 St	TSAKF076 ○ 110 St	TSFKF076 ○ 120 St
78 Sierra hellgrau light grey	TCPSE078* TCPSR078** ○ 270 St	TCA34078 ○ 150 St		TSASZ078* TSAS3078** ○ 180 St	TSAKF078 ○ 110 St	TSFKF078 ○ 120 St
60 Alaska weiß white	TCPSE060* TCPSR060** ○ 270 St	TCA34060 ○ 150 St		TSASZ060* TSAS3060** ○ 180 St	TSAKF060 ○ 110 St	
62 Sahara beige beige	TCPSE062* TCPSR062** ○ 270 St	TCA34062 ○ 150 St		TSASZ062* TSAS3062** ○ 180 St	TSAKF062 ○ 110 St	TSFKF062 ○ 120 St
61 Tunis dunkelbeige dark beige	TCPSE061* TCPSR061** ○ 270 St	TCA34061 ○ 150 St	TCV34061 ○ 190 St	TSASZ061* TSAS3061** ○ 180 St	TSAKF061 ○ 110 St	TSFKF061 ○ 120 St
68 Cuba braun-grau brown-grey	TCPSE068* TCPSR068** ○ 270 St	TCA34068 ○ 150 St		TSASZ068* TSAS3068** ○ 180 St	TSAKF068 ○ 110 St	TSFKF068 ○ 120 St
74 Gobi gelb yellow		TCA34074 ○ 150 St			TSAKF074 ○ 110 St	
82 Jura rot red		TCA34082 ○ 150 St			TSAKF082 ○ 110 St	
80 Oaza grün green		TCA34080 ○ 150 St			TSAKF080 ○ 110 St	
75 Biskay blau blue		TCA34075 ○ 150 St			TSAKF075 ○ 110 St	
logistische Daten logistic information						
	6 5	14	13	13 14	23	22
	5,6 5,6	11,0	11,0	17,5 23,1	42,0	42,0
	1,08 0,9	1,27	1,18	0,74 0,6	0,55	0,53
	-	48	52	-	-	-
	-	60,96	61,36	-	-	-
	23,7 17,3	21,7	19,5	16,2 11,5	9,4	9,0
	-	17,0	17,0	-	17,0	17,0
	-	1 062	1 039	-	-	-

* Verfügbar solange der Vorrat reicht | Available while stocks last

** Neues Produkt in 9 mm Stärke im Laufe des Jahres 2025 verfügbar | New product in 9 mm thickness available during 2025

Hohlkehlssocket cove skirting	Hohlkehlssocket cove skirting	Innenecke Hohlkehlssocket inside corner skirting plinth	Außenecke Hohlkehlssocket outside corner skirting plinth
30×8	20×8	2,3×8	2,3×8
298×80×8	198×80×8	80×23×10	80×23×7
matt	matt	S	S
R10/B	R10/B		
μ ≥ 0,6	μ ≥ 0,6		
TSPKF069 ○ 130 St	TSPF6069 ○ 110 St	TSIRH069 ○ 240 St	TSERH069 ○ 240 St
TSPKF065 ○ 130 St	TSPF6065 ○ 110 St	TSIRH065 ○ 240 St	TSERH065 ○ 240 St
TSPKF076 ○ 130 St	TSPF6076 ○ 110 St	TSIRH076 ○ 240 St	TSERH076 ○ 240 St
TSPKF078 ○ 130 St		TSIRH078 ○ 240 St	TSERH078 ○ 240 St
TSPKF062 ○ 130 St	TSPF6062 ○ 110 St	TSIRH062 ○ 240 St	TSERH062 ○ 240 St
TSPKF061 ○ 130 St	TSPF6061 ○ 110 St	TSIRH061 ○ 240 St	TSERH061 ○ 240 St
TSPKF068 ○ 130 St	TSPF6068 ○ 110 St	TSIRH068 ○ 240 St	TSERH068 ○ 240 St
19	28	150	100
42,0	62,5	-	-
0,46	0,45	-	-
-	-	-	-
-	-	-	-
7,8	7,6	4,5	3,5
17,0	17,0	-	-
-	-	-	-



Produkt product			
STO No. 030 - 059824	Duschtasseneckstein shower piece corner	Duschtassenstein shower piece continuous	Hohlkehlsokkel-Rinne skirting groove
	10×10	10×10	20×7
	98×98×8	98×98×8	198×70×8
Oberfläche surface	matt	matt	S
Rutschfestigkeit slip resistance	R10/B	R10/B	
Reibungskoeffizient - trocken sliding friction coefficient - dry	$\mu \geq 0,6$	$\mu \geq 0,6$	
Farbe color			
69 Rio Negro schwarz black	TTR11069 ○ 190 St	TTP11069 ○ 190 St	TSZEF069 ○ 130 St
65 Antracit anthrazit-grau anthracite-grey	TTR11065 ○ 190 St	TTP11065 ○ 190 St	TSZEF065 ○ 130 St
76 Nordic grau grey	TTR11076 ○ 190 St	TTP11076 ○ 190 St	TSZEF076 ○ 130 St
78 Sierra hellgrau light grey			
60 Alaska weiß white			
62 Sahara beige beige			
61 Tunis dunkelbeige dark beige	TTR11061 ○ 190 St	TTP11061 ○ 190 St	TSZEF061 ○ 130 St
68 Cuba braun-grau brown-grey			
74 Gobi gelb yellow			
82 Jura rot red			
80 Oaza grün green			
75 Biskay blau blue			
logistische Daten logistic information			
	16	16	24
	100,0	100,0	71,0
	0,16	0,16	0,34
	-	-	-
	-	-	-
	3,5	3,2	7,2
	-	-	21,2
	-	-	-



Farben | colors

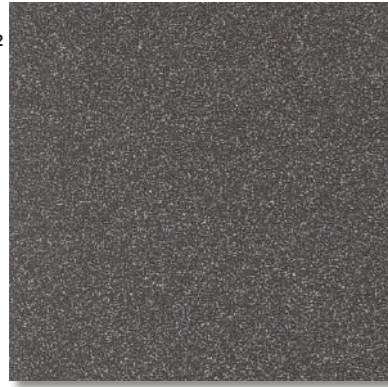

69 Rio Negro
schwarz | black



65 Antracit
anthrazit-grau | anthracite-grey



76 Nordic
grau | grey



68 Cuba
braun-grau | brown-grey



74 Gobi
gelb | yellow



82 Jura
rot | red



78 Sierra
hellgrau | light grey

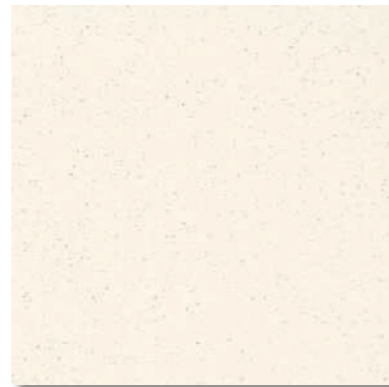

60 Alaska
weiß | white

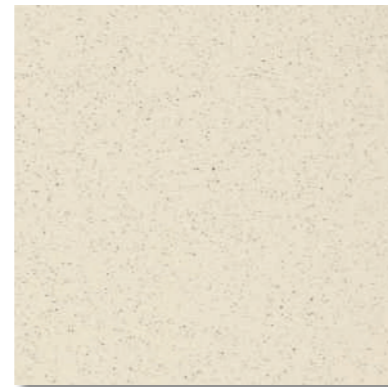

62 Sahara
beige | beige

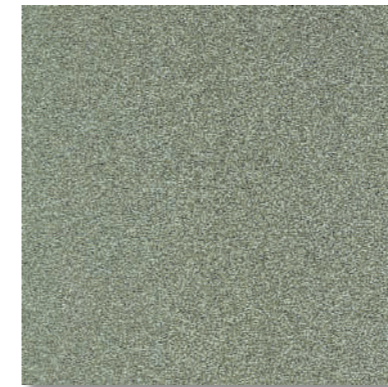

80 Oaza
grün | green

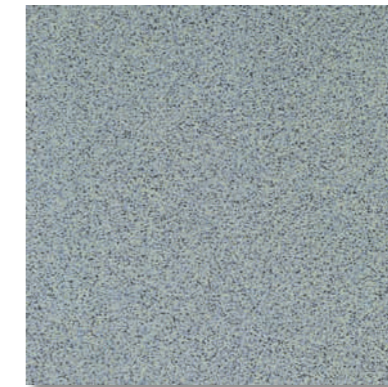

75 Biskay
blau | blue



61 Tunis
dunkelbeige | dark beige



Oberflächen | surfaces



matt

R10/B
 $\mu \geq 0,6$



relief
 SR7

R11/B
 $\mu \geq 0,7$

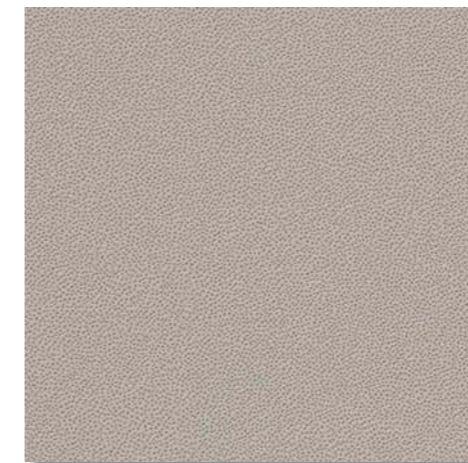

relief
 SRM

R12/B
 $\mu \geq 0,7$



Formteile | special pieces

Stufe | step tile | TCPSE... | 298x598x10 mm*
TCPSR... | 298x598x9 mm**

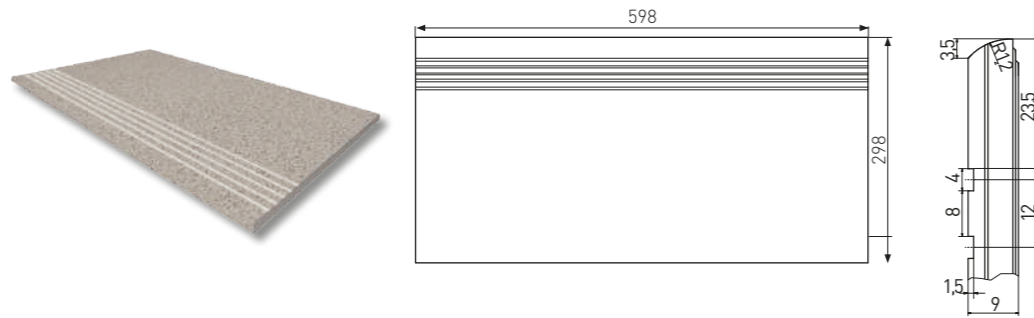

Stufe | step tile | TCA34... | 298x298x8 mm



Außenstufe | outside step tile | TCV34... | 298x298x8 mm



Socket | skirting plinth | TSASZ... | 598x95x10 mm*
TSAS3... | 598x72x9 mm **

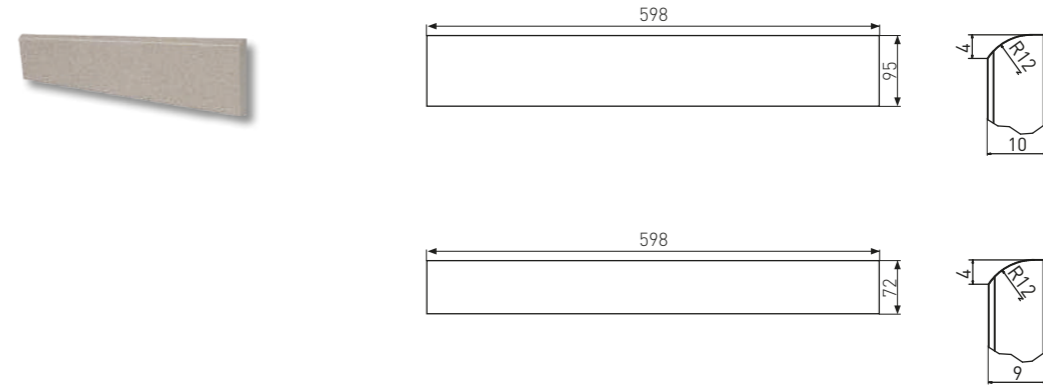

Socket | skirting plinth | TSAKF... | 298x80x8 mm

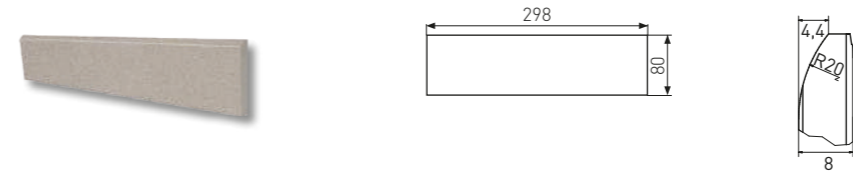

Französischer Socket | french skirting | TSFKF... | 298x80x8 mm

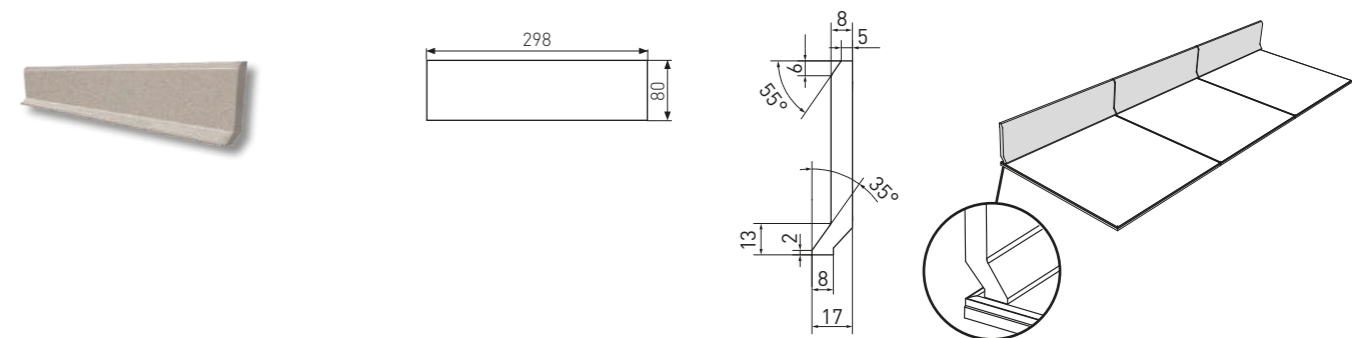

* Verfügbar solange der Vorrat reicht | Available while stocks last

** Neues Produkt in 9 mm Stärke im Laufe des Jahres 2025 verfügbar | New product in 9 mm thickness available during 2025



Formteile | special pieces

Hohlkehlsöckel | cove skirting | **TSPKF...** | 298x80x8 mm

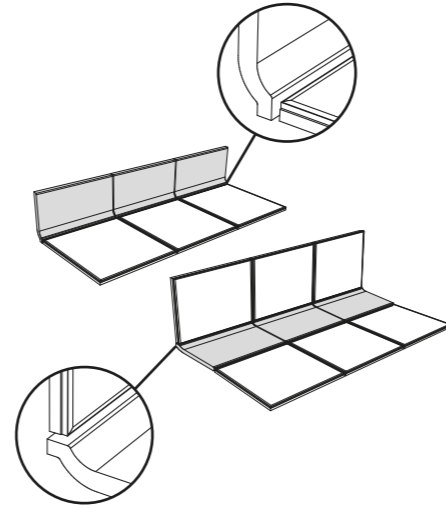
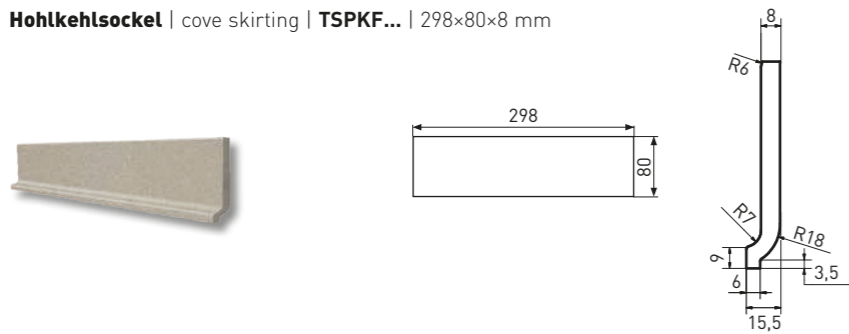

Innenecke Hohlkehlsöckel | inside corner cove skirting | **TSIRH...** | 80x23x10 mm

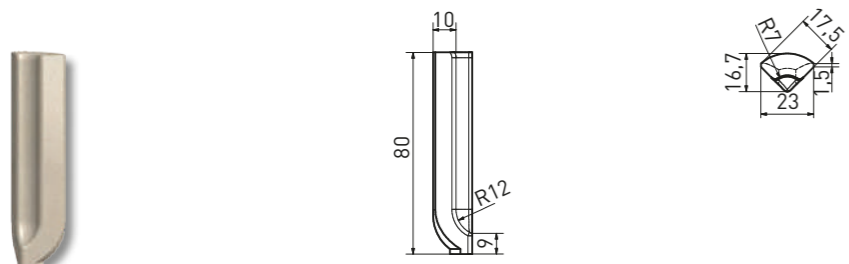

Außenecke Hohlkehlsöckel | outside corner cove skirting | **TSERH...** | 80x23x7 mm

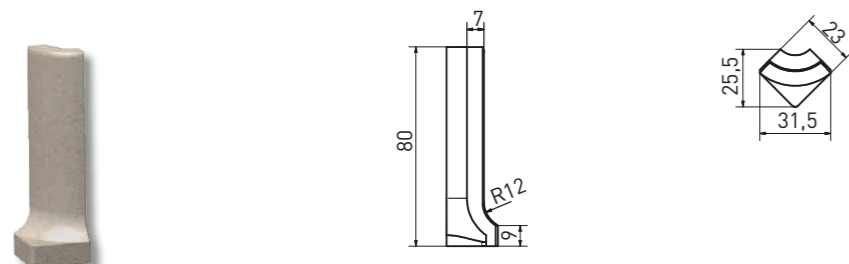

Hohlkehlsöckel | cove skirting | **TSPF6...** | 198x80x8 mm

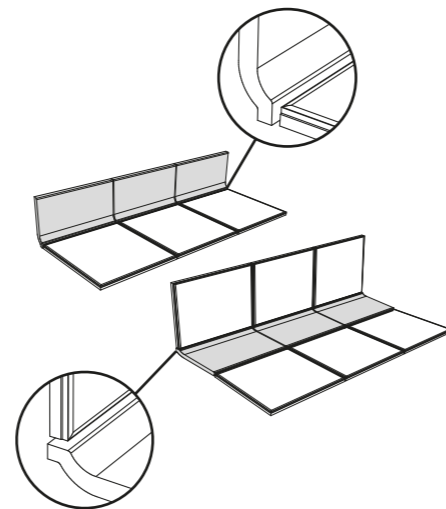
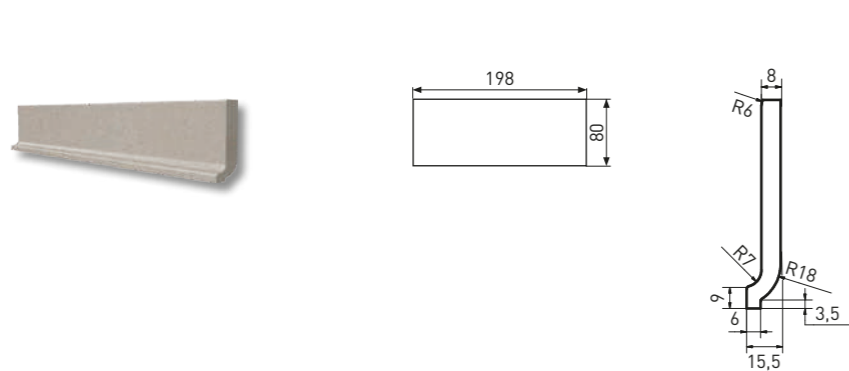

Duschtasseneckstein | shower piece - corner | **TTR11...** | 98x98x8 mm

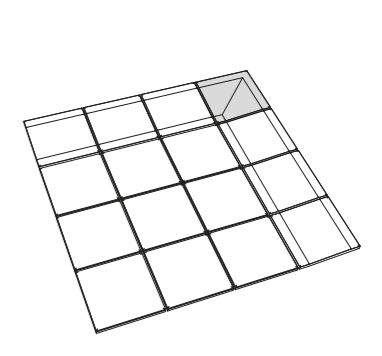
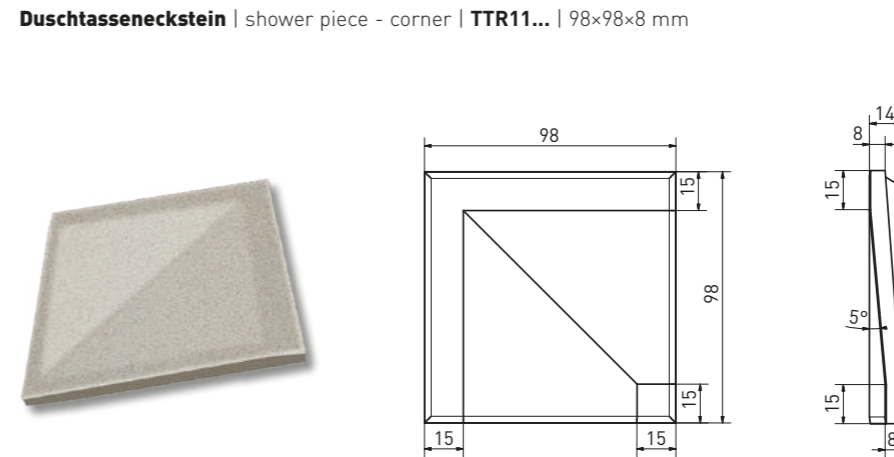

Duschtassenstein | shower piece - continuous | **TTP11...** | 98x98x8 mm

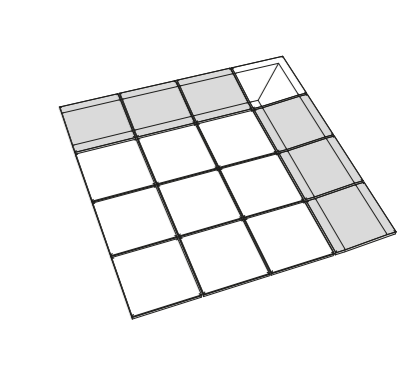

Hohlkehlsöckel-Rinne | skirting - groove | **TSZEF...** | 198x70x8 mm

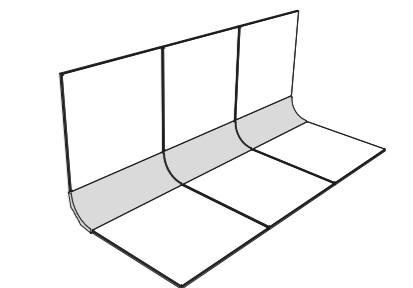
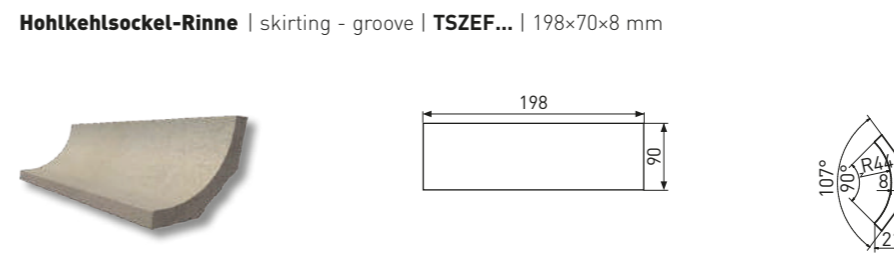



Taurus INDUSTRIAL stellt ein umfassendes Sortiment an technischen Reliefs dar. Die unglasierten Feinsteinzeug-Bodenfliesen mit hervorragenden Eigenschaften sind für Gebäude mit extremen Bedingungen wie Lebensmittel- oder Industriebetriebe mit hoher mechanischer und chemischer Beanspruchung bestimmt.

„Maximale Beständigkeit.“



Taurus INDUSTRIAL is a comprehensive range of mainly technical reliefs. Highly sintered unglazed ceramic tiles with excellent parameters are designed for buildings with extreme conditions such as food processing factories, industrial areas with high mechanical and chemical strains.

„Maximum resistance.“





Produkt product								
EN 14411 - 6 B1a	Bodenfliese floor tile	Bodenfliese floor tile						
	30×30	20×20						
	298×298×14	198×198×14						
Oberfläche surface	matt	matt	relief SRM	relief SR1	relief SR2	relief SR4	relief SR7	relief SR20
Rutschfestigkeit slip resistance	R10/B	R10/B	R12/B	R11/B V4	R12/B V4	R12/C V4	R11/B	R13/C V8
Reibungskoeffizient - trocken sliding friction coefficient - dry	$\mu \geq 0,6$	$\mu \geq 0,6$	$\mu \geq 0,7$	$\mu \geq 0,7$	$\mu \geq 0,7$	$\mu \geq 0,7$	$\mu \geq 0,7$	$\mu \geq 0,7$
Farbe color								
65 Antracit anthrazit-grau anthracite-grey	TAA3V065 ○ 720 m ²	TAA2Z065 ○ 670 m ²	TRM2Z065 ○ 700 m ²	TR12Z065 ○ 700 m ²	TR22Z065 ○ 700 m ²	TR42Z065 ○ 700 m ²	TR72Z065 ○ 700 m ²	TRA2Z065 ○ 700 m ²
76 Nordic grau grey	TAA3V076 ○ 700 m ²	TAA2Z076 ○ 660 m ²	TRM2Z076 ○ 680 m ²	TR12Z076 ○ 680 m ²	TR22Z076 ○ 680 m ²	TR42Z076 ○ 680 m ²	TR72Z076 ○ 680 m ²	TRA2Z076 ○ 680 m ²
61 Tunis dunkelbeige dark beige	TAA3V061 ○ 700 m ²	TAA2Z061 ○ 660 m ²		TR12Z061 ○ 680 m ²	TR22Z061 ○ 680 m ²	TR42Z061 ○ 680 m ²		TRA2Z061 ○ 680 m ²
logistische Daten logistic information								
	8				18			
	11,0				25,0			
	0,72				0,72			
	48				54			
	34,56				38,88			
	23,2				21,6			
	32,3				30,0			
	1 140				1 192			

Produkt product				
	Bodenfliese floor tile			
	20×20			
	198×198×8			
	relief SR1	relief SR2	relief SR4	relief SR20
	R11/B V4	R12/B V4	R12/C V4	R13/C V8
	$\mu \geq 0,7$	$\mu \geq 0,7$	$\mu \geq 0,7$	$\mu \geq 0,7$
	TR125065 ○ 520 m ²	TR225065 ○ 520 m ²	TR425065 ○ 520 m ²	TRA25065 ○ 520 m ²
	TR125076 ○ 520 m ²	TR225076 ○ 500 m ²	TR425076 ○ 500 m ²	TRA25076 ○ 500 m ²
	TR125061 ○ 500 m ²	TR225061 ○ 500 m ²	TR425061 ○ 500 m ²	TRA25061 ○ 500 m ²
			32	
			25,0	
			1,28	
			54	
			69,12	
			21,8	
			17,0	
			1 200	



Farben | colors

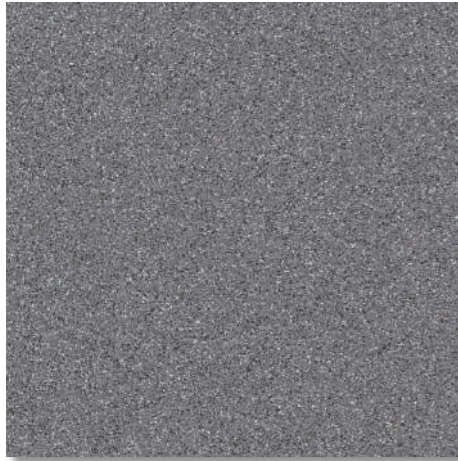

65 Antracit
anthrazit-grau | anthracite-grey



76 Nordic
grau | grey



61 Tunis
dunkelbeige | dark beige



Oberflächen | surfaces



matt R10/B
 $\mu \geq 0,6$

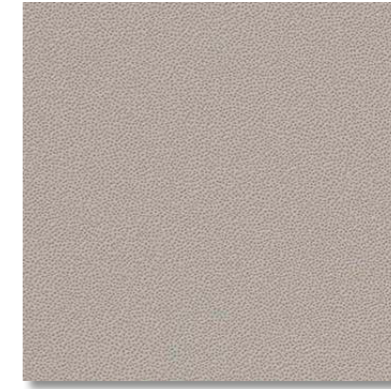

relief SRM R12/B
 $\mu \geq 0,7$



relief SR1 R11/B V4
 $\mu \geq 0,7$



relief SR2 R12/B V4
 $\mu \geq 0,7$

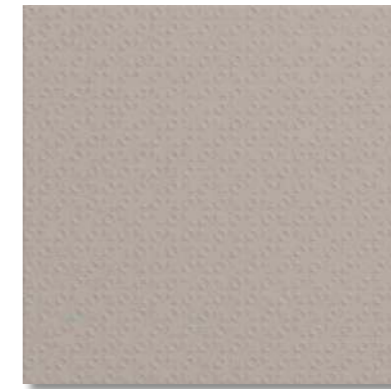

relief SR4 R12/C V4
 $\mu \geq 0,7$



relief SR7 R11/B
 $\mu \geq 0,7$

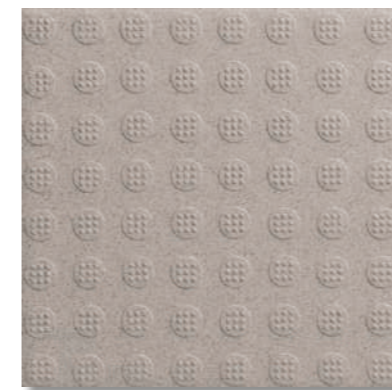

relief SR20 R13/C V8
 $\mu \geq 0,7$

Die Farbnuancen, die hier abgebildet sind, haben nur den Orientierungscharakter. | The colour shades shown are for orientation only.

SR... - Reliefoberfläche | Relief surface



Die unglasierten einfarbigen Feinsteinzeug-Bodenfliesen der Serie Taurus COLOR stehen für die hohe Qualität unserer Produktion. Kompromisslose Qualität, vielfältige Fliesenoberflächen und zusätzliches technisches Zubehör ermöglichen den Einsatz der Fliesen nicht nur in modernen, zeitlosen Innenräumen, sondern auch in Räumen, an die höhere Funktionsansprüche gestellt werden. Die Serie umfasst auch keramische Formstücke für Sehbehinderte und Blinde.

„Unendliche Gestaltungsmöglichkeiten.“



The highly sintered unglazed single-colour tiles of the Taurus COLOR series are the benchmark of our high level production. The uncompromising quality, variety of tile surfaces, and technical supplies allow the tiles to be used not only in modern, timeless interiors but also in spaces with higher functional requirements as well. The series also includes ceramic shaped bricks for the visually impaired and blind.

„Unlimited design possibilities.“





Produkt product							
EN 14411 - G Bla	Bodenfliese floor tile	Bodenfliese floor tile	Bodenfliese floor tile	Bodenfliese floor tile	Bodenfliese floor tile	Mosaik sheet 30x30 cm mosaic sheet 30x30 cm	
	60x60 R	30x60 R	30x30	20x20	10x10	5x5 R	
	598x598x10* 598x598x9**	298x598x10* 298x598x9**	298x298x8	198x198x8	98x98x8	48x48x8	
Oberfläche surface	matt	matt	matt	relief SR7	matt	matt	
Rutschfestigkeit slip resistance	R10/B	R10/B	R10/B	R11/B	R10/B	R10/B	
Reibungskoeffizient - trocken sliding friction coefficient - dry	$\mu \geq 0,6$	$\mu \geq 0,6$	$\mu \geq 0,6$	$\mu \geq 0,7$	$\mu \geq 0,6$	$\mu \geq 0,6$	
Farbe color							
19 Black schwarz black	TAK63019* TAK62019** ○ 670 m ²	TAKSE019* TAKSR019** ○ 670 m ²	TAA34019 ○ 430 m ²	TR734019 ○ 480 m ²	TAA25019 ○ 480 m ²	TAA11019 ○ 790 m ²	TDM05019 ○ 300 Netz
07 Dark Grey dunkelgrau dark grey	TAK63007* TAK62007** ○ 670 m ²	TAKSE007* TAKSR007** ○ 670 m ²	TAA34007 ○ 430 m ²	TR734007 ○ 480 m ²	TAA25007 ○ 480 m ²	TAA11007 ○ 790 m ²	TDM05007 ○ 300 Netz
06 Grey grau grey	TAK63006* TAK62006** ○ 560 m ²	TAKSE006* TAKSR006** ○ 560 m ²	TAA34006 ○ 410 m ²	TR734006 ○ 460 m ²	TAA25006 ○ 470 m ²	TAA11006 ○ 790 m ²	TDM05006 ○ 300 Netz
03 Light Grey hellgrau light grey	TAK63003* TAK62003** ○ 710 m ²		TAA34003 ○ 430 m ²	TR734003 ○ 480 m ²	TAA25003 ○ 480 m ²	TAA11003 ○ 790 m ²	TDM05003 ○ 300 Netz
11 White weiß white	TAK63011* TAK62011** ○ 820 m ²		TAA34011 ○ 620 m ²		TAA25011 ○ 550 m ²	TAA11011 ○ 790 m ²	TDM05011 ○ 300 Netz
10 Ivory elfenbein ivory	TAK63010* TAK62010** ○ 560 m ²		TAA34010 ○ 410 m ²	TR734010 ○ 460 m ²	TAA25010 ○ 470 m ²	TAA11010 ○ 790 m ²	TDM05010 ○ 300 Netz
25 Tobacco braun-grau brown-grey	TAK63025* TAK62025** ○ 670 m ²		TAA34025 ○ 430 m ²	TR734025 ○ 480 m ²	TAA25025 ○ 480 m ²	TAA11025 ○ 790 m ²	TDM05025 ○ 300 Netz
logistische Daten logistic information							
	3 4	6 7	14	32	12	4	
	2,8 2,8	5,6 5,6	11,0	25,0	11,0	11,0	
	1,08 1,44	1,08 1,26	1,27	1,28	1,09	0,36	
	32 32	40 40	48	54	56	-	
	34,56 46,08	43,2 50,40	60,96	69,12	61,04	-	
	23,7 29,1	23,7 24,2	21,6	21,8	18,5	6,0	
	21,9 20,2	21,9 19,2	17,0	17,0	17,0	17,0	
	782 955	971 993	1 062	1 200	1 063	-	

* Verfügbar solange der Vorrat reicht | Available while stocks last

** Neues Produkt in 9 mm Stärke im Laufe des Jahres 2025 verfügbar | New product in 9 mm thickness available during 2025



Produkt product							
EN 14411 - G B1a S10 No. 030-059824	Stufe step tile	Sicherheitsstufen- profil step piece with riser	Spezielle keramische Formteile special floor tile		Stufe step tile	Socket skirting plinth	Socket skirting plinth
	30×60 R	60×5 R 60×2	30×30		30×30	60×9,5 60×7,2** R	30×8
	298×598×10* 298×598×9**	598×50×10* 598×20×10* 598×50×9** 598×20×9**	298×298×9		298×298×8	598×95×10* 598×72×9**	298×80×8
Oberfläche surface	matt	matt	relief go	relief stop	matt	matt	matt
Rutschfestigkeit slip resistance	R10/B	R10/B	R11/A	R11/A	R10/B		
Reibungskoeffizient - trocken sliding friction coefficient - dry	μ ≥ 0,7	μ ≥ 0,7	μ ≥ 0,7	μ ≥ 0,7	μ ≥ 0,7		
barva color							
19 Black schwarz black	TCPSE019* TCPSR019** ○ 270 St	TCPV019* TCPVU019** ○ 330 set	TTG35019 ○ 350 St	TTS35019 ○ 350 St	TCP34019 ○ 160 St	TSASZ019* TSAS3019** ○ 180 St	TSAKF019 ○ 110 St
07 Dark Grey dunkelgrau dark grey	TCPSE007* TCPSR007** ○ 270 St				TCP34007 ○ 160 St	TSASZ007* TSAS3007** ○ 180 St	TSAKF007 ○ 110 St
06 Grey grau grey	TCPSE006* TCPSR006** ○ 270 St				TCP34006 ○ 160 St	TSASZ006* TSAS3006** ○ 180 St	TSAKF006 ○ 110 St
03 Light Grey hellgrau light grey	TCPSE003* TCPSR003** ○ 270 St				TCP34003 ○ 160 St	TSASZ003* TSAS3003** ○ 180 St	TSAKF003 ○ 110 St
11 White weiß white	TCPSE011* TCPSR011** ○ 270 St				TCP34011 ○ 170 St	TSASZ011* TSAS3011** ○ 180 St	TSAKF011 ○ 110 St
10 Ivory elfenbein ivory	TCPSE010* TCPSR010** ○ 270 St	TCPV010* TCPVU010** ○ 330 set	TTG35010 ○ 350 St	TTS35010 ○ 350 St	TCP34010 ○ 160 St	TSASZ010* TSAS3010** ○ 180 St	TSAKF010 ○ 110 St
25 Tobacco braun-grau brown-grey	TCPSE025* TCPSR025** ○ 270 St				TCP34025 ○ 160 St	TSASZ025* TSAS3025** ○ 180 St	TSAKF025 ○ 110 St
logistická data logistic information							
	6 5	16 16	9		13	13 14	23
	5,6 5,6	-	11,0		11,0	17,5 23,1	42,0
	1,08 0,9	-	0,81		1,18	0,74 0,6	0,55
	-	-	42		52	-	-
	-	-	34,36		61,36	-	-
	23,7 17,3	15,2 14,4	18,0		19,5	16,2 11,5	9,4
	-	-	22,2		17,0	-	17,0
	-	-	780		1 039	-	-

* Verfügbar solange der Vorrat reicht | Available while stocks last

** Neues Produkt in 9 mm Stärke im Laufe des Jahres 2025 verfügbar | New product in 9 mm thickness available during 2025

Hohlkehlssocket cove skirting	Hohlkehlssocket cove skirting	Innenecke Hohlkehlssocket inside corner cove skirting	Außenecke Hohlkehlssocket outside corner cove skirting	Duschasseneck- stein shower piece corner	Duschassenstein shower piece continuous
30×8	20×8	2,3×8	2,3×8	10×10	10×10
298×80×8	198×80×8	23×80×10	23×80×7	98×98×8	98×98×8
matt	matt	S	S	matt	matt
R10/B	R10/B			R10/B	R10/B
μ ≥ 0,6	μ ≥ 0,6			μ ≥ 0,6	μ ≥ 0,6
TSPKF019 ○ 130 St	TSPF6019 ○ 110 St	TSIRH019 ○ 240 St	TSERH019 ○ 240 St	TTR11019 ○ 190 St	TTP11019 ○ 190 St
TSPKF007 ○ 130 St	TSPF6007 ○ 110 St	TSIRH007 ○ 240 St	TSERH007 ○ 240 St	TTR11007 ○ 190 St	TTP11007 ○ 190 St
TSPKF006 ○ 130 St	TSPF6006 ○ 110 St	TSIRH006 ○ 240 St	TSERH006 ○ 240 St	TTR11006 ○ 190 St	TTP11006 ○ 190 St
TSPKF003 ○ 130 St	TSPF6003 ○ 110 St	TSIRH003 ○ 240 St	TSERH003 ○ 240 St	TTR11003 ○ 190 St	TTP11003 ○ 190 St
TSPKF010 ○ 130 St	TSPF6010 ○ 110 St	TSIRH010 ○ 240 St	TSERH010 ○ 240 St	TTR11010 ○ 190 St	TTP11010 ○ 190 St
TSPKF025 ○ 130 St	TSPF6025 ○ 110 St	TSIRH025 ○ 240 St	TSERH025 ○ 240 St	TTR11025 ○ 190 St	TTP11025 ○ 190 St
19	28	150	100	16	16
42,0	62,5	-	-	100,0	100,0
0,46	0,45	-	-	0,16	0,16
-	-	-	-	-	-
-	-	-	-	-	-
7,8	7,6	4,5	3,5	3,5	3,2
17,0	17,0	-	-	-	-
-	-	-	-	-	-



Farben | colors



19 Black
schwarz | black



07 Dark Grey
dunkelgrau | dark grey

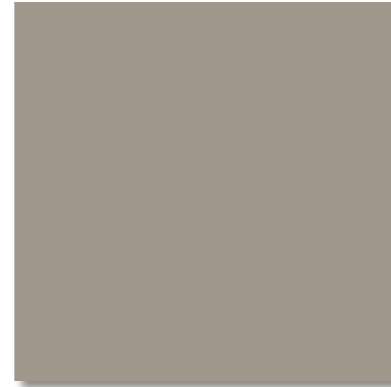

06 Grey
grau | grey

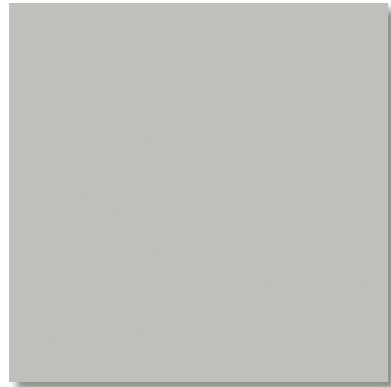

03 Light Grey
hellgrau | light grey

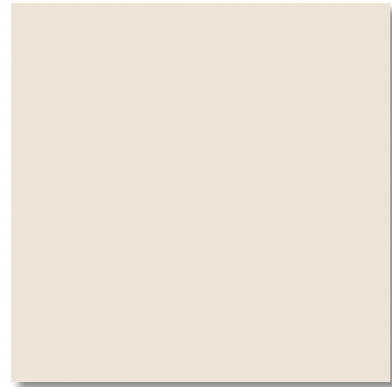

11 White
weiß | white

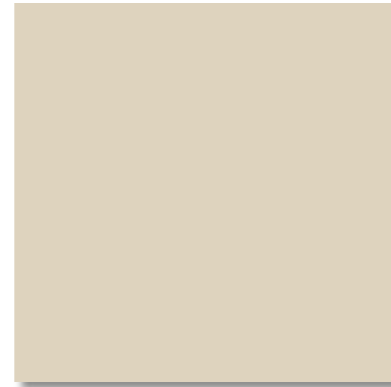

10 Ivory
elfenbein | ivory



25 Tobacco
braun-grau | brown-grey



Oberflächen | surfaces



matt

R10/B
 $\mu \geq 0,6$



relief
SR7

R11/B
 $\mu \geq 0,7$



Formteile | special pieces

Stufe | step tile | TCPSE... | 298×598×10 mm*
 TCPSR... | 298×598×9 mm**

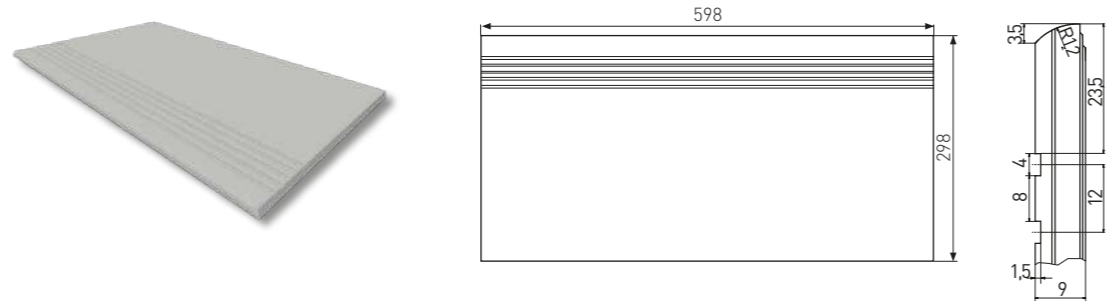

Stufe | step tile | TCP34... | 298×298×8 mm



Socket | skirting plinth | TSASZ... | 598×95×10 mm*
 TSAS3... | 598×72×9 mm**

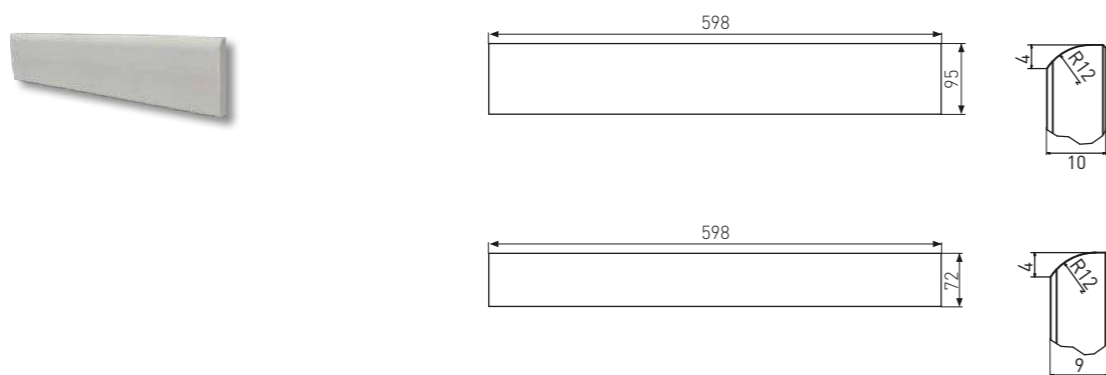

Socket | skirting plinth | TSAKF... | 298×80×8 mm

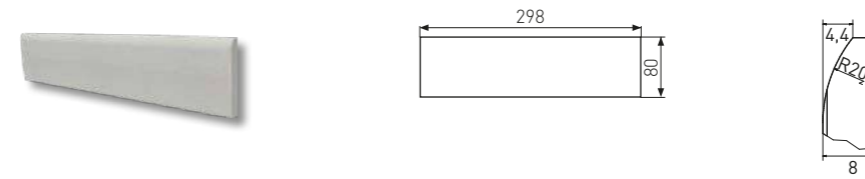

Hohlkehsocket | cove skirting | TSPKF... | 298×80×8 mm

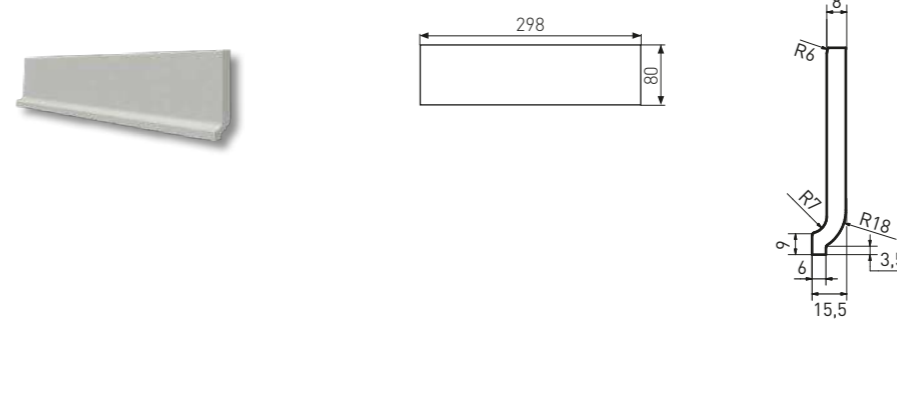

Hohlkehsocket | cove skirting | TSPF6... | 198×80×8 mm

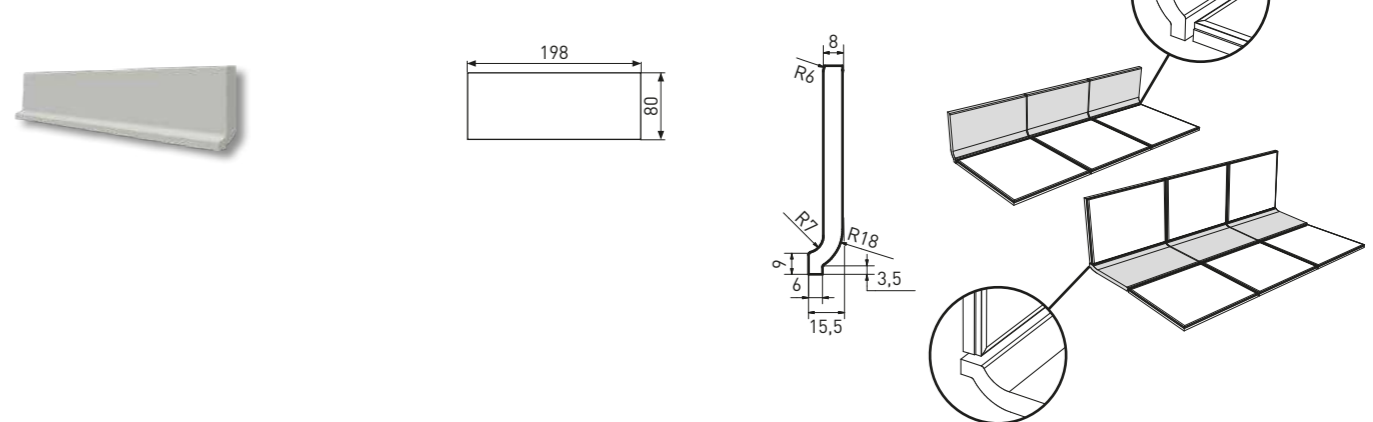

* Verfügbar solange der Vorrat reicht | Available while stocks last

** Neues Produkt in 9 mm Stärke im Laufe des Jahres 2025 verfügbar | New product in 9 mm thickness available during 2025



Innenecke Hohlkehlsocle | inside corner cove skirting | **TSIRH...** | 23x80x10 mm

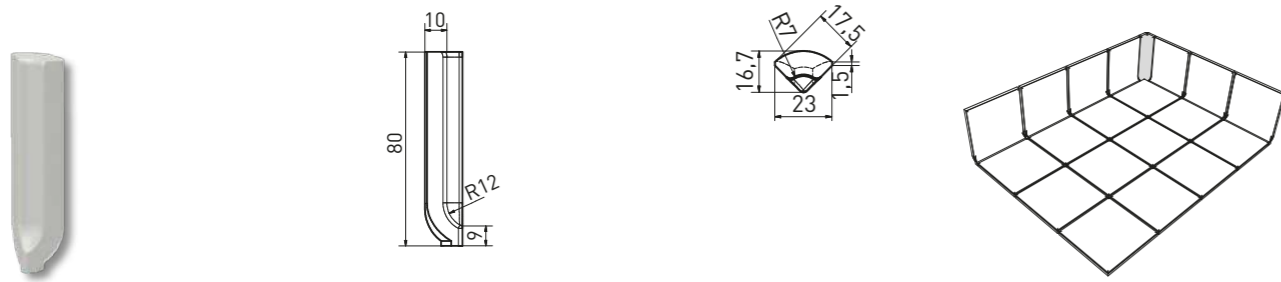

Duschtassenstein | shower piece - continuous | **TTP11...** | 98x98x8 mm | (ABS)

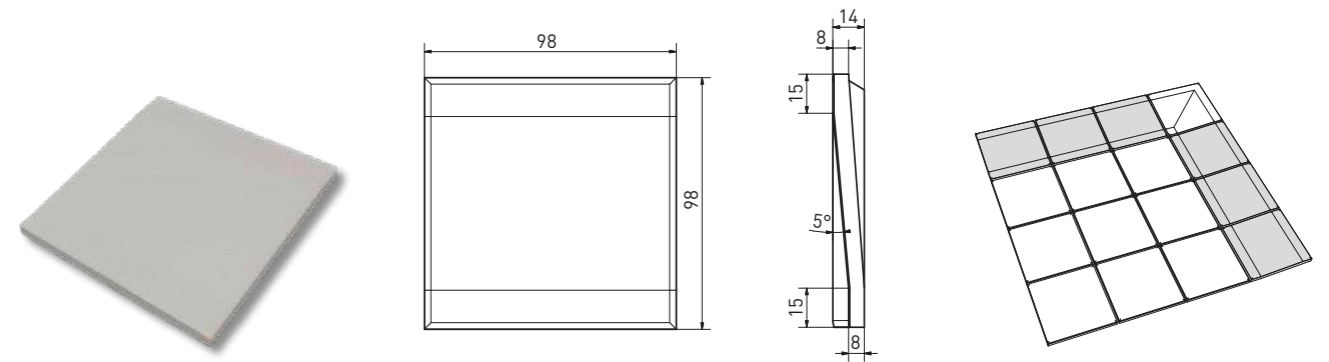

Außenecke Hohlkehlsocle | outside corner cove skirting | **TSERH...** | 23x80x7 mm

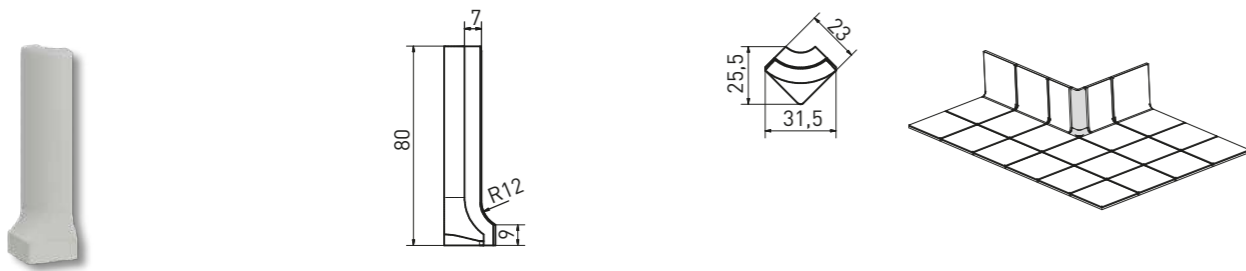

Duschtasseneckstein | shower piece - corner | **TTR11...** | 98x98x8 mm | (ABS)

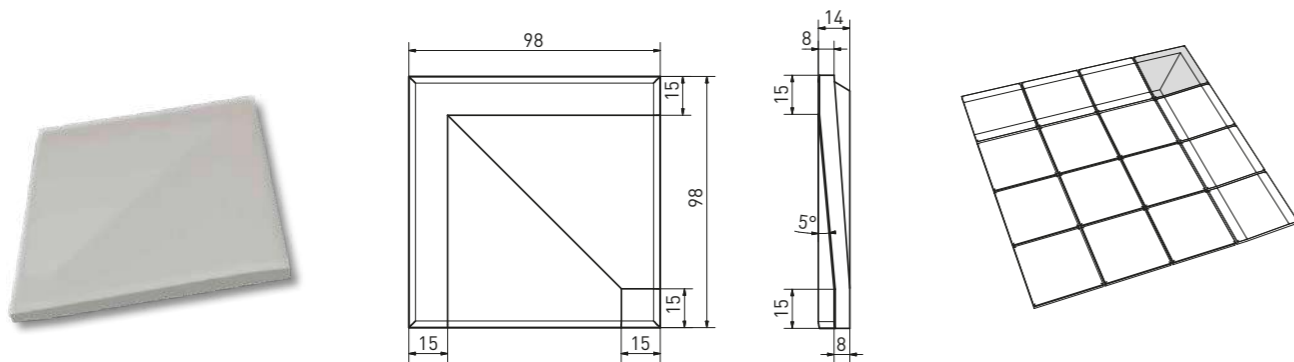



Formteile | special pieces

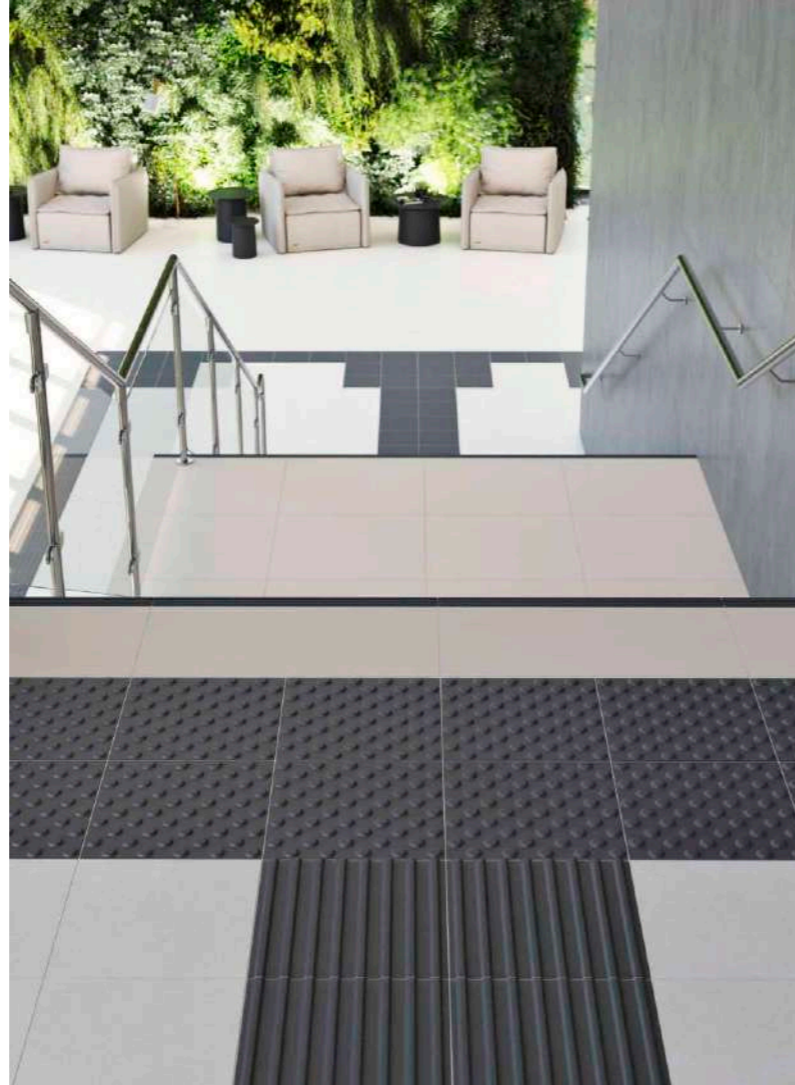
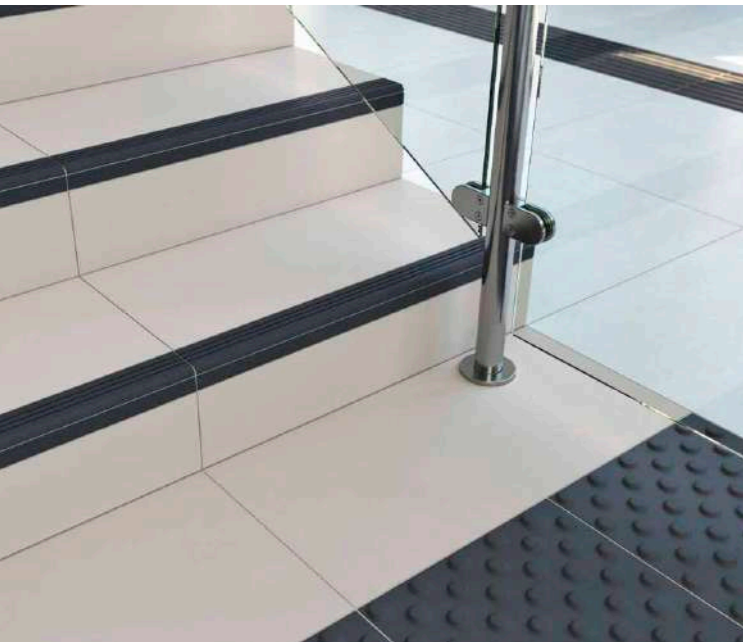

Sicherheitsstufenprofil | step piece with riser | TCPVN... | 598x50x10 mm | 598x20x10 mm*
 TCPVU.. | 598x50x9mm | 598x20x9 mm**



TCPVN010* | TCPVU010**



TCPVN019* | TCPVU019**

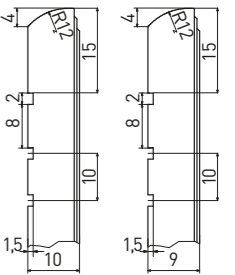
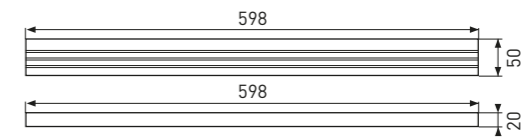
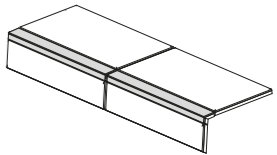

Spezielle keramische Formteile für Sehschwache und Blinde | special ceramic shaped tiles for the visually impaired persons

relief go



TTG35010



TTG35019

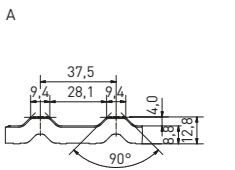

relief stop

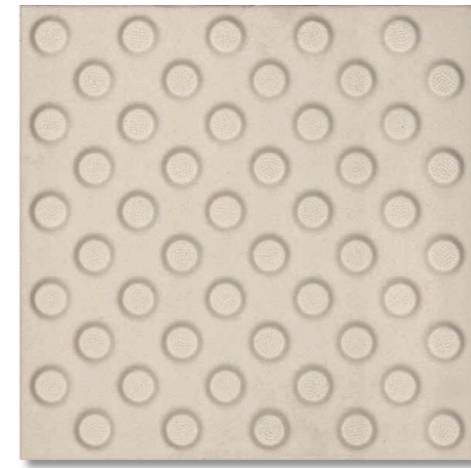

TTS35010

elfenbein | ivory

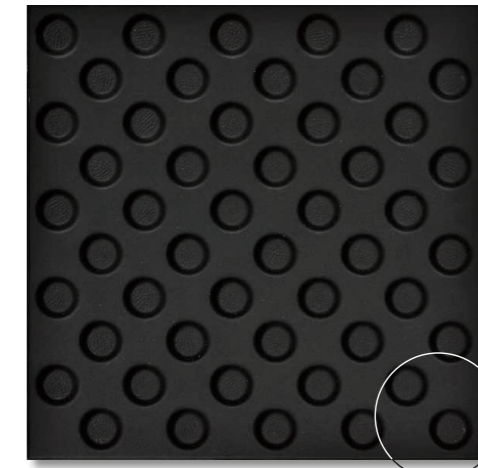

TTS35019

schwarz | black

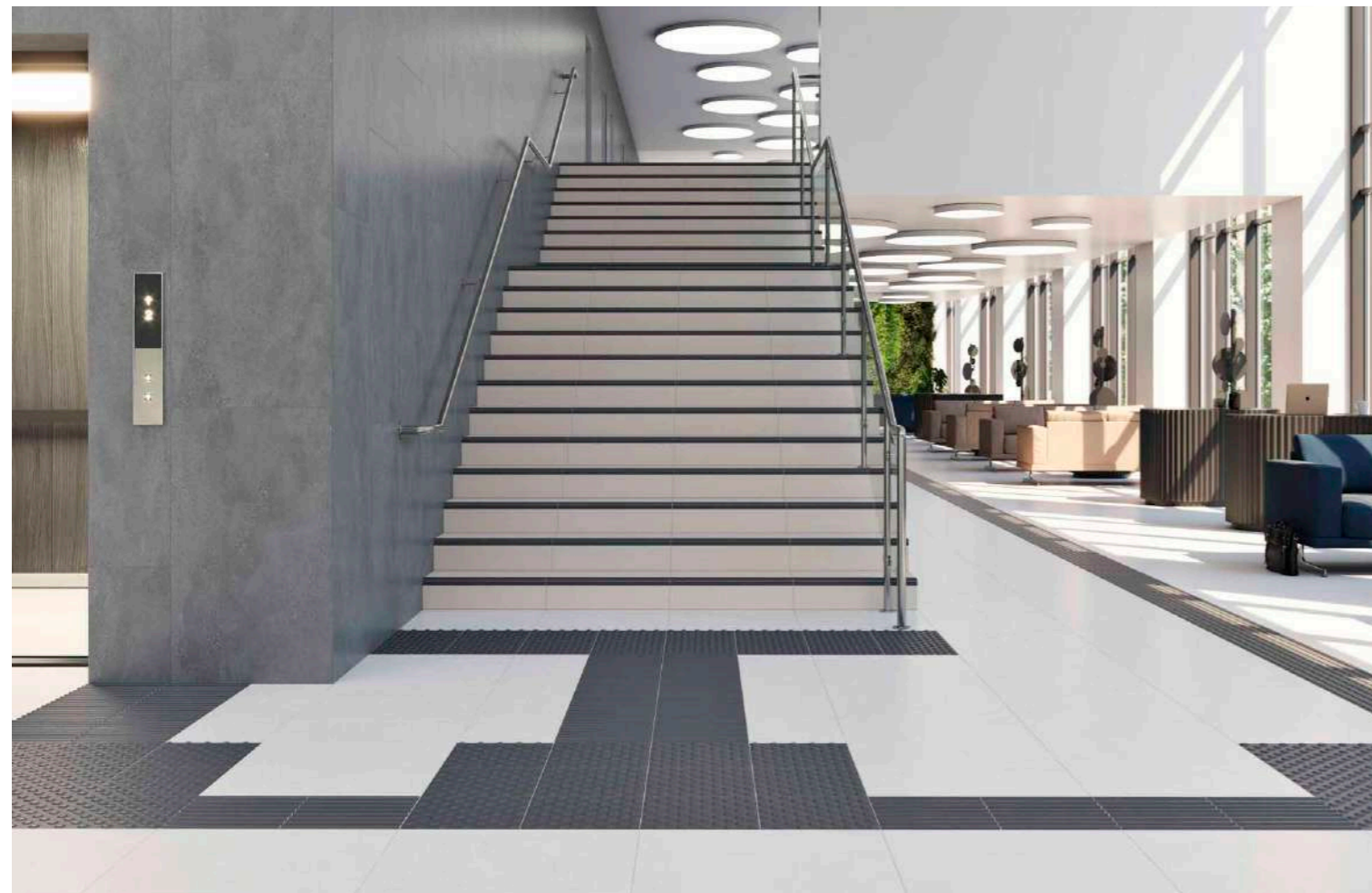
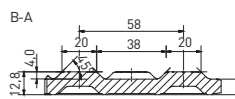
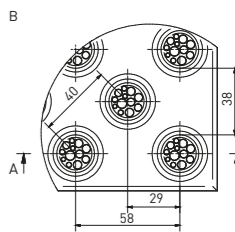

* Verfügbar solange der Vorrat reicht | Available while stocks last

** Neues Produkt in 9 mm Stärke im Laufe des Jahres 2025 verfügbar | New product in 9 mm thickness available during 2025



Das Farbspektrum der zwölf kräftigen und zwölf neutralen Farben der ColorONE-Serie ist in Hinblick auf Farbe und Format perfekt auf die glasierten ColorTWO-Bodenfliesen abgestimmt. Die glänzende und die matte Oberfläche der Wandfliesen ist in einem breiten Angebot an Modulformaten vertreten. Die Fliesen ermöglichen es Planern und Architekten, Innenräume mit ihrer eigenen Handschrift zu gestalten.

„Kreativität ohne Grenzen.“



The colour spectrum of the twelve intense and twelve neutral colours of the ColorONE series is perfectly matched in colour and format to the ColorTWO glazed tiles. The glossy and matt surface of the wall tiles is represented in a wide range of modular formats. The wall tiles allow designers and architects to create interiors with their own signature.

„Endless creativity.“





Produkt product								
EN 14411 - L BIII	Wandfliese - rektifiziert rectified wall tile		Wandfliese - rektifiziert rectified wall tile					
	40x120 R		30x90 R					
	398x1198x10		298x898x10* 298x898x8**					
Oberfläche surface	matt	glänzend glossy	matt	glänzend glossy	relief matt Lamelle lamella	relief glänzend glossy Lamelle lamella	relief matt Penta	relief glänzend glossy Penta
Farbe color								
RAL 0001500 schwarz black								
RAL 0004000 anthrazit-grau anthracite-grey								
RAL 0805005 dunkelgrau dark grey								
RAL 0607005 grau grey			WAKV5110 ○ 710 m ²	WAKV5010 ○ 710 m ²				
RAL 0008500 hellgrau light grey			WAKV5112 ○ 710 m ²	WAKV5012 ○ 710 m ²				
WHITE weiß white	WAKV6104 ○ 650 m ²	WAKV6000 ○ 650 m ²	WAKV5104* WAKVN104** ○ 660 m ²	WAKV5000* WAKVN000** ○ 660 m ²	WR1V5104 ○ 750 m ²	WR1V5000 ○ 750 m ²	WR2V5104* WR2VN104** ○ 750 m ²	WR2V5000* WR2VN000** ○ 750 m ²
RAL 0709010 hellbeige light beige			WAKV5107 ○ 710 m ²	WAKV5007 ○ 710 m ²				
RAL 0508010 beige beige			WAKV5108 ○ 710 m ²	WAKV5008 ○ 710 m ²				
RAL 0607020 dunkelbeige dark beige								
RAL0607010 beige-grau beige-grey								
RAL 0805010 grau-beige grey-beige								
RAL 0502010 dunkelbraun dark brown								
logistische Daten logistic information								
	3		4 5				8	
	2,1		3,7 3,7				5,56	
	1,44		1,08 1,35				1,44	
	21		30 30				40	
	30,24		32,40 40,50				57,6	
	29		20 20				21,3	
	20,1		18,5 14,8				14,8	
	633		625 625				876	

* Verfügbar solange der Vorrat reicht | Available while stocks last

** Neues Produkt in 8 mm Stärke im Laufe des Jahres 2025 verfügbar | New product in 8 mm thickness available during 2025

Produkt product								
EN 14411 - L BIII	Wandfliese - rektifiziert rectified wall tile		Wandfliese - rektifiziert rectified wall tile					
	30x60 R							
	298x598x8							
Oberfläche surface	matt	glänzend glossy	relief matt Lamelle lamella	relief glänzend glossy Lamelle lamella	relief matt Penta	relief glänzend glossy Penta		
Farbe color								
RAL 0001500 schwarz black								
RAL 0004000 anthrazit-grau anthracite-grey								
RAL 0805005 dunkelgrau dark grey								
RAL 0607005 grau grey	WAKVK110 ○ 500 m ²	WAKVK010 ○ 500 m ²						
RAL 0008500 hellgrau light grey	WAKVK112 ○ 500 m ²	WAKVK012 ○ 500 m ²						
WHITE weiß white	WAKVK104 ○ 480 m ²	WAKVK000 ○ 480 m ²	WR1VK104 ○ 500 m ²	WR1VK000 ○ 500 m ²	WR2VK104 ○ 500 m ²	WR2VK000 ○ 500 m ²		
RAL 0709010 hellbeige light beige	WAKVK107 ○ 500 m ²	WAKVK007 ○ 500 m ²						
RAL 0508010 beige beige	WAKVK108 ○ 500 m ²	WAKVK008 ○ 500 m ²						
RAL 0607020 dunkelbeige dark beige								
RAL0607010 beige-grau beige-grey								
RAL 0805010 grau-beige grey-beige								
RAL 0502010 dunkelbraun dark brown								
logistische Daten logistic information								
							8	
							5,56	
							1,44	
							40	
							57,6	
							21,3	
							14,8	
							876	



Produkt product								
EN 14411 - L BIII	Wandfliese wall tile						Wandfliese wall tile	
	30×60						20×60	
	298×598×8						198×598×10	
Oberfläche surface	matt	glänzend glossy	relief matt gewellt wave	relief glänzend glossy gewellt wave	relief matt geschpachtelt spattle	relief glänzend glossy geschpachtelt spattle	matt	glänzend glossy
Farbe color								
RAL 0001500 schwarz black								
RAL 0004000 anthrazit-grau anthracite-grey								
RAL 0805005 dunkelgrau dark grey								
RAL 0607005 grau grey	WAAVK110 ○ 480 m ²	WAAVK010 ○ 480 m ²					WAAVE110 ○ 480 m ²	WAAVE010 ○ 480 m ²
RAL 0008500 hellgrau light grey	WAAVK112 ○ 480 m ²	WAAVK012 ○ 480 m ²					WAAVE112 ○ 480 m ²	WAAVE012 ○ 480 m ²
WHITE weiß white	WAAVK104 ○ 430 m ²	WAAVK000 ○ 430 m ²	WARVK104 ○ 480 m ²	WARVK000 ○ 480 m ²	WAGVK104 ○ 480 m ²	WAGVK000 ○ 480 m ²	WAAVE104 ○ 430 m ²	WAAVE000 ○ 430 m ²
RAL 0709010 hellbeige light beige	WAAVK107 ○ 480 m ²	WAAVK007 ○ 480 m ²					WAAVE107 ○ 480 m ²	WAAVE007 ○ 480 m ²
RAL 0508010 beige beige	WAAVK108 ○ 480 m ²	WAAVK008 ○ 480 m ²					WAAVE108 ○ 480 m ²	WAAVE008 ○ 480 m ²
RAL 0607020 dunkelbeige dark beige								
RAL0607010 beige-grau beige-grey								
RAL 0805010 grau-beige grey-beige								
RAL 0502010 dunkelbraun dark brown								
logistische Daten logistic information								
	8						9	
	5,56						8,3	
	1,44						1,08	
	40						42	
	57,6						45,36	
	21,3						20,0	
	14,8						18,5	
	876						865	

Produkt product						
Wandfliese wall tile	Wandfliese wall tile				Wandfliese wall tile	
	20×40				25×33	
	198×398×7				250×330×7	
Oberfläche surface	matt	glänzend glossy	matt	glänzend glossy	relief matt gewellt wave	relief glänzend glossy gewellt wave
Farbe color						
WAAMB732 ○ 500 m ²	WAAMB779 ○ 500 m ²					
WAAMB765 ○ 500 m ²	WAAMB755 ○ 500 m ²					
WAAMB111 ○ 500 m ²	WAAMB011 ○ 500 m ²	WAAKB111 ○ 490 m ²	WAAKB011 ○ 490 m ²			
WAAMB110 ○ 440 m ²	WAAMB010 ○ 440 m ²	WAAKB110 ○ 430 m ²	WAAKB010 ○ 430 m ²			
WAAMB112 ○ 440 m ²	WAAMB012 ○ 440 m ²	WAAKB112 ○ 430 m ²	WAAKB012 ○ 430 m ²			
WAAMB104 ○ 390 m ²	WAAMB000 ○ 390 m ²	WAAKB104 ○ 360 m ²	WAAKB000 ○ 360 m ²	WARKB104 ○ 350 m ²	WARKB000 ○ 350 m ²	
WAAMB107 ○ 440 m ²	WAAMB007 ○ 440 m ²	WAAKB107 ○ 430 m ²	WAAKB007 ○ 430 m ²			
WAAMB108 ○ 440 m ²	WAAMB008 ○ 440 m ²	WAAKB108 ○ 430 m ²	WAAKB008 ○ 430 m ²			
WAAMB311 ○ 500 m ²	WAAMB301 ○ 500 m ²					
WAAMB312 ○ 500 m ²	WAAMB302 ○ 500 m ²					
WAAMB313 ○ 500 m ²	WAAMB303 ○ 500 m ²					
WAAMB681 ○ 500 m ²	WAAMB671 ○ 500 m ²					
logistische Daten logistic information						
	20				18	
	12,5				12,0	
	1,60				1,50	
	48				54	
	76,80				81,00	
	20,6				18,6	
	12,9				12,4	
	1 016				1 030	



Produkt product	□				□		□	
EN 14411 - L BIII	Wandfliese wall tile				Wandfliese wall tile		Wandfliese wall tile	
	20x25				20x20		15x20	
	198x248x6,8				198x198x6,5		148x198x6	
Oberfläche surface	matt	glänzend glossy	relief matt gewellt wave	relief glänzend glossy gewellt wave	matt	glänzend glossy	matt	glänzend glossy
Farbe color								
RAL 0001500 schwarz black					WAA1N732 ○ 450 m ²	WAA1N779 ○ 450 m ²		
RAL 0004000 anthrazit-grau anthracite-grey					WAA1N765 ○ 450 m ²	WAA1N755 ○ 450 m ²		
RAL 0805005 dunkelgrau dark grey					WAA1N111 ○ 450 m ²	WAA1N011 ○ 450 m ²		
RAL 0607005 grau grey					WAA1N210 ○ 370 m ²	WAA1N010 ○ 370 m ²		
RAL 0008500 hellgrau light grey					WAA1N112 ○ 370 m ²	WAA1N012 ○ 370 m ²		
WHITE weiß white	WAAG6104 ○ 360 m ²	WAAG6000 ○ 360 m ²	WARG6104 ○ 370 m ²	WARG6000 ○ 370 m ²	WAA1N104 ○ 350 m ²	WAA1N000 ○ 350 m ²	WAADP104 ○ 380 m ²	WAADP000 ○ 380 m ²
RAL 0709010 hellbeige light beige					WAA1N107 ○ 370 m ²	WAA1N007 ○ 370 m ²		
RAL 0508010 beige beige					WAA1N108 ○ 370 m ²	WAA1N008 ○ 370 m ²		
RAL 0607020 dunkelbeige dark beige					WAA1N311 ○ 450 m ²	WAA1N301 ○ 450 m ²		
RAL0607010 beige-grau beige-grey					WAA1N312 ○ 450 m ²	WAA1N302 ○ 450 m ²		
RAL 0805010 grau-beige grey-beige					WAA1N313 ○ 450 m ²	WAA1N303 ○ 450 m ²		
RAL 0502010 dunkelbraun dark brown					WAA1N681 ○ 450 m ²	WAA1N671 ○ 450 m ²		

logistische Daten logistic information			
	30		25 25
	20,0		25,0 25,0
	1,50		1,00 1,00
	60		84 104
	90,00		84,00 104,00
	17,6		11,2 11,2
	11,7		11,2 11,2
	1 078		966 1 190

□	□		
Wandfliese wall tile	Wandfliese überglasierte Kante wall tile overglazed edge		
15x15	148x148x6		
matt	glänzend glossy	matt	glänzend glossy
WAA19732 ○ 390 m ²	WAA19779 ○ 390 m ²		
WAA19765 ○ 390 m ²	WAA19755 ○ 390 m ²		
WAA19111 ○ 390 m ²	WAA19011 ○ 390 m ²		
WAA19210 ○ 360 m ²	WAA19010 ○ 360 m ²		
WAA19112 ○ 360 m ²	WAA19012 ○ 360 m ²		
WAA19104 ○ 350 m ²	WAA19000 ○ 350 m ²	WAE19104 ○ 330 m ²	WAE19000 ○ 330 m ²
WAA19107 ○ 360 m ²	WAA19007 ○ 360 m ²		
WAA19108 ○ 360 m ²	WAA19008 ○ 360 m ²		
WAA19311 ○ 390 m ²	WAA19301 ○ 390 m ²		
WAA19312 ○ 390 m ²	WAA19302 ○ 390 m ²		
WAA19313 ○ 390 m ²	WAA19303 ○ 390 m ²		
WAA19681 ○ 390 m ²	WAA19671 ○ 390 m ²		

		44	
		44,0	
		1,00	
		100	
		100,00	
		10,0	
		10,0	
		1 025	



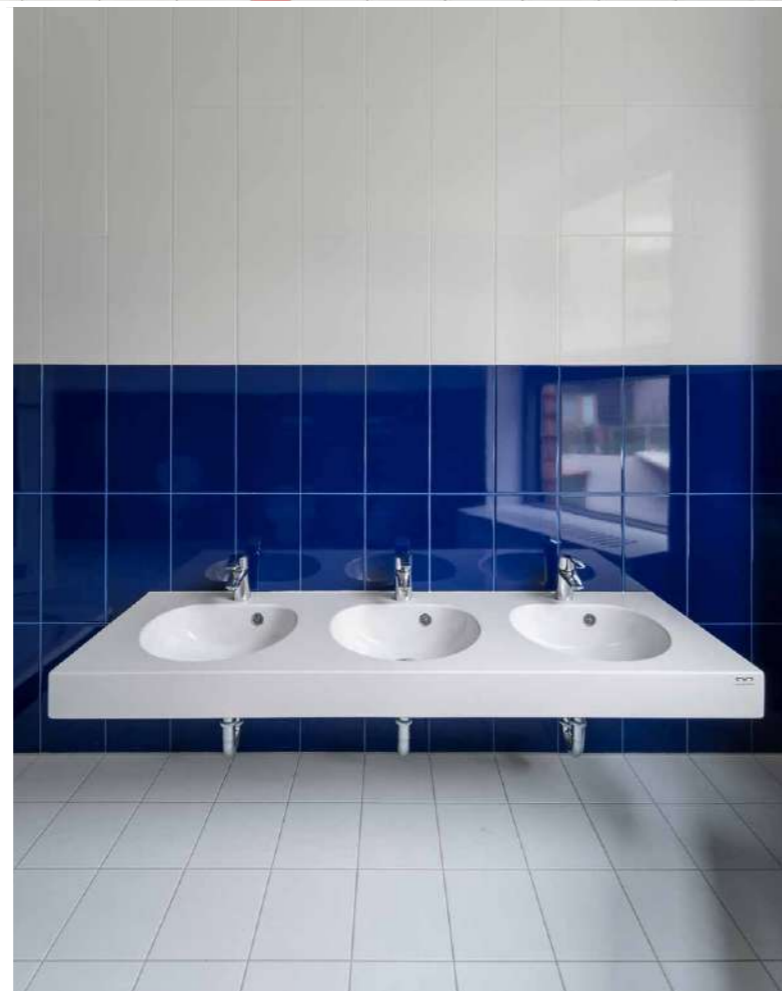

Produkt product						
EN 14411 - L B III	Wandfliese wall tile	Wandfliese wall tile	Wandfliese wall tile			
	20x40	20x20	15x15			
	198x398x7	198x198x6,5	148x148x6			
Oberfläche surface	matt	glänzend glossy	matt	glänzend glossy	matt	glänzend glossy
Farbe color						
RAL 0304060 rot red	WAAMB373 ○ 680 m ²	WAAMB363 ○ 680 m ²	WAA1N373 ○ 530 m ²	WAA1N363 ○ 530 m ²	WAA19373 ○ 590 m ²	WAA19363 ○ 590 m ²
RAL 0506080 orange orange	WAAMB460 ○ 680 m ²	WAAMB450 ○ 680 m ²	WAA1N460 ○ 530 m ²	WAA1N450 ○ 530 m ²	WAA19460 ○ 590 m ²	WAA19450 ○ 590 m ²
RAL 0607050 hellorange light orange	WAAMB282 ○ 530 m ²	WAAMB272 ○ 530 m ²	WAA1N282 ○ 480 m ²	WAA1N272 ○ 480 m ²	WAA19282 ○ 440 m ²	WAA19272 ○ 440 m ²
RAL 0858070 dunkelgelb dark yellow	WAAMB222 ○ 530 m ²	WAAMB201 ○ 530 m ²	WAA1N222 ○ 480 m ²	WAA1N201 ○ 480 m ²	WAA19222 ○ 440 m ²	WAA19201 ○ 440 m ²
RAL 0908040 gelb yellow	WAAMB221 ○ 530 m ²	WAAMB200 ○ 530 m ²	WAA1N221 ○ 480 m ²	WAA1N200 ○ 480 m ²	WAA19221 ○ 440 m ²	WAA19200 ○ 440 m ²
RAL 0958070 gelb-grün yellow-green	WAAMB464 ○ 530 m ²	WAAMB454 ○ 530 m ²	WAA1N464 ○ 480 m ²	WAA1N454 ○ 480 m ²	WAA19464 ○ 440 m ²	WAA19454 ○ 440 m ²
RAL 1208050 hellgrün light green	WAAMB465 ○ 530 m ²	WAAMB455 ○ 530 m ²	WAA1N465 ○ 480 m ²	WAA1N455 ○ 480 m ²	WAA19465 ○ 440 m ²	WAA19455 ○ 440 m ²
RAL 1306050 grün green	WAAMB466 ○ 530 m ²	WAAMB456 ○ 530 m ²	WAA1N466 ○ 480 m ²	WAA1N456 ○ 480 m ²	WAA19466 ○ 440 m ²	WAA19456 ○ 440 m ²
RAL 1907025 türkis turquoise	WAAMB467 ○ 530 m ²	WAAMB457 ○ 530 m ²	WAA1N467 ○ 480 m ²	WAA1N457 ○ 480 m ²	WAA19467 ○ 440 m ²	WAA19457 ○ 440 m ²
RAL 2408015 hellblau light blue	WAAMB540 ○ 530 m ²	WAAMB550 ○ 530 m ²	WAA1N540 ○ 480 m ²	WAA1N550 ○ 480 m ²	WAA19540 ○ 440 m ²	WAA19550 ○ 440 m ²
RAL 2606025 blau blue	WAAMB541 ○ 530 m ²	WAAMB551 ○ 530 m ²	WAA1N541 ○ 480 m ²	WAA1N551 ○ 480 m ²	WAA19541 ○ 440 m ²	WAA19551 ○ 440 m ²
RAL 2902035 dunkelblau dark blue	WAAMB545 ○ 680 m ²	WAAMB555 ○ 680 m ²	WAA1N545 ○ 530 m ²	WAA1N555 ○ 530 m ²	WAA19545 ○ 590 m ²	WAA19555 ○ 590 m ²
logistische Daten logistic information						
	20	25 25	44			
	12,5	25,0 25,0	44,0			
	1,60	1,00 1,00	1,00			
	48	84 104	100			
	76,80	84,00 104,00	100,00			
	20,6	11,2 11,2	10,0			
	12,9	11,2 11,2	10,0			
	1 016	966 1 190	1 025			



RAL 0001500
schwarz | black



RAL 0004000
anthrazit-grau | anthracite-grey



RAL 0805005
dunkelgrau | dark grey

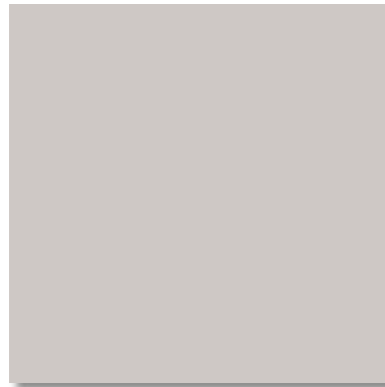

RAL 0607005
grau | grey

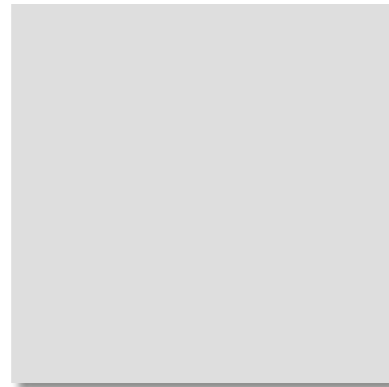

RAL 0008500
hellgrau | light grey



WHITE
weiß | white

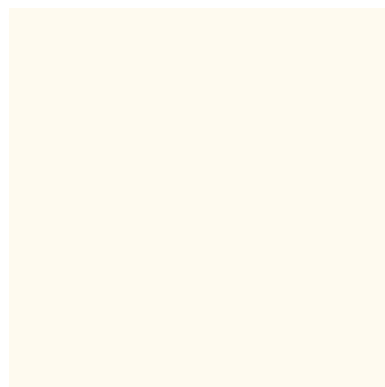

RAL 0709010
hellbeige | light beige

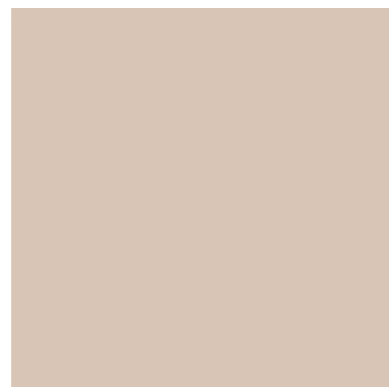

RAL 0508010
beige | beige



RAL 0607020
dunkelbeige | dark beige

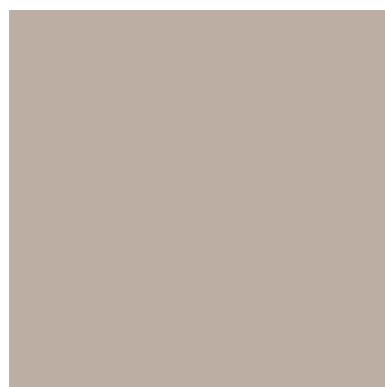

RAL 0607010
beige-grau | beige-grey



RAL 0805010
grau-beige | grey-beige

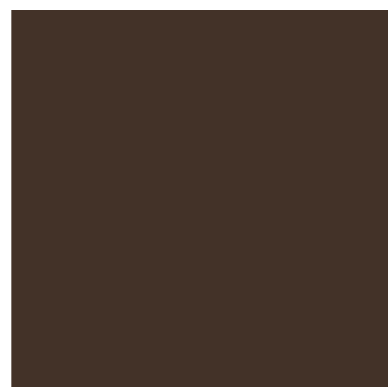

RAL 0502010
dunkelbraun | dark brown



RAL 0304060
rot | red



RAL 0506080
orange | orange



RAL 0607050
hellorange | light orange



RAL 0858070
dunkelgelb | dark yellow

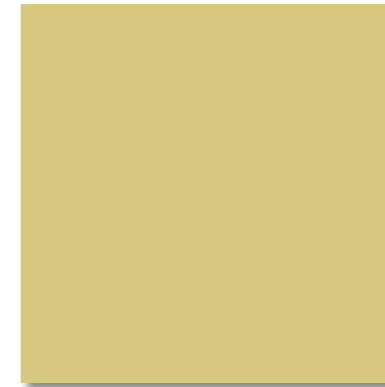

RAL 0908040
gelb | yellow



RAL 0958070
gelb-grün | yellow-green



RAL 1208050
hellgrün | light green



RAL 1306050
grün | green

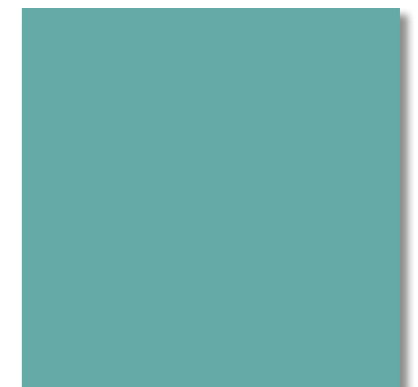

RAL 1907025
türkis | turquoise

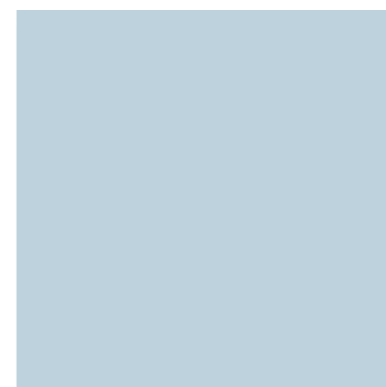

RAL 2408015
hellblau | light blue



RAL 2606025
blau | blue

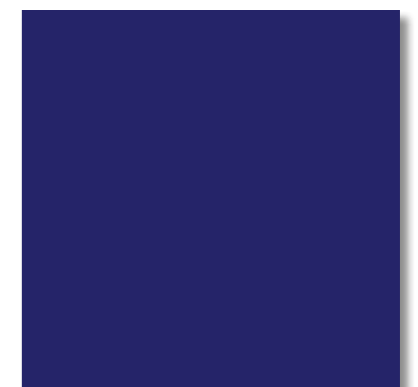

RAL 2902035
dunkelblau | dark blue



Oberflächen | surfaces

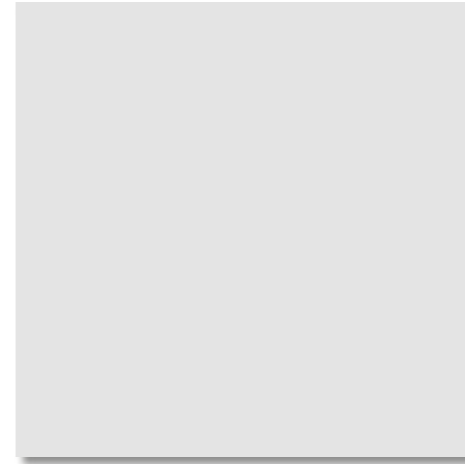

matt



glänzend | glossy

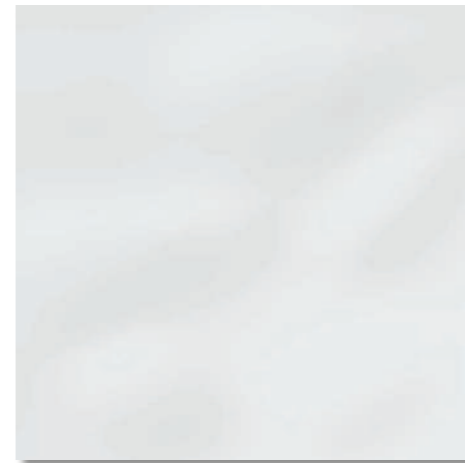

gewellt | wave



geschpachtelt | spattle

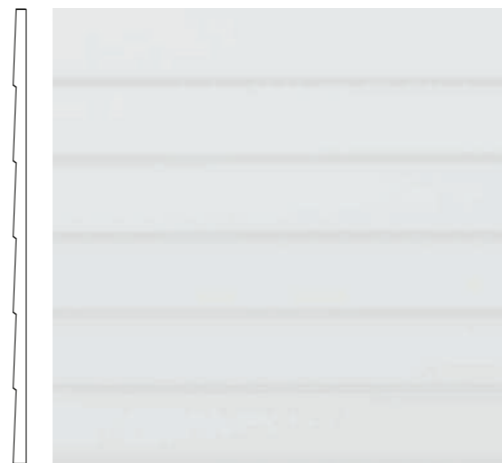

Lamelle | lamella



Penta



Bob und Bobek

Warum Bob und Bobek auf Fliesen? Sowohl RAKO als auch Bob und Bobby, die Kaninchen aus dem Hut, stehen für neue Erfahrungen, innovative Ideen und Spaß für kommende Generationen. Die Wandfliesen mit Kindermotiven im Format 20 × 40 cm in schwarzweißer Ausführung können in Verbindung mit der Serie ColorONE sowohl im privaten als auch im öffentlichen Sektor verwendet werden.

„Aktiv jeden Tag!“



RAKO Object



Bob and Bobek

Why Bob and Bobek on tiles? RAKO and the Rabbits from the Hat share their new experiences, innovative ideas, and fun for generations. The 20 × 40 cm wall tiles with children's themes in black and white design with a link to the ColorONE series can be used in both the private and public sectors.

„Get active every day!“





Wandfliese | wall tile | **WADMB210*** | 198x398x7 mm

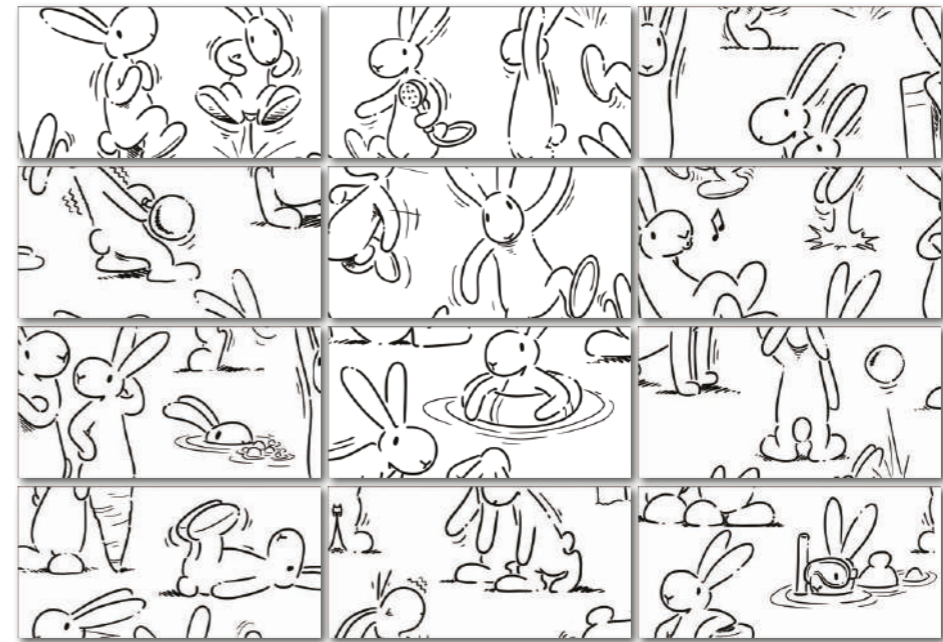

○ 680 l m²
glänzend | glossy
weiß | white

*Das Produkt zeigt die individuellen Designmöglichkeiten auf in jeder Verpackung. | The products are deliberately mixed in packing to include a random selection of designs.

Decor | decor | **WIDMB210** | 198x398x7 mm

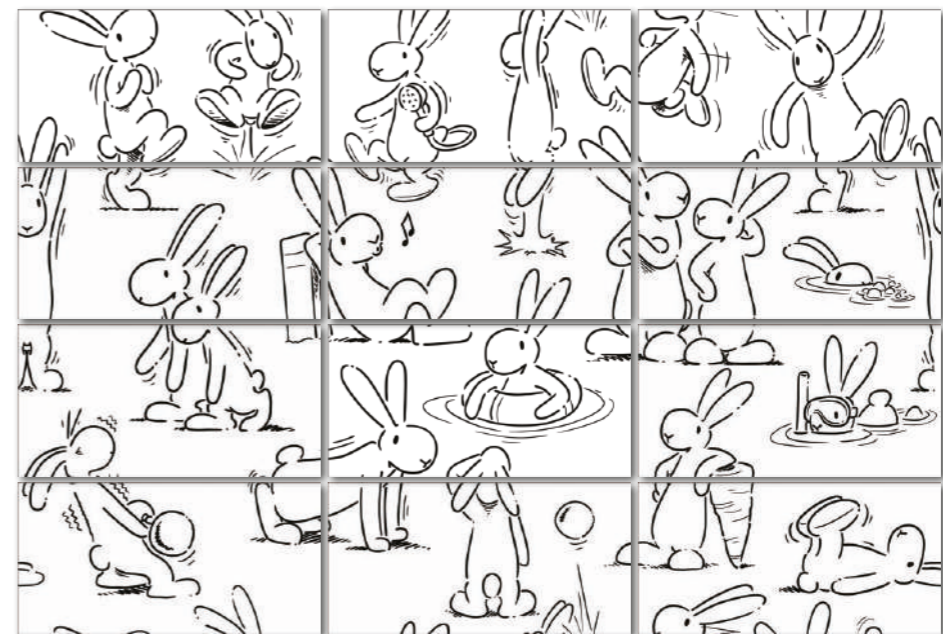

○ 920 l set
glänzend | glossy
weiß | white

(SET)

Produkt | product



Wandfliese wall tile	20x40	198x398x7	EN 14411 - L BIII	20	12,5	1,60	48	76,80	20,6	12,9	1 016
Decor 1 set/12 St decor 1 set/12 pcs	20x40	198x398x7	EN 14411 - L BIII	1	-	-	-	-	-	12,9	-



20x40
v4

20x40
v3



Die komplette Serie glasierter Feinsteinzeug-Bodenfliesen, die mit dem Farbspektrum der Wandfliesen ColorONE verbunden ist, bietet sich perfekt für Projektlösungen und unkonventionelle Anwendungen an. Viele Modulformate und ein vielfältiges Angebot an funktionalem Zubehör ermöglichen die Kombination verschiedener Grundelemente und eine optimale Kompatibilität mit den Wandfliesen der ColorONE-Serie.

„Einzigartige Farbkombinationen.“



A comprehensive series of sintered glazed tiles ColorTWO systemically linked to the ColorONE colour spectrum invites you to overall project solutions and unconventional applications. The modular formats and a wide range of functional supplies allow different basic elements to be combined with each other and to achieve optimum compatibility with the ColorONE wall tile series.

„Unique color combinations.“



















Produkt product									
EN 14411 - G B1a	Bodenfliese floor tile	Bodenfliese floor tile	Bodenfliese floor tile	Bodenfliese floor tile	Bodenfliese floor tile				
	30x60 R	30x30	20x20	10x30	10x20				
	298x598x10* 298x598x9**	298x298x8	198x198x7	98x298x8	98x198x7				
Oberfläche surface	matt ABS	matt	matt	matt GAF	relief matt GRS	matt	glänzend glossy	matt	relief matt GRN
Rutschfestigkeit slip resistance	R10/B			R10/B	R10/B				R10/B
Reibungskoeffizient - trocken sliding friction coefficient - dry	$\mu \geq 0,6$	$\mu \geq 0,5$	$\mu \geq 0,5$	$\mu \geq 0,6$	$\mu \geq 0,6$	$\mu \geq 0,5$		$\mu \geq 0,5$	$\mu \geq 0,6$
Farbe color									
RAL 0001500 schwarz black			GAA1K048 ○ 500 m ²						
RAL 0004000 anthrazit-grau anthracite grey			GAA1K248 ○ 500 m ²	GAF1K248 ○ 550 m ²	GRS1K248 ○ 550 m ²	GAAJD248 ○ 670 m ²			
RAL 0805005 dunkelgrau dark grey			GAA1K111 ○ 500 m ²						
RAL 0607005 grau grey			GAA1K110 ○ 470 m ²	GAF1K610 ○ 510 m ²	GRS1K610 ○ 510 m ²	GAAJD110 ○ 670 m ²		GAAD8110 ○ 650 m ²	
RAL 0008500 hellgrau light grey			GAA1K112 ○ 470 m ²	GAF1K612 ○ 510 m ²	GRS1K612 ○ 510 m ²	GAAJD112 ○ 670 m ²			
WHITE weiß white	GAkse023* GAKSR023** ○ 650 m ²	GAAZJ023 ○ 470 m ²	GAA1K023 ○ 450 m ²	GAF1K023 ○ 500 m ²	GRS1K623 ○ 500 m ²	GAAJD023 ○ 650 m ²	GAAJD052 ○ 650 m ²	GAAD8023 ○ 640 m ²	GRND8023 ○ 690 m ²
RAL 0709010 hellbeige light beige			GAA1K107 ○ 470 m ²		GRS1K607 ○ 510 m ²	GAAJD107 ○ 670 m ²			
RAL 0508010 beige beige			GAA1K108 ○ 470 m ²		GRS1K608 ○ 510 m ²	GAAJD108 ○ 670 m ²		GAAD8108 ○ 650 m ²	
RAL 0607020 dunkelbeige dark beige			GAA1K311 ○ 500 m ²						
RAL0607010 beige-grau beige-grey			GAA1K312 ○ 500 m ²						
RAL 0805010 grau-beige grey-beige			GAA1K313 ○ 500 m ²						
RAL 0502010 dunkelbraun dark brown			GAA1K671 ○ 500 m ²						
logistische Daten logistic information									
	6 7	13		25		24		35	
	5,6 5,6	11,0		25,0		33,3		50,0	
	1,08 1,26	1,18		1,00		0,72		0,70	
	40 40	48		72		66		90	
	43,2 50,40	56,64		72,00		47,52		63,00	
	23,7 24,2	20,5		15,5		12,5		10,5	
	21,9 19,2	17,4		15,5		17,3		15,0	
	971 993	1 011		1 141		851		971	





Bodenfliese floor tile mosaic sheet 30x30 cm					Mosaik sheet 30x30 cm mosaic sheet 30x30 cm			Mosaik sheet 30x30 cm mosaic sheet 30x30 cm	
10x10					5x5			2,5x2,5	
98x98x6					48x48x6			48x48x7 R	
matt					glänzend glossy			matt	
					matt GAF			relief matt GRS	
					R10/B			R10/B	
$\mu \geq 0,5$					$\mu \geq 0,6$			$\mu \geq 0,6$	
								C	
GAAOK048 ○ 820 m ²					GAAOK548 ○ 820 m ²				
GAAOK248 ○ 820 m ²					GAFOK248 ○ 860 m ²			GRSOK248 ○ 860 m ²	
GAAOK111 ○ 820 m ²									
GAAOK110 ○ 800 m ²					GAFOK610 ○ 830 m ²			GRSOK610 ○ 830 m ²	
					GDM05110 ○ 850 m ²			GRS05610 ○ 1590 m ²	
					GDM02110 ○ 920 m ²				
GAAOK112 ○ 800 m ²					GAFOK612 ○ 830 m ²			GRSOK612 ○ 830 m ²	
					GDM05112 ○ 850 m ²			GRS05612 ○ 1590 m ²	
					GDM02112 ○ 920 m ²				
GAAOK023 ○ 750 m ²					GAAOK052 ○ 750 m ²			GAFOK023 ○ 800 m ²	
					GRSOK623 ○ 800 m ²			GRHOK223 ○ 790 m ²	
					GDM05023 ○ 810 m ²			GDM05052 ○ 830 m ²	
					GRS05623 ○ 1590 m ²			GDM02023 ○ 900 m ²	
					GDM02052 ○ 900 m ²				
GAAOK107 ○ 800 m ²								GRSOK607 ○ 830 m ²	
					GDM05107 ○ 850 m ²			GRS05607 ○ 1590 m ²	
					GDM02107 ○ 920 m ²				
GAAOK108 ○ 800 m ²								GRSOK608 ○ 830 m ²	
					GDM05108 ○ 850 m ²			GRS05608 ○ 1590 m ²	
					GDM02108 ○ 920 m ²				
GAAOK311 ○ 820 m ²									
GAAOK312 ○ 820 m ²									
GAAOK313 ○ 820 m ²									
					11			11	
					11,0			11,0	
					1,00			1,00	
					60			60	
					60,00			60,00	
					12,9			12,9	
					12,9			12,9	
					799			799	

* Verfügbar solange der Vorrat reicht | Available while stocks last

** Neues Produkt in 9 mm Stärke im Laufe des Jahres 2025 verfügbar | New product in 9 mm thickness available during 2025



Produkt product	 Hohlkehlsymbol cove skirting	 Hohlkehlsymbol cove skirting	 Innenecke Hohlkehlsymbol inside corner cove skirting	 Außenecke Hohlkehlsymbol outside corner cove skirting	 Innenkante inside edge	
STO No. 030 - 059824						
 20x20	20x20	20x20	2,4x20	3x20	2,4x20	
 198x204x7	198x204x7	198x204x7	24x204x7	30x204x7	24x198x7	
Oberfläche surface	relief matt GRS	matt	matt	matt	matt	matt GAF
Rutschfestigkeit slip resistance	R10/B					R10/B
Reibungskoeffizient - trocken sliding friction coefficient - dry	$\mu \geq 0,6$					$\mu \geq 0,6$
Farbe color						
RAL 0004000 anthrazit-grau anthracite grey	GST1K248 ○ 200 St	GSP1K248 ○ 160 St	GSIRI248 ○ 220 St	GSEIR248 ○ 220 St	GSIAP248 ○ 220 St	
RAL 0607005 grau grey	GST1K110 ○ 200 St	GSP1K110 ○ 160 St	GSIRI110 ○ 220 St	GSEIR110 ○ 220 St	GSIAP110 ○ 220 St	
RAL 0008500 hellgrau light grey	GST1K112 ○ 200 St	GSP1K112 ○ 160 St	GSIRI112 ○ 220 St	GSEIR112 ○ 220 St	GSIAP112 ○ 220 St	
WHITE weiß white	GST1K023 ○ 200 St	GSP1K023 ○ 160 St	GSIRI023 ○ 220 St	GSEIR023 ○ 220 St	GSIAP023 ○ 220 St	GSIAPF23 ○ 220 St
RAL 0709010 hellbeige light beige	GST1K107 ○ 200 St	GSP1K107 ○ 160 St	GSIRI107 ○ 220 St	GSEIR107 ○ 220 St	GSIAP107 ○ 220 St	
RAL 0508010 beige beige	GST1K108 ○ 200 St	GSP1K108 ○ 160 St	GSIRI108 ○ 220 St	GSEIR108 ○ 220 St	GSIAP108 ○ 220 St	
RAL 2408015 hellblau light blue	GST1K003 ○ 200 St	GSP1K003 ○ 160 St	GSIRI003 ○ 220 St	GSEIR003 ○ 220 St	GSIAP003 ○ 220 St	GSIAPF03 ○ 220 St
RAL 2902035 dunkelblau dark blue	GST1K005 ○ 200 St	GSP1K005 ○ 160 St	GSIRI005 ○ 220 St	GSEIR005 ○ 220 St	GSIAP005 ○ 220 St	GSIAPF05 ○ 220 St
logistische Daten logistic information						
	28	28	24	24	24	
	-	-	-	-	-	
	-	-	-	-	-	
	-	-	-	-	-	
	17,6	17,6	3,1	3,6	3,1	
	-	-	-	-	-	
	-	-	-	-	-	

 Außenkante outside edge	 Außenecke outside corner	 Duschasseneckstein shower piece corner	 Duschassenstein shower piece continuous
2,4x20	2,4x2,4	10x10	10x10
24x198x7	24x24x24	98x98x6	98x98x6
matt	matt GAF	matt	matt GAF
	R10/B		R10/B
	$\mu \geq 0,6$		$\mu \geq 0,6$
GSEAP248 ○ 220 St		GTVR4248 ○ 300 St	GTRON248 ○ 240 St
GSEAP110 ○ 220 St		GTVR4110 ○ 300 St	GTRON610 ○ 200 St
GSEAP112 ○ 220 St		GTVR4112 ○ 300 St	GTRON612 ○ 200 St
GSEAP023 ○ 220 St	GSEAPF23 ○ 220 St	GTVR4023 ○ 300 St	GTVR4F23 ○ 300 St
GSEAP107 ○ 220 St		GTVR4107 ○ 300 St	GTRON607 ○ 200 St
GSEAP108 ○ 220 St		GTVR4108 ○ 300 St	GTRON608 ○ 200 St
GSEAP003 ○ 220 St	GSEAPF03 ○ 220 St	GTVR4003 ○ 300 St	GTVR4F03 ○ 300 St
GSEAP005 ○ 220 St	GSEAPF05 ○ 220 St	GTVR4005 ○ 300 St	GTVR4F05 ○ 300 St
		GTRON605 ○ 240 St	GTPON605 ○ 240 St
	24	50	18
	-	-	100,0
	-	-	0,18
	-	-	-
	-	-	-
	3,1	0,9	3,3
	-	-	-
	-	-	-

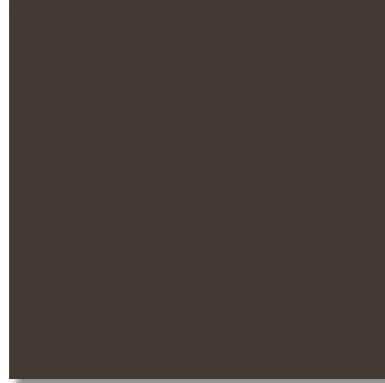

RAL 0001500 PEI 2
schwarz | black

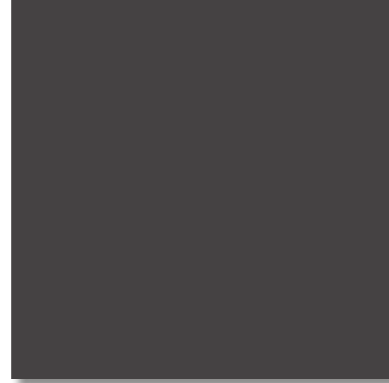

RAL 0004000 PEI 2
anthrazit-grau | anthracite-grey



RAL 0805005 PEI 3
dunkelgrau | dark grey

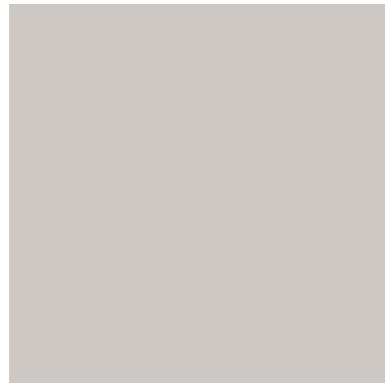

RAL 0607005 PEI 4
grau | grey

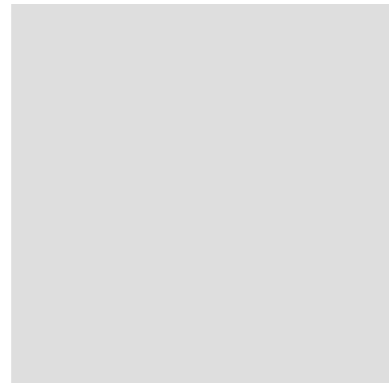

RAL 0008500 PEI 4
hellgrau | light grey



WHITE PEI 4 (matt)
weiß | white PEI 2 (glänzend | glossy)
GAKSE023 PEI 5 (matt)

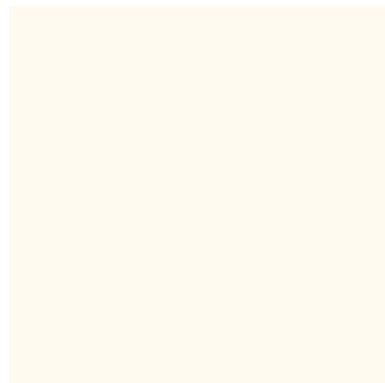

RAL 0709010 PEI 4
hellbeige | light beige

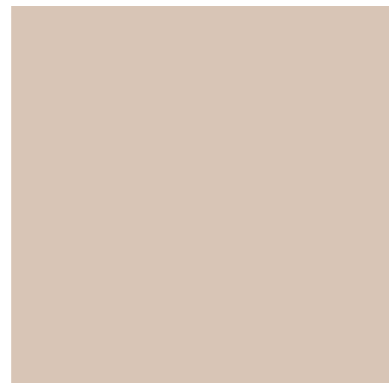

RAL 0508010 PEI 4
beige | beige



RAL 0607020 PEI 3
dunkelbeige | dark beige

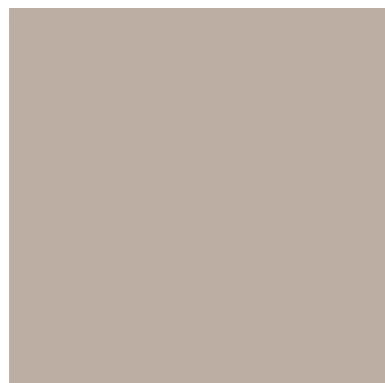

RAL 0607010 PEI 3
beige-grau | beige-grey

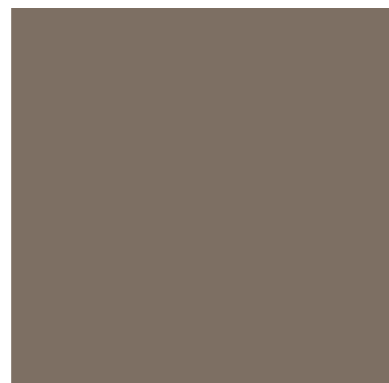

RAL 0805010 PEI 3
grau-beige | grey-beige

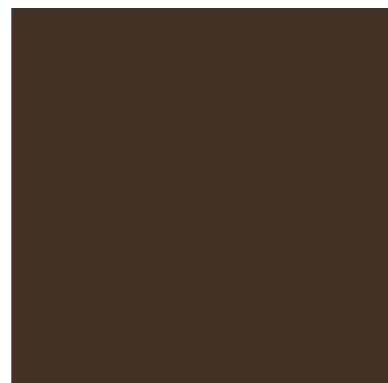

RAL 0502010 PEI 2
dunkelbraun | dark brown



RAL 0304060 PEI 2
rot | red



RAL 0506080 PEI 3
orange | orange



RAL 0607050 PEI 3
hellorange | light orange



RAL 0858070 PEI 3
dunkelgelb | dark yellow



RAL 0908040 PEI 4
gelb | yellow



RAL 0958070 PEI 4
gelb-grün | yellow-green

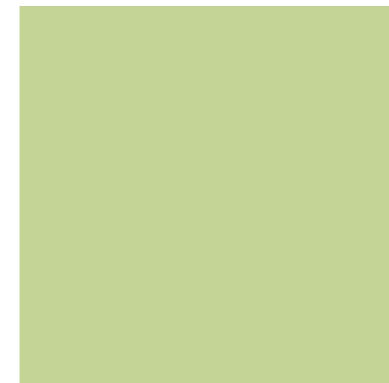

RAL 1208050 PEI 4
hellgrün | light green



RAL 1306050 PEI 3
grün | green



RAL 1907025 PEI 3
türkis | turquoise



RAL 2408015 PEI 4
hellblau | light blue



RAL 2606025 PEI 4
blau | blue



RAL 2902035 PEI 3
dunkelblau | dark blue



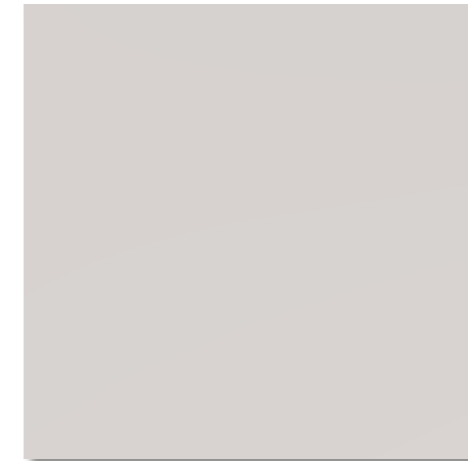
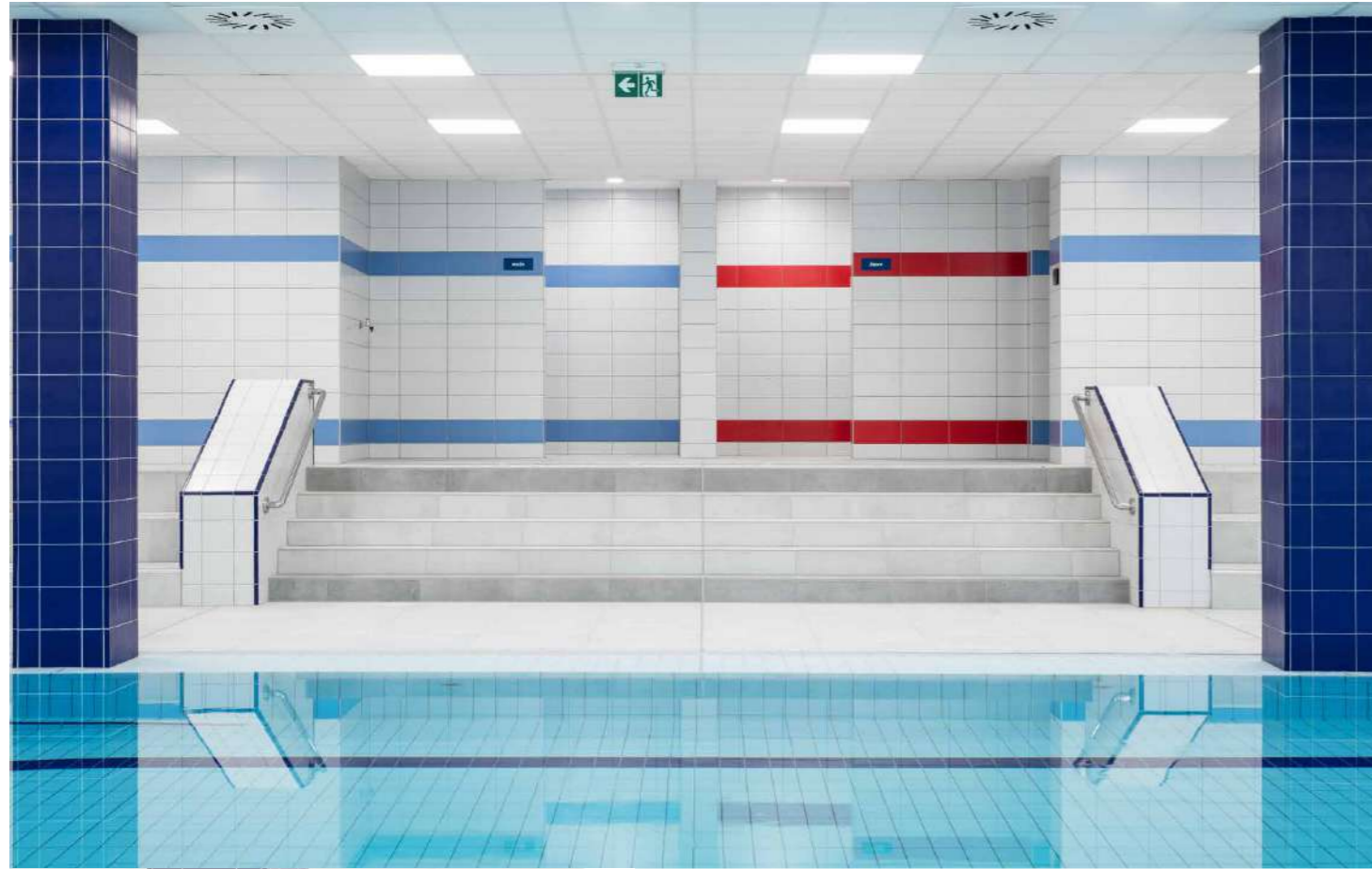

matt $\mu \geq 0,5$
ABS R10/B $\mu \geq 0,6$

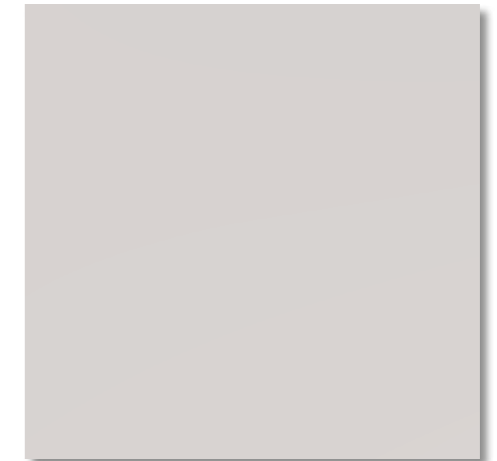

glänzend | glossy



matt GAF R10/B $\mu \geq 0,6$



relief GRN R10/B $\mu \geq 0,6$



relief GRS R10/B $\mu \geq 0,6$



relief GRH $\mu \geq 0,7$

GAF... - Glatte Rutschhemmende Oberfläche | Smooth Slip-resistant surface
GR... - Reliefoberfläche | Relief surface
ABS... - Rutschhemmende Oberfläche R10/B | Slip-resistant surface R10/B



Formteile | special pieces

Hohlkehlsoclel | cove skirting | **GST1K...** | 198x204x7 mm

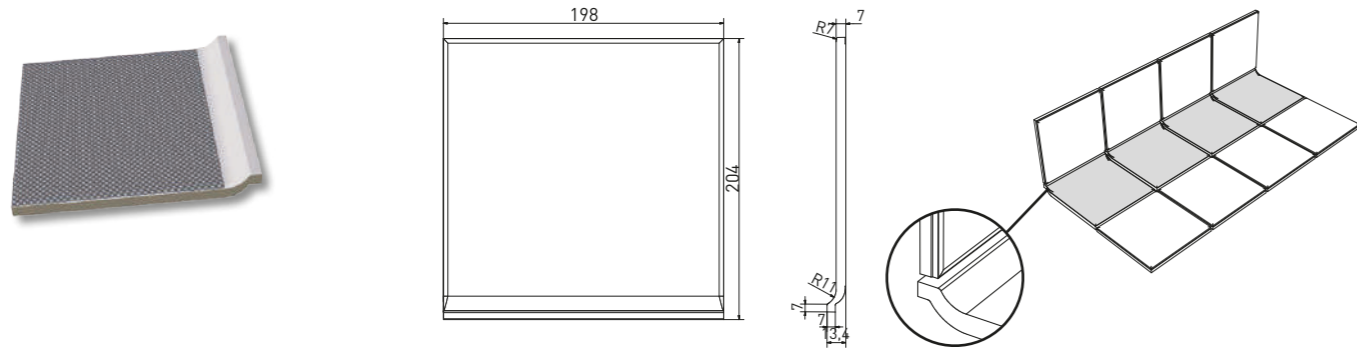

Hohlkehlsoclel | cove skirting | **GSP1K...** | 198x204x7 mm

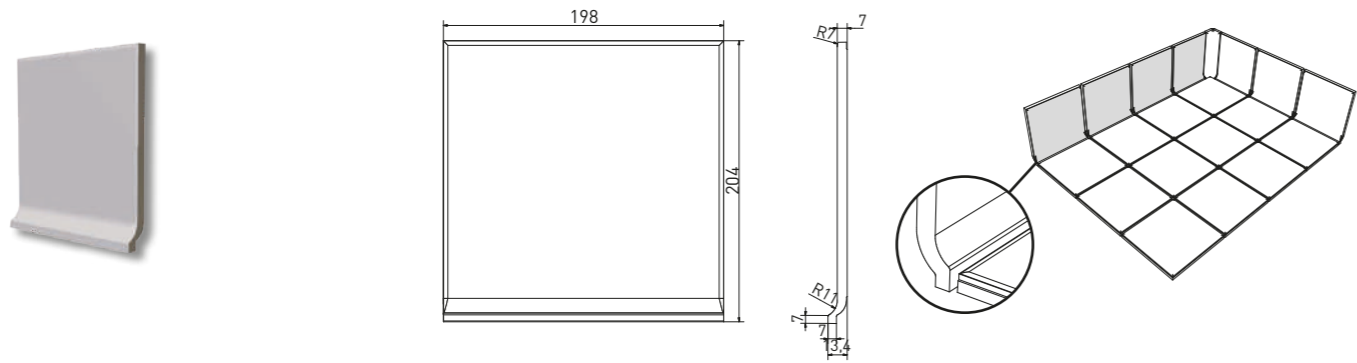

Innenecke Hohlkehlsoclel | inside corner cove skirting | **GSIRI...** | 24x204x7 mm

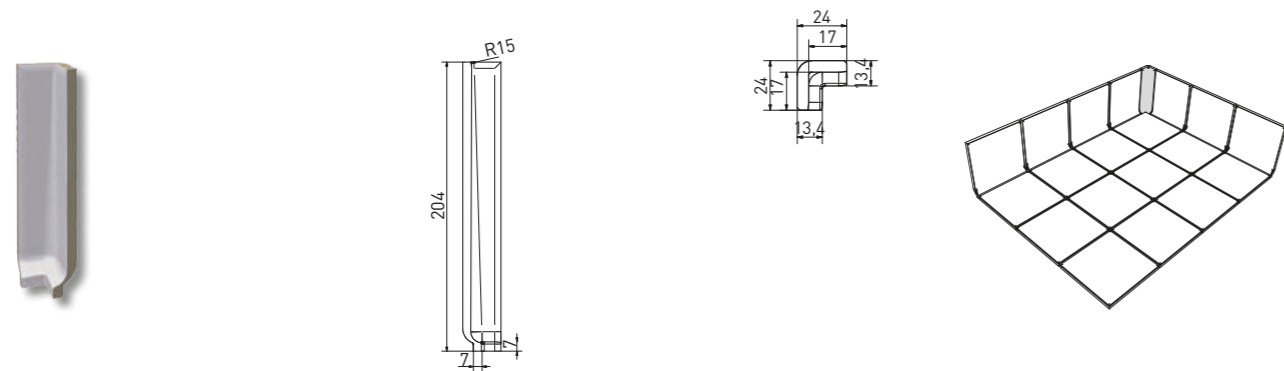

Außenecke Hohlkehlsoclel | outside corner cove skirting | **GSERI...** | 30x204x7 mm

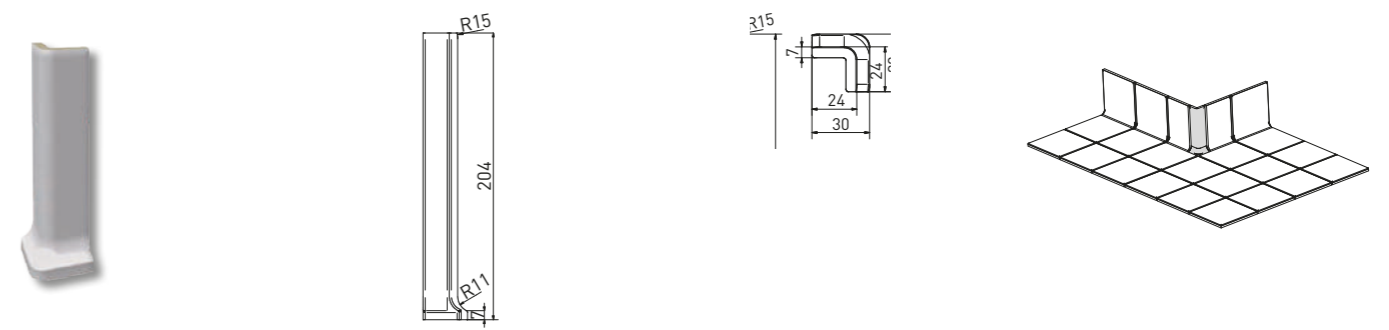

Innenkante | inside edge - shower piece | **GSIAF...** | **GSIAF...** | 24x198x7 mm

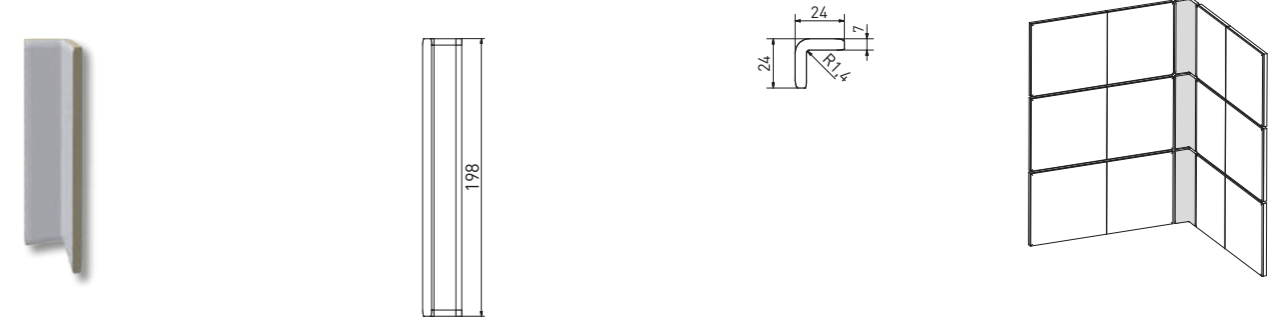

Außenkante | outside edge - shower piece | **GSEAF...** | **GSEAF...** | 24x198x7 mm

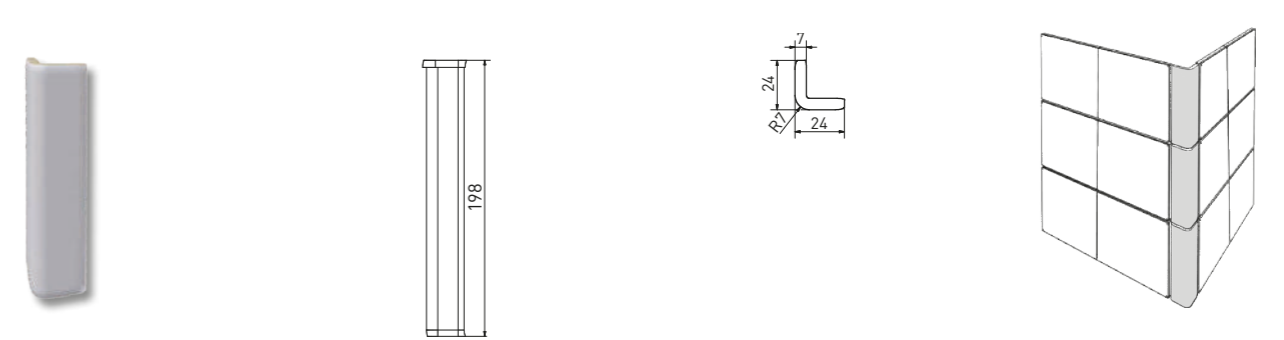



Außenecke | outside corner | **GTVR4...** | **GTVR4F...** | 24×24×24 mm

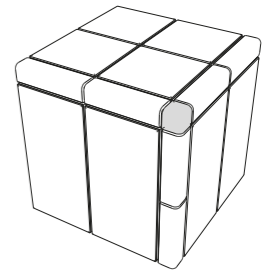
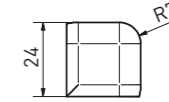
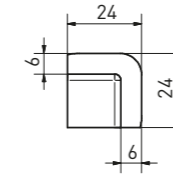

Duschtasseneckstein | shower piece - corner | **GTRON...** | 98×98×6 mm

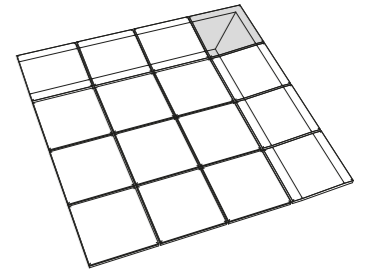
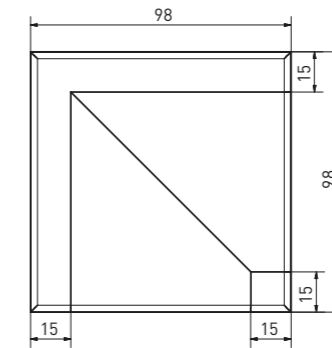
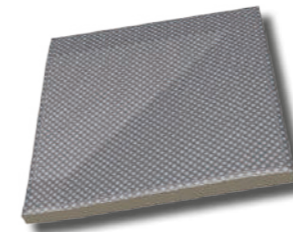

Duschtassenstein | shower piece - continuous | **GTPON...** | 98×98×6 mm

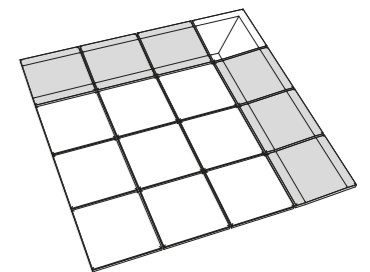
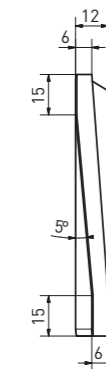
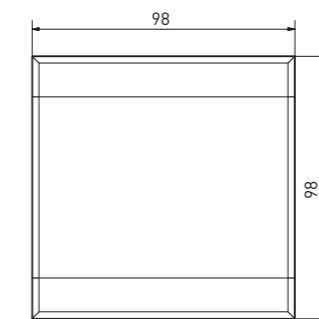
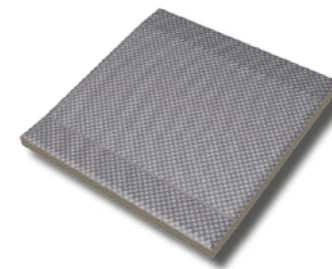



Die Serie POOL bietet umfassende Lösungen für Außen- und Innenschwimmbecken sowie einen durchdachten Funktionsaufbau der Produkte. Sie bietet zudem auch verschiedenste Formstücke nicht nur für Schwimmbecken, sondern auch für technische Anlagen und die angrenzenden Bereiche. Das Sortiment basiert sowohl im Format als auch in der Farbe auf der Serie ColorTWO. Die rutschhemmenden Oberflächen entsprechen den festgelegten Eigenschaften der Normen und Vorschriften.

„Poolkollektion mit Fokus aufs Detail.“



The POOL series offers a comprehensive solution for outdoor and indoor swimming pools, a sophisticated functional product mix including shape-intensive supplies not only for swimming pools but for technical facilities and their adjacent areas as well. The assortment follows the basic ColorTWO product range. The anti-slip surfaces meet the properties defined by standards and regulations.

„Pool collection focused on the detail.“





Produkt | product



STO No. 030 - 059824





	Beckenrandstein Zürich edging tile Zürich	Handfaßstein Finnland hand grip piece Finland	Innenecke Finnland (Set 2 St) inside corner Finland (set 2 pcs)	Außenecke Finnland (Set 2 St) outside corner Finland (set 2 pcs)	Muldenrinne gutter tile	
	20×11,5	19,7×11,5	19,7×11,5	11,2×11,2	23,8×11,5	19,7×15
	198×115×10/21	197×115×15/45	197×115×15/25	(2×) 112×112×15/25	(2×) 238×115×15/25	197×150×35
Oberfläche surface	matt	matt	matt	matt	matt	matt
Rutschfestigkeit slip resistance		♣C	♣C	♣C	♣C	♣C
Reibungskoeffizient - bei Nässe sliding friction coefficient - wet		μ ≥ 0,6	μ ≥ 0,6	μ ≥ 0,6	μ ≥ 0,6	μ ≥ 0,6
Farbe color						
WHITE weiß white	GTVDA013 ○ 270 St					XPP58023 ○ 500 St
RAL2408015 hellblau light blue	GTVDA003 ○ 270 St					
RAL 2902035 dunkelblau dark blue	GTVDA005 ○ 270 St					
WHITE weiß white		XPP55005 ○ 780 St	XPP56005 ○ 530 St	XPI56005 ○ 830 Set	XPA56005 ○ 1110 Set	
RAL 2902035 dunkelblau dark blue						XPP57005 ○ 530 St
logistische Daten logistic information						
	20	10	14	1 Set	1 Set	16
	5	5	5	-	-	5
	8,5	10,5	13,3	0,7	1,7	12,0









Stück-Anzahl pro laufenden Meter. | Number of pcs per linear metre.

Muldenrinne Ablauf gutter tile - outlet	Muldenrinne Endstück gutter tile - end	Muldenrinne Ecke (Set 2 St) gutter tile - corner (set 2 pcs)	Rillenplatte step tile flat	Rillenplatte - signal Längsrundung step tile-signal radius	Treppenwinkel - signal Kante step tile-signal edge
19,7×15	19,7×15	19,7×15	19,7×15	19,7×15	19,7×11,5
197×150×35	197×150×35	(2x) 197×150×35	197×150×10	197×150×10	197×115×10/52
matt	matt	matt	matt	matt	matt
♣C	♣C	♣C	♣C	♣C	♣C
μ ≥ 0,6	μ ≥ 0,6	μ ≥ 0,6	μ ≥ 0,6	μ ≥ 0,6	μ ≥ 0,6
XPD58023 ○ 1110 St	XPE58023 ○ 1110 St	XPC58023 ○ 1110 Set	XPP57023 ○ 280 St	XPP57013 ○ 530 St	
				XPP57005 ○ 530 St	XPC55005 ○ 610 St
16	16	1 Set	24	24	10
5	5	-	5	5	5
12,0	6,5	8,8	18,0	18,0	6,5







Produkt product	 Überflutungsrinne Wiesbaden overflow channel Wiesbaden	 Lochstein Wiesbaden overflow channel Wiesbaden - outlet	 Innenecke Wiesbaden (Set 2 St) inside corner Wiesbaden (set 2 pcs)	 Außenecke Wiesbaden (Set 4 St) outside corner Wiesbaden (set 4 pcs)
STO No. 030 - 059824				
	19,5×30	19,5×30	29,3×29,3	39,1×30
	195×300×200/140	195×300×200/140	(2×) 293×293×200/140	(2×) 391×300×200/140
Oberfläche surface	matt	matt	matt	matt
Farbe color				
WHITE weiß white	XPP51023 ○ 1580 St	XPD51023 ○ 1450 St	XPI51023 ○ 1610 Set	XPA51023 ○ 1620 Set
logistische Daten logistic information				
	1	1	1 Set	1 Set/3 box
	5	5	-	-
	9,2	6,5	12,8	23,8/3 box

 Überflutungsrinne Wiesbaden overflow channel Wiesbaden	 Lochstein Wiesbaden overflow channel Wiesbaden - outlet	 Innenecke Wiesbaden (Set 2 St) Inside corner Wiesbaden (set 2 pcs)	 Außenecke Wiesbaden (Set 4 St) outside corner Wiesbaden (set 4 pcs)
19,5×22,5	19,5×22,5	21,8×21,8	23,8×22,5
195×225×160/110	195×225×160/110	(2×) 218×218×160/110	(2×) 238×225×160/110
matt	matt	matt	matt
XPP52023 ○ 1110 St	XPD52023 ○ 1250 St	XPI52023 ○ 1450 Set	XPA52023 ○ 1450 Set
1	1	1 Set	1 Set
5	5	-	-
6,6	6,0	6,5	8,8

Produkt product	 Überlauf Rinne Wiesbaden overflow channel Wiesbaden	 Lochstein Wiesbaden overflow channel Wiesbaden - outlet	 Innenecke Wiesbaden (Set 2 St) inside corner Wiesbaden (set 2 pcs)	 Außenecke Wiesbaden (Set 2 St) outside corner Wiesbaden (set 2 pcs)
STO No. 030 - 059824				
	19,5×21,5	19,5×21,5	20,8×20,8	23,8×21,5
	195×215×140	195×215×140	(2×) 208×208×140	(2×) 238×215×140
Oberfläche surface	matt	matt	matt	matt
Farbe color				
WHITE weiß white	XPP53023 ○ 1110 St	XPD53023 ○ 1250 St	XPI53023 ○ 1450 Set	XPA53023 ○ 1450 Set
logistische Daten logistic information				
	1	1	1 Set	1 Set
	5	5	-	-
	6,5	6,8	8,0	8,0

 Stück-Anzahl pro laufenden Meter. | Number of pcs per linear metre.

 Überlauf Rinne Wiesbaden overflow channel Wiesbaden	 Lochstein Wiesbaden overflow channel Wiesbaden - outlet	 Innenecke Wiesbaden (Set 2 St) inside corner Wiesbaden (set 2 pcs)	 Außenecke Wiesbaden (Set 2 St) outside corner Wiesbaden (set 2 pcs)
19,5×15	19,5×15	14,3×14,3	23,8×15
195×150×100	195×150×100	(2×) 143×143×100	(2×) 238×150×100
matt	matt	matt	matt
XPP54023 ○ 1110 St	XPD54023 ○ 1200 St	XPI54023 ○ 1300 Set	XPA54023 ○ 1370 Set
1	1	1 Set	1 Set
5	5	-	-
3,5	3,3	2,5	6,0

Formteile | special pieces

Beckenrandstein | edging tile | **GTVDA...** | 198x115x10/21 mm

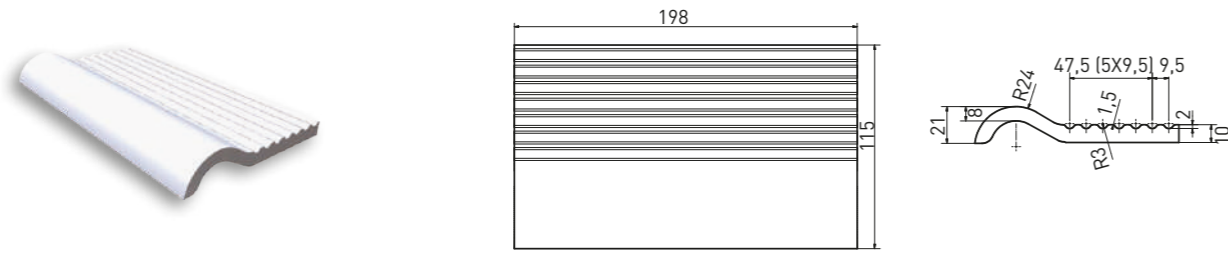

Innenecke Finnland (Set 2 St) | inside corner Finland (set 2 pcs) | **XPI56005** | (2x) 112x112x15/25 mm

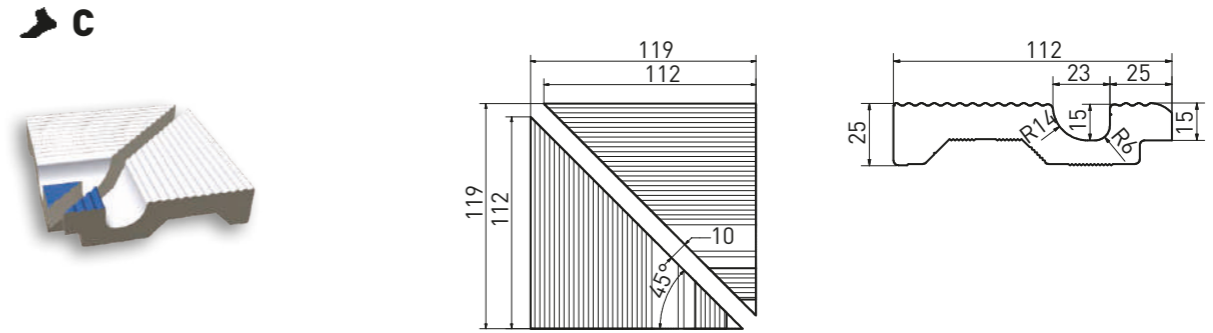

Beckenrandstein Zürich | edging tile Zürich | **XPP55005** | 197x115x15/45 mm

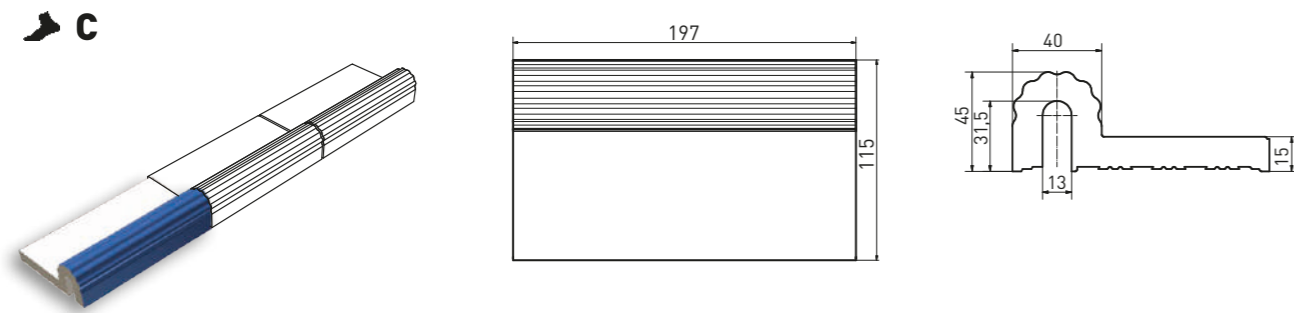

Außenecke Finnland (Set 2 St) | outside corner Finland (set 2 pcs) | **XPA56005** | (2x) 238x115x15/25 mm

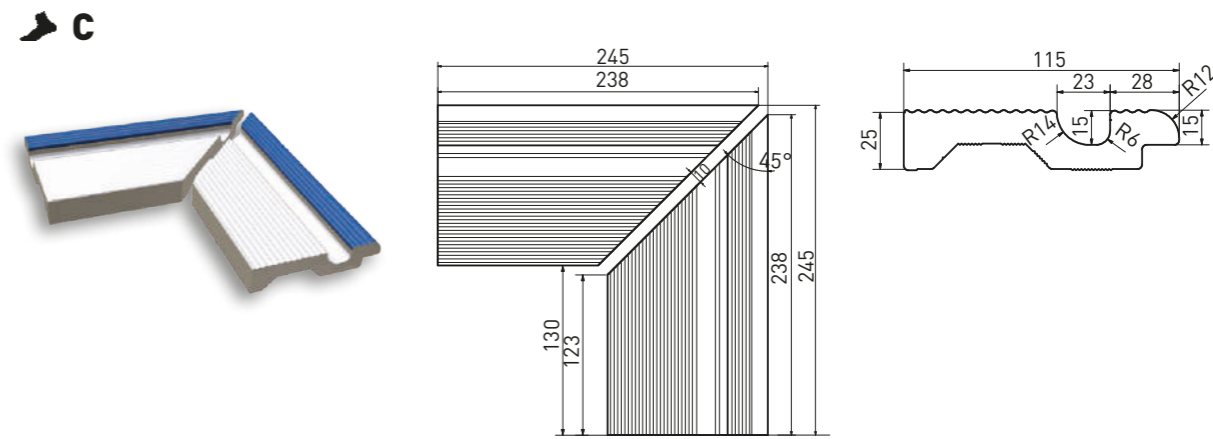

Handfaßstein Finnland | hand grip piece Finland | **XPP56005** | 197x115x15/25 mm

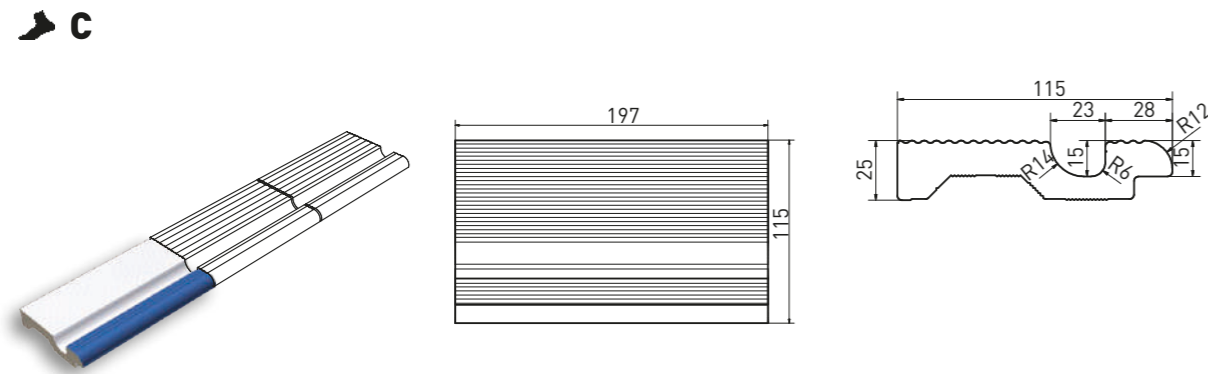

Muldenrinne | gutter tile | **XPP58023** | 197×150×35 mm

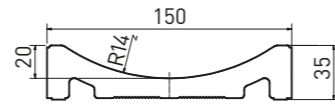
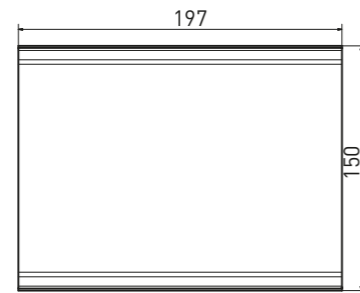
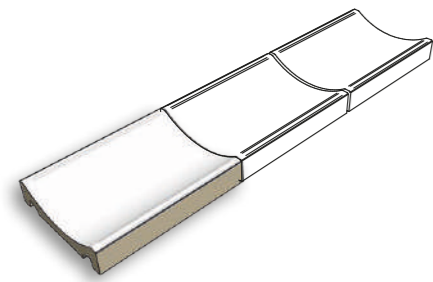

Muldenrinne Ablauf | gutter tile - outlet | **XPD58023** | 197×150×35 mm

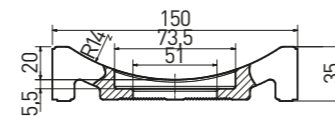
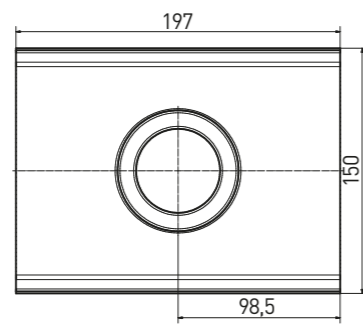
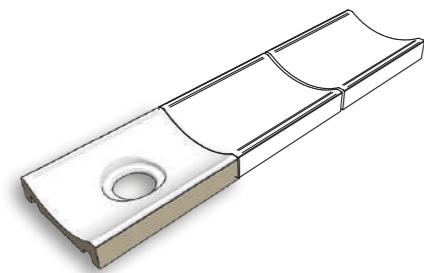

Muldenrinne Endstück | gutter tile - end | **XPE58023** | 197×150×35 mm

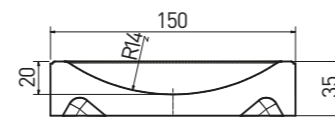
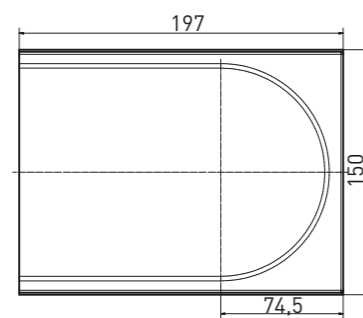
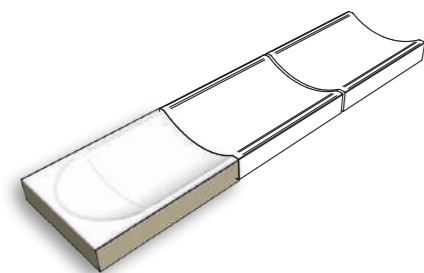

Muldenrinne Ecke [Set 2 St] | gutter tile - corner [set 2 pcs] | **XPC58023** | 197×150×35 mm

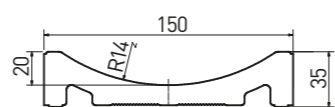
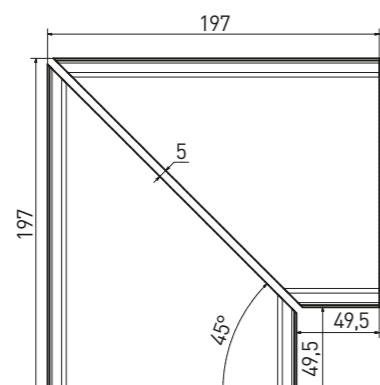
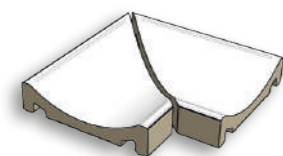

Rillenplatte | step tile flat | **XPP57023** | 197×150×10 mm

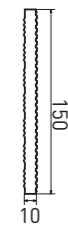
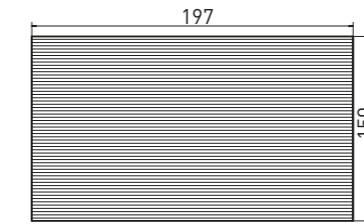
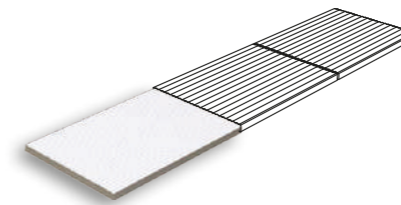

Rillenplatte - signal Längsrundung | step tile - signal radius | **XPP57005** - weiß | dunkelblau | white | dark blue | **XPP57013** - weiß | white | 197×150×10 mm

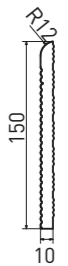
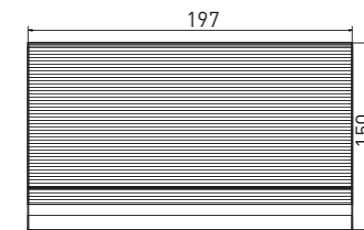
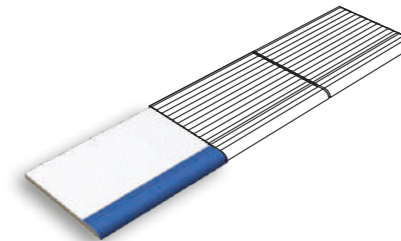

Treppenwinkel - signal Kante | step tile - signal edge | **XPC5005** | 197×115×10/52 mm

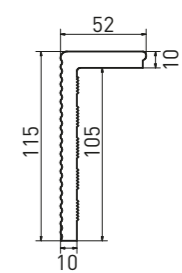
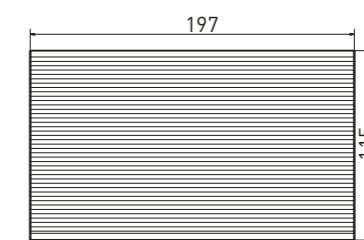
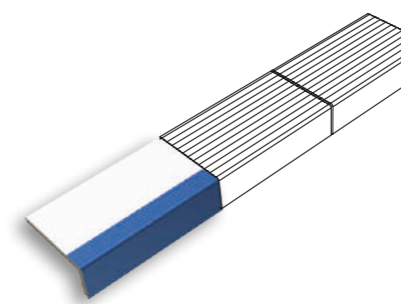

Überflutungsrinne Wiesbaden | overflow channel Wiesbaden | **XPP51023** | 195×300×200/140 mm

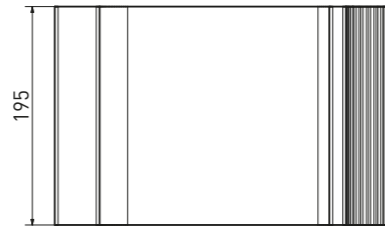
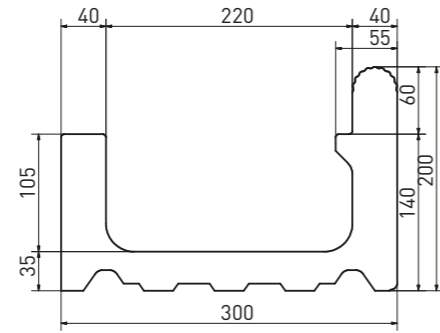
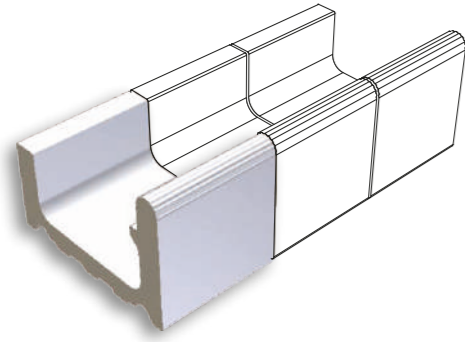

Lochstein Wiesbaden | overflow channel Wiesbaden - outlet | **XPD51023** | 195×300×200/140 mm

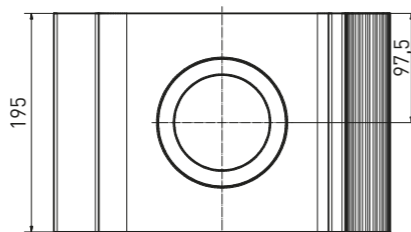
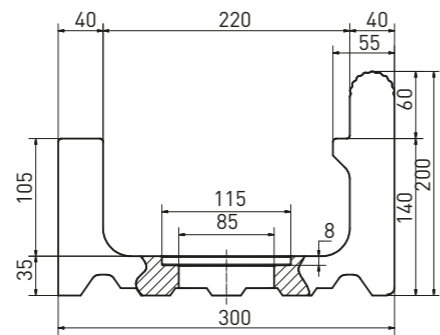
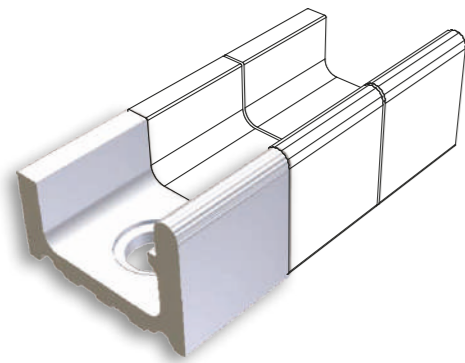

Innenecke Wiesbaden (Set 2 St) | inside corner Wiesbaden (set 2 pcs) | **XPI51023** | (2x) 293×293×200/140 mm

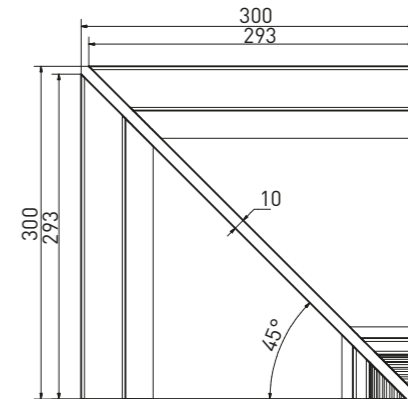
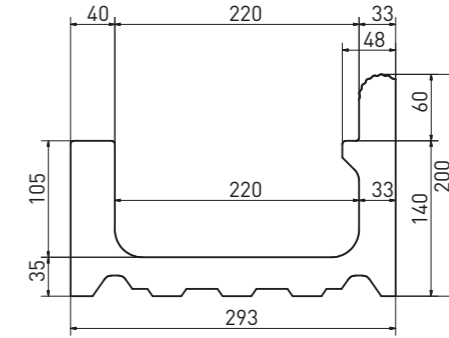
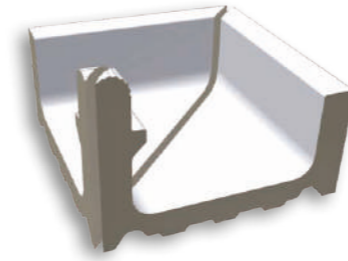

Außenecke Wiesbaden (Set 4 St) | outside corner Wiesbaden (set 4 pcs) | **XPA51023** | (2x) 391×300×200/140 mm

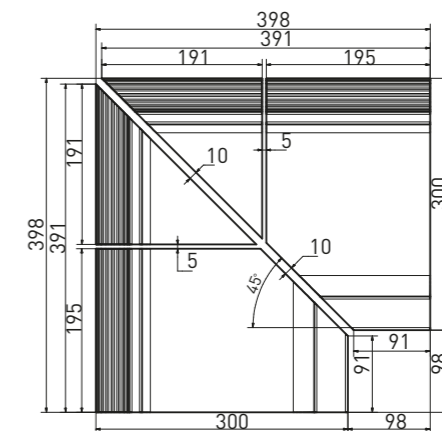
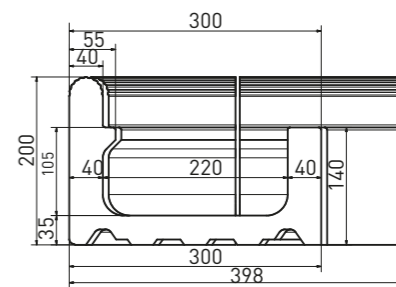
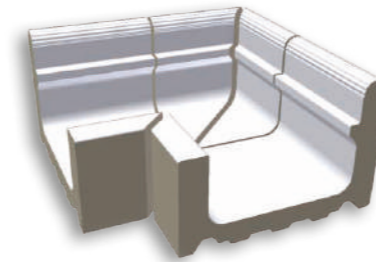

Formteile | special pieces

Überflutungsrinne Wiesbaden | overflow channel Wiesbaden | **XPP52023** | 195×225×160/110 mm

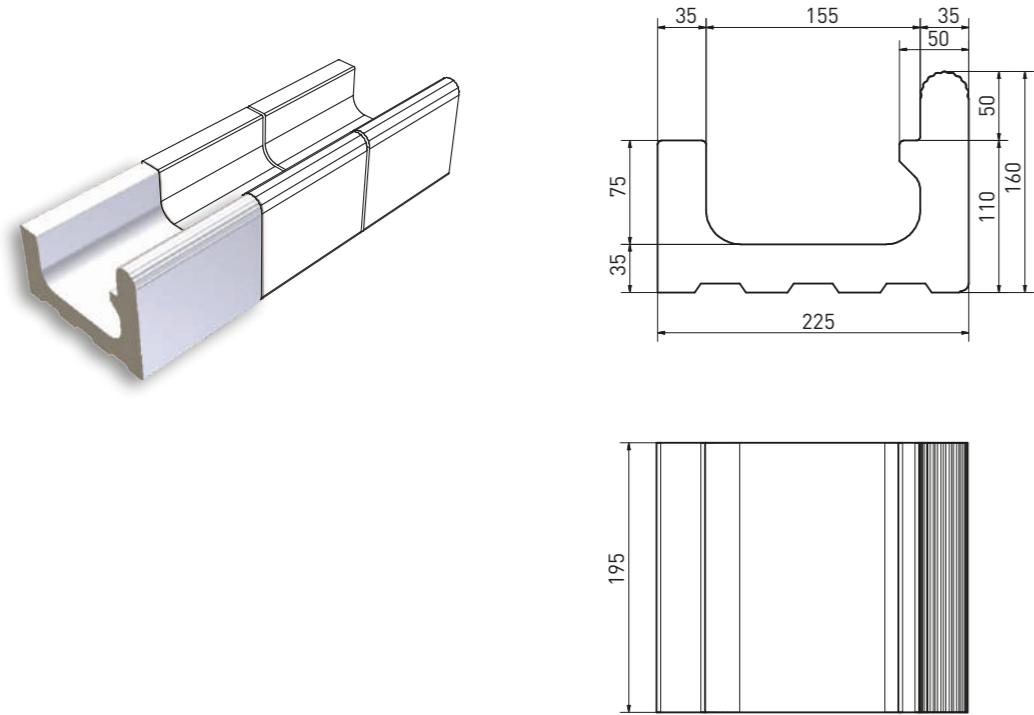

Innenecke Wiesbaden (Set 2 St) | inside corner Wiesbaden (set 2 pcs) | **XPI52023** | (2x) 218×218×160/110 mm

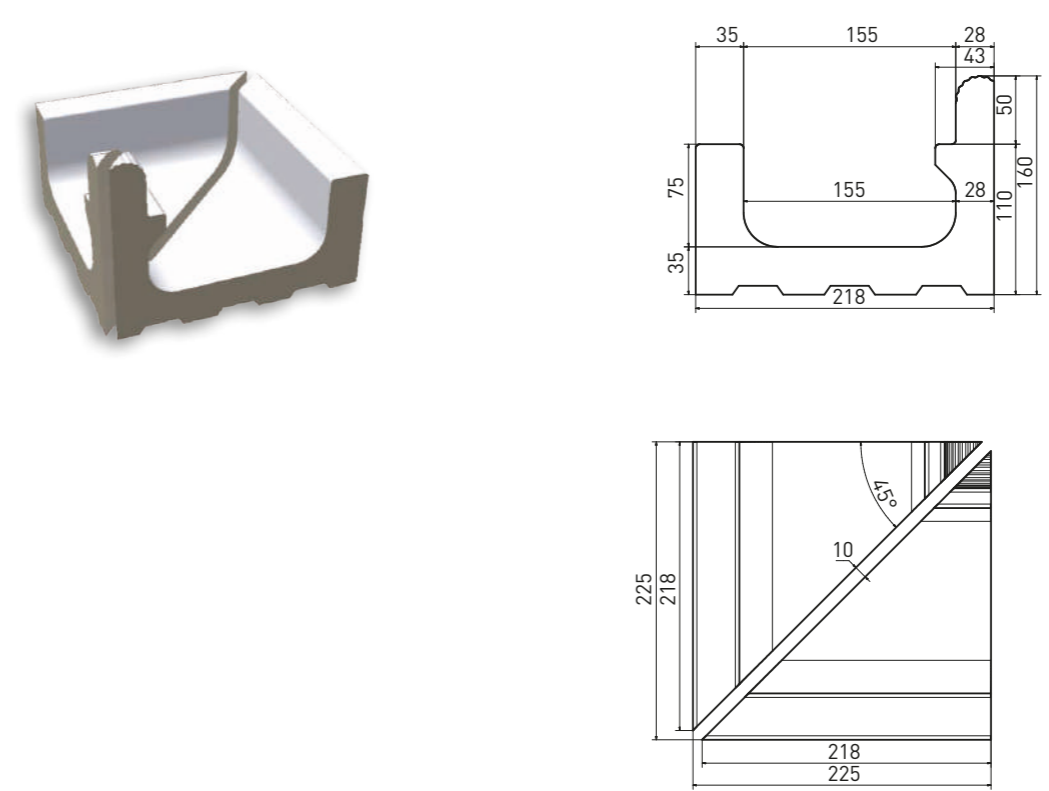

Lochstein Wiesbaden | overflow channel Wiesbaden - outlet | **XPD52023** | 195×225×160/110 mm

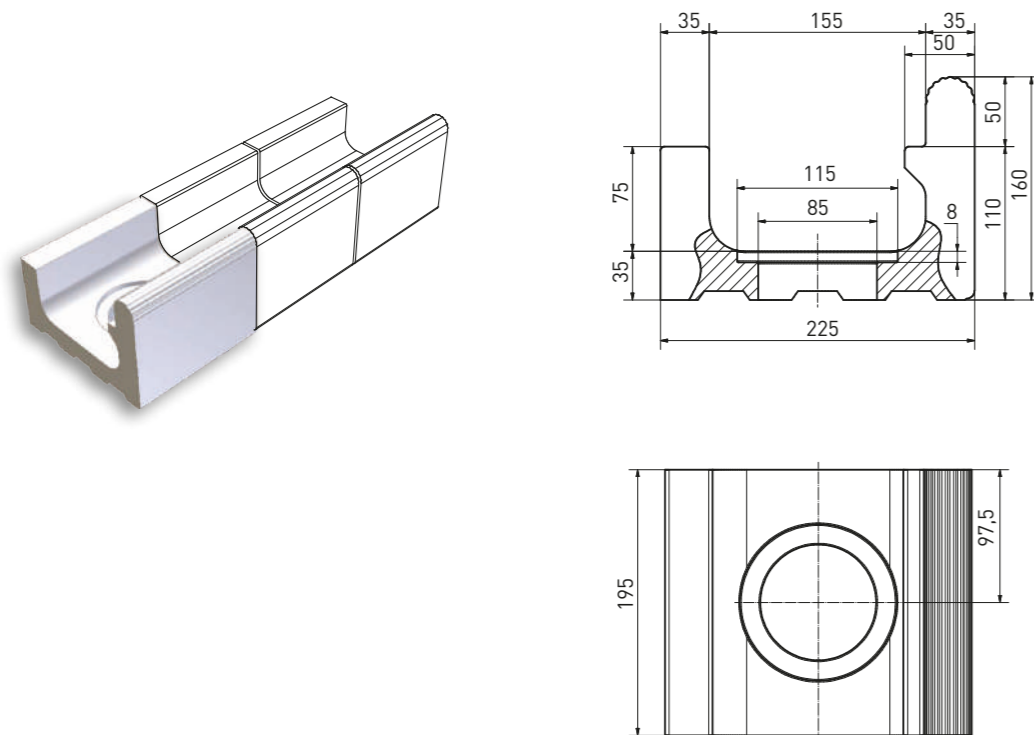

Außenecke Wiesbaden (Set 2 St) | outside corner Wiesbaden (set 2 pcs) | **XPA52023** | (2x) 238×225×160/110 mm

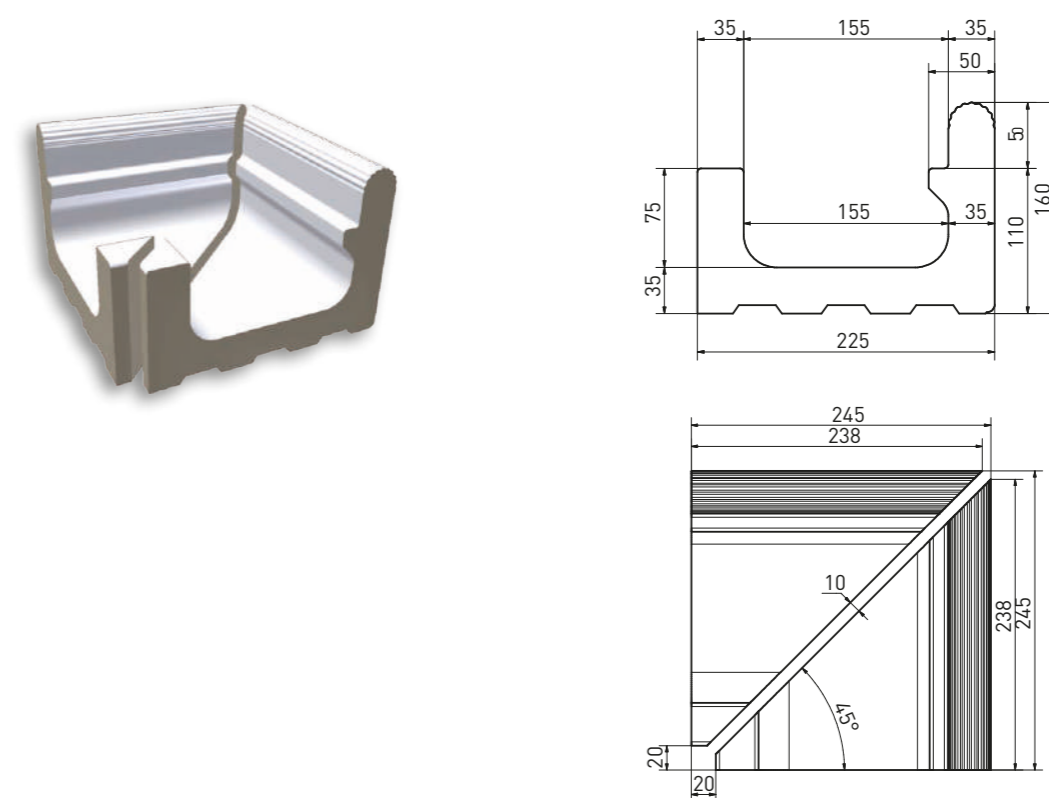

Überlaufrinne Wiesbaden | overflow channel Wiesbaden | **XPP53023** | 195×215×140 mm

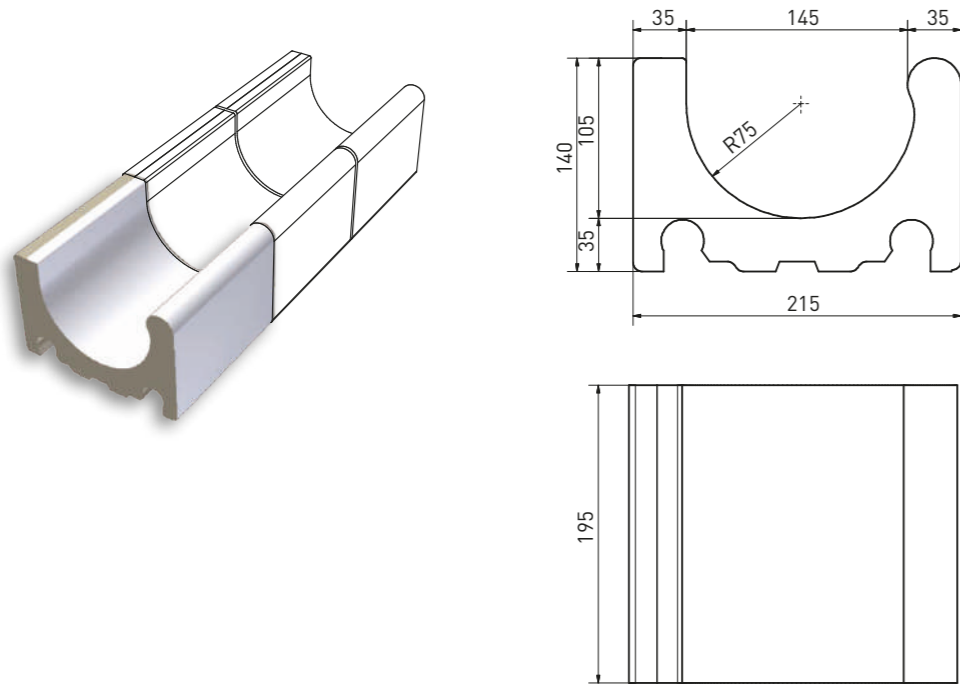

Innenecke Wiesbaden (Set 2 St) | inside corner Wiesbaden (set 2 pcs) | **XPI53023** | (2x) 208×208×140 mm

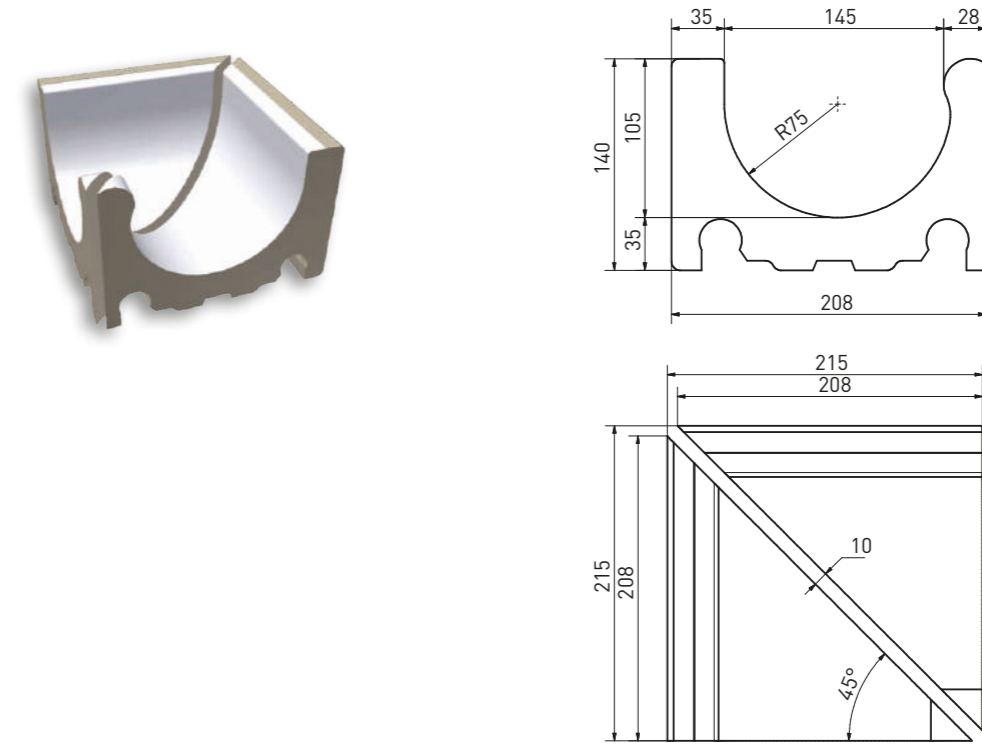

Lochstein Wiesbaden | overflow channel Wiesbaden - outlet | **XPD53023** | 195×215×140 mm

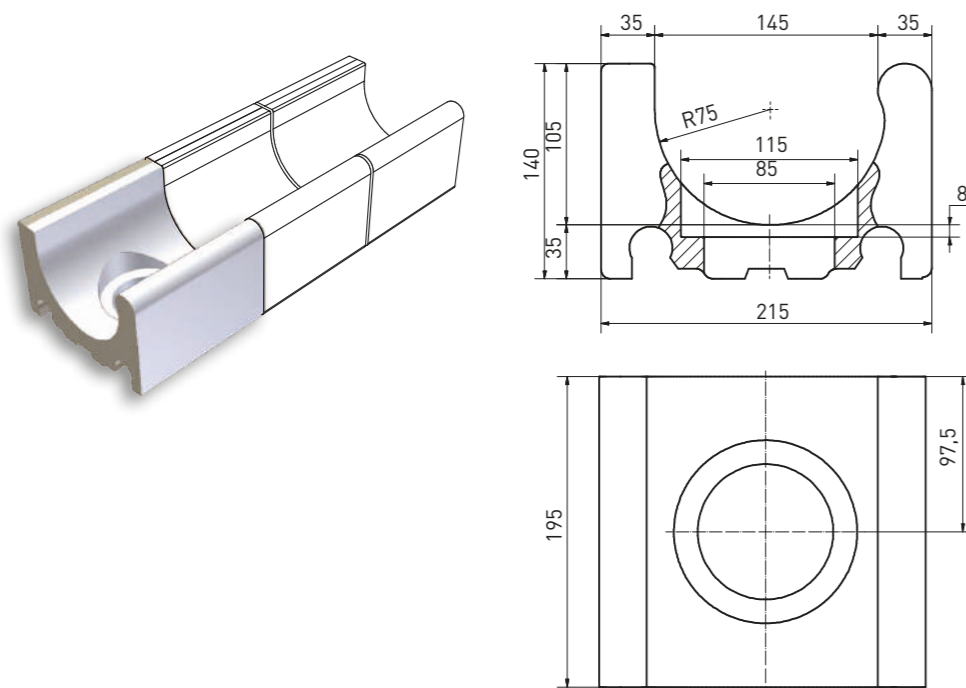

Außenecke Wiesbaden (Set 2 St) | outside corner Wiesbaden (set 2 pcs) | **XPA53023** | (2x) 238×215×140 mm

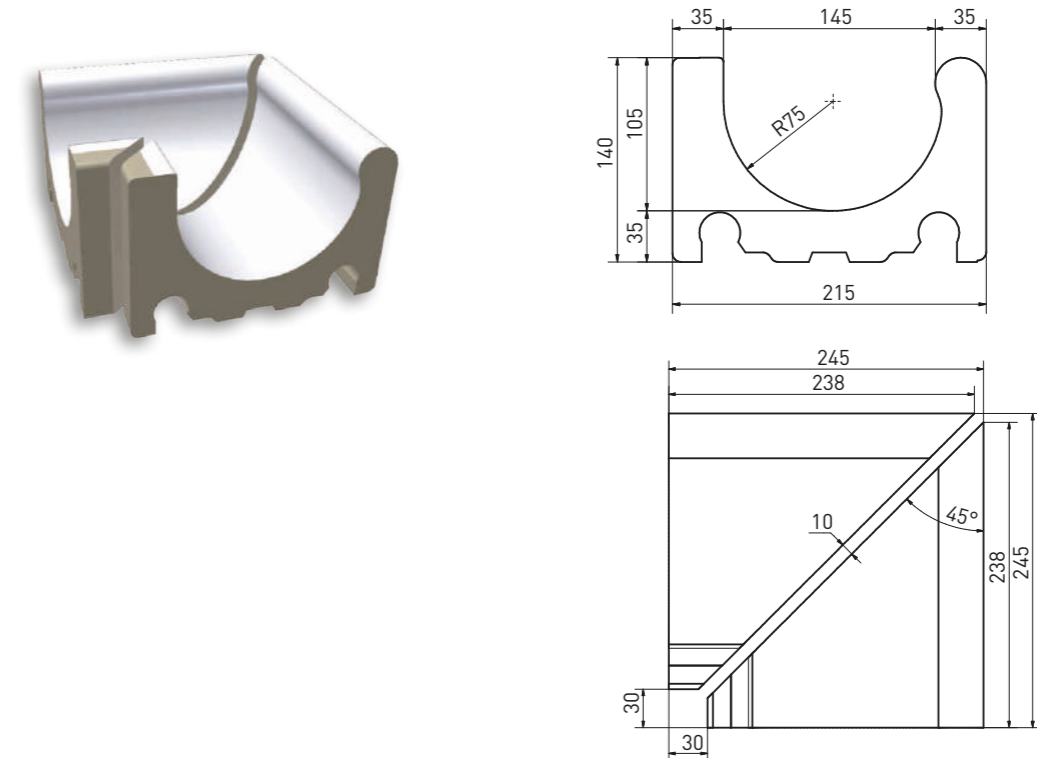

Überlaufrinne Wiesbaden | overflow channel Wiesbaden | **XPP54023** | 195×150×100 mm

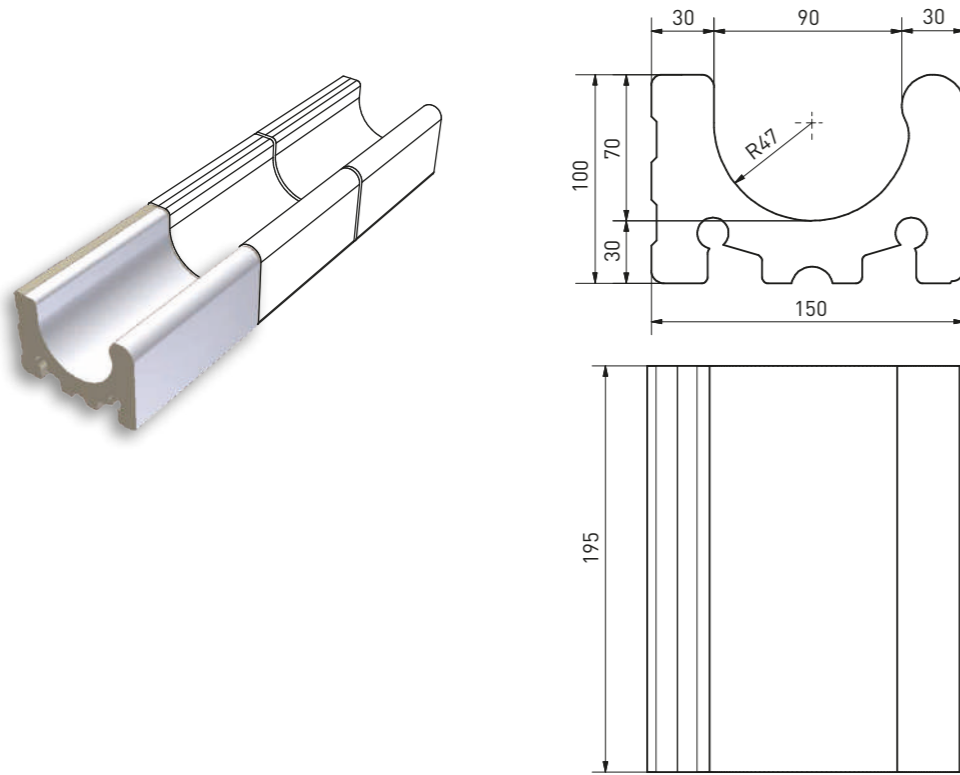

Innenecke Wiesbaden (Set 2 St) | inside corner Wiesbaden (set 2 pcs) | **XPI54023** | (2x) 143×143×100 mm

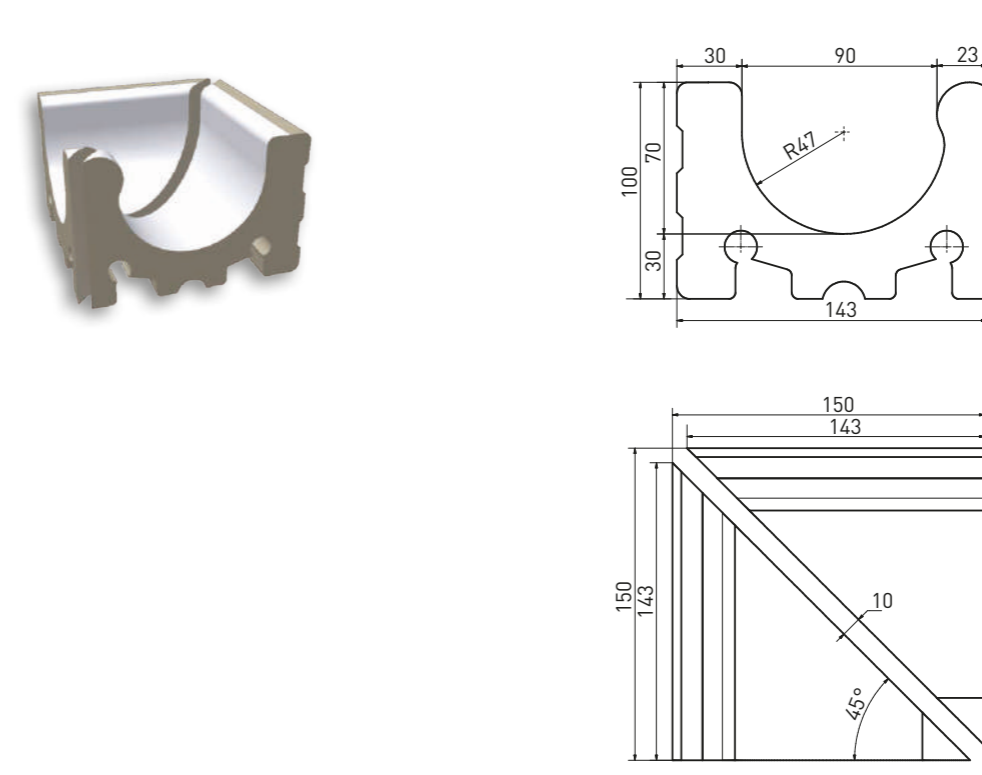

Lochstein Wiesbaden | overflow channel Wiesbaden - outlet | **XPD54023** | 195×150×100 mm

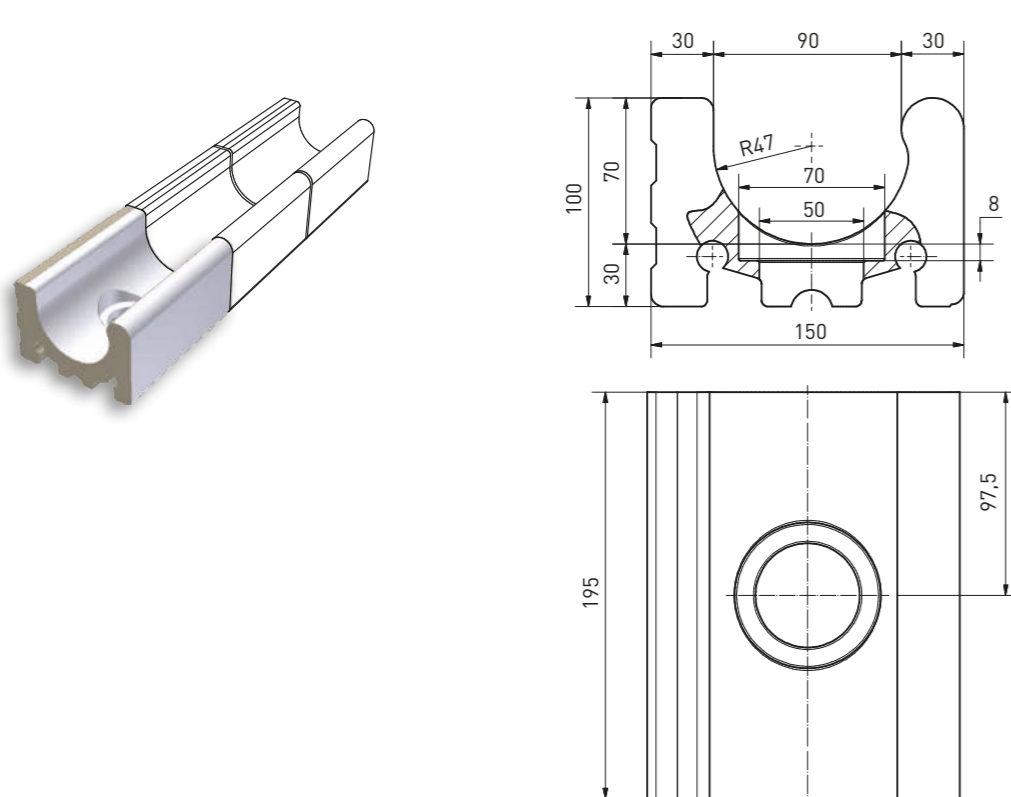

Außenecke Wiesbaden (Set 2 St) | outside corner Wiesbaden (set 2 pcs) | **XPA54023** | (2x) 238×150×100 mm

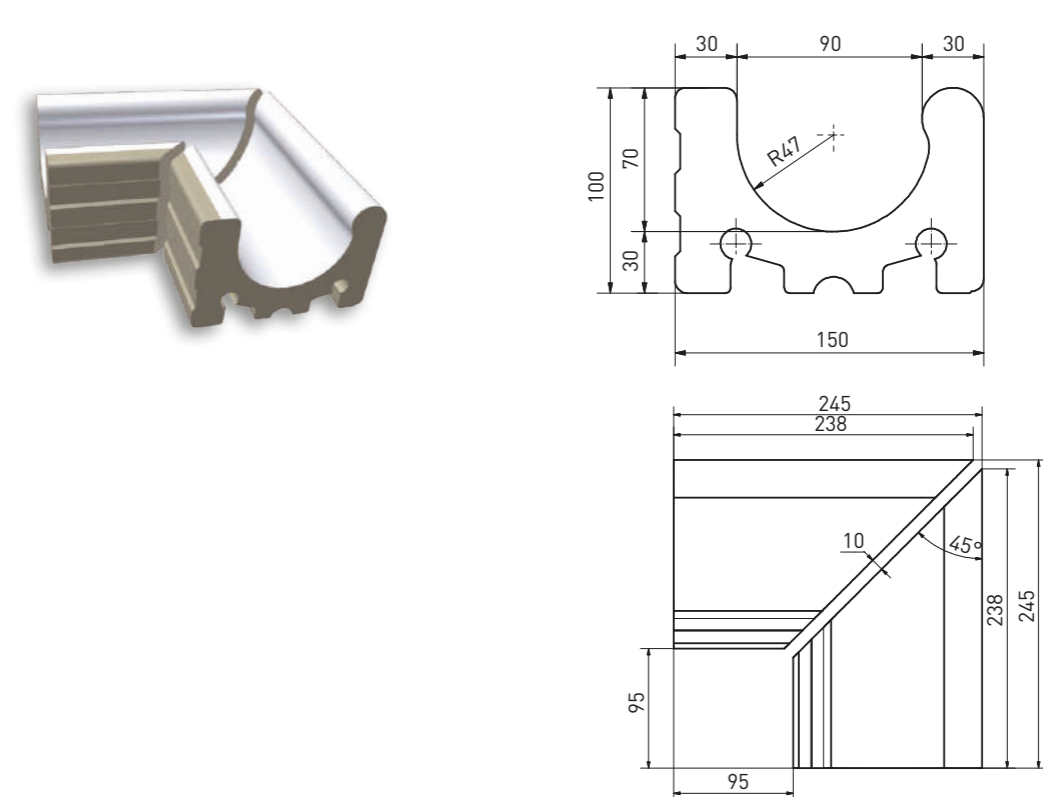



Since 1883

RAKO

Complete Ceramic Solution

2025





60x120

R10/B



DARV9876
 ○ 700 l m²
 relief matt | structure matt
 color **day**
 elfenbein | ivory



DARV9877
 ○ 700 l m²
 relief matt | structure matt
 color **sunrise**
 beige | beige



60x120

R10/B



DARV9874
 ○ 700 l m²
 relief matt | structure matt
 color **twilight**
 grau | grey

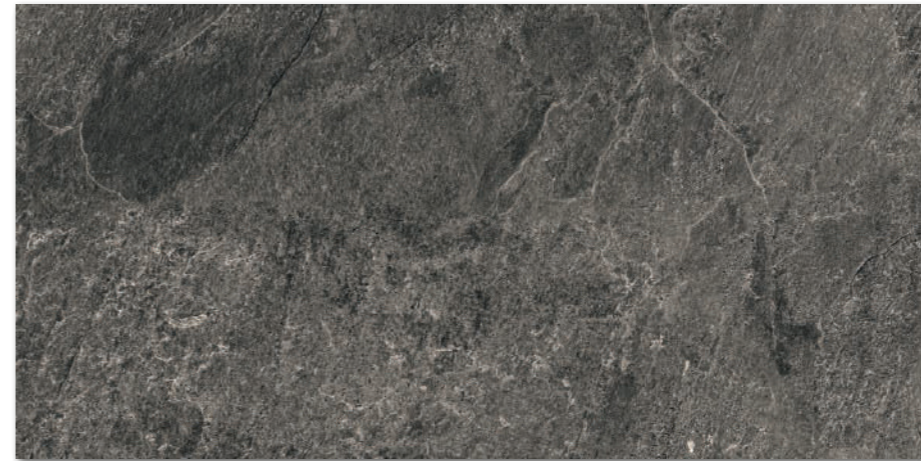

DARV9875
 ○ 700 l m²
 relief matt | structure matt
 color **night**
 schwarz | black





60x60
R10/B
v4
R

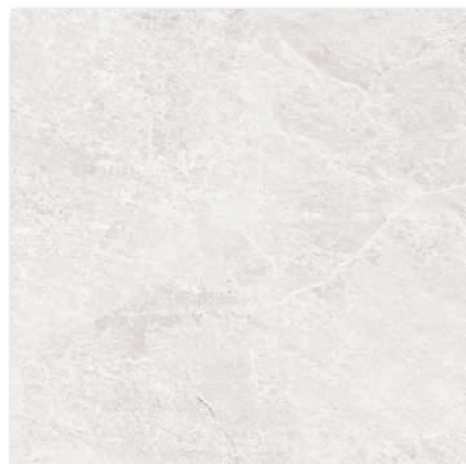

DAR62876
○ 560 l m²
relief matt | structure matt



DAR62877
○ 560 l m²
relief matt | structure matt



DAR62874
○ 560 l m²
relief matt | structure matt



DAR62875
○ 560 l m²
relief matt | structure matt

30x60
v4
R

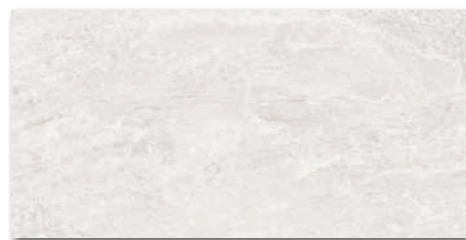

DARSR876
○ 540 l m²
relief matt | structure matt | R10/B

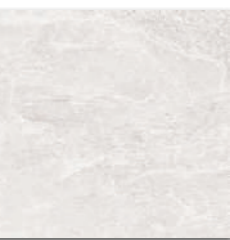

DAGSR876
○ 620 l m²
relief matt | structure matt | R11/C



DARSR877
○ 540 l m²
relief matt | structure matt | R10/B



DAGSR877
○ 620 l m²
relief matt | structure matt | R11/C

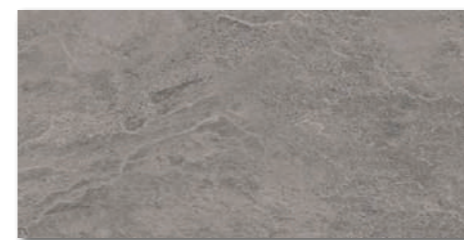

DARSR874
○ 540 l m²
relief matt | structure matt | R10/B



DAGSR874
○ 620 l m²
relief matt | structure matt | R11/C



DARSR875
○ 540 l m²
relief matt | structure matt | R10/B

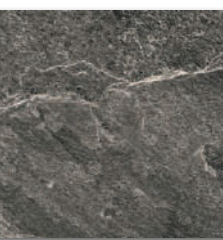

DAGSR875
○ 620 l m²
relief matt | structure matt | R11/C

10x10
v4
R10/B
v4
R



DAR11876 (SHEET)
○ 900 l m²
relief matt | structure matt



DAR11877 (SHEET)
○ 900 l m²
relief matt | structure matt

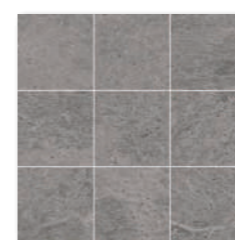

DAR11874 (SHEET)
○ 900 l m²
relief matt | structure matt

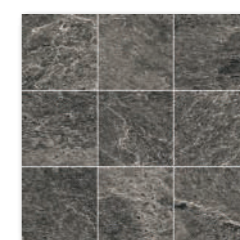

DAR11875 (SHEET)
○ 900 l m²
relief matt | structure matt

5x5 | 30x30
v4
R10/B
v4
R



DDM05876 (SHEET)
○ 300 l Netz
relief matt | structure matt
color **day**
elfenbein | ivory



DDM05877 (SHEET)
○ 300 l Netz
relief matt | structure matt
color **sunrise**
beige | beige

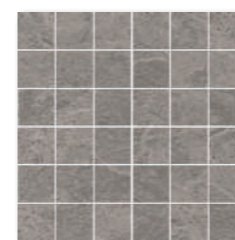

DDM05874 (SHEET)
○ 300 l Netz
relief matt | structure matt
color **twilight**
grau | grey

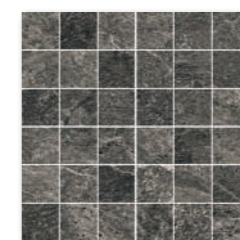

DDM05875 (SHEET)
○ 300 l Netz
relief matt | structure matt
color **night**
schwarz | black



60x60
R10/B
v4
R

News

30x60
v4
R

10x10
v4
R10/B
v4
R

RAKO Home

5x5 | 30x30
v4
R10/B
v4
R

Produkt product	cm	mm	EN	St/m ²	kg/m ²	kg	kg	kg	kg	kg	kg
Bodenfliese floor tile	60x60	598x598x9	EN 14411 - G Bla	4	2,8	1,44	32	46,08	29,1	20,2	955
Bodenfliese floor tile	30x60	298x598x9	EN 14411 - G Bla	7	5,6	1,26	40	50,40	24,2	19,2	993
Bodenfliese floor tile	10x10	98x98x9	EN 14411 - G Bla	11	11	1,00	56	56,00	19,2	19,2	1.125
Mosaik sheet 30x30 cm mosaic sheet 30x30 cm	5x5	48x48x9	EN 14411 - G Bla	3	11	0,27	-	-	5,2	-	-

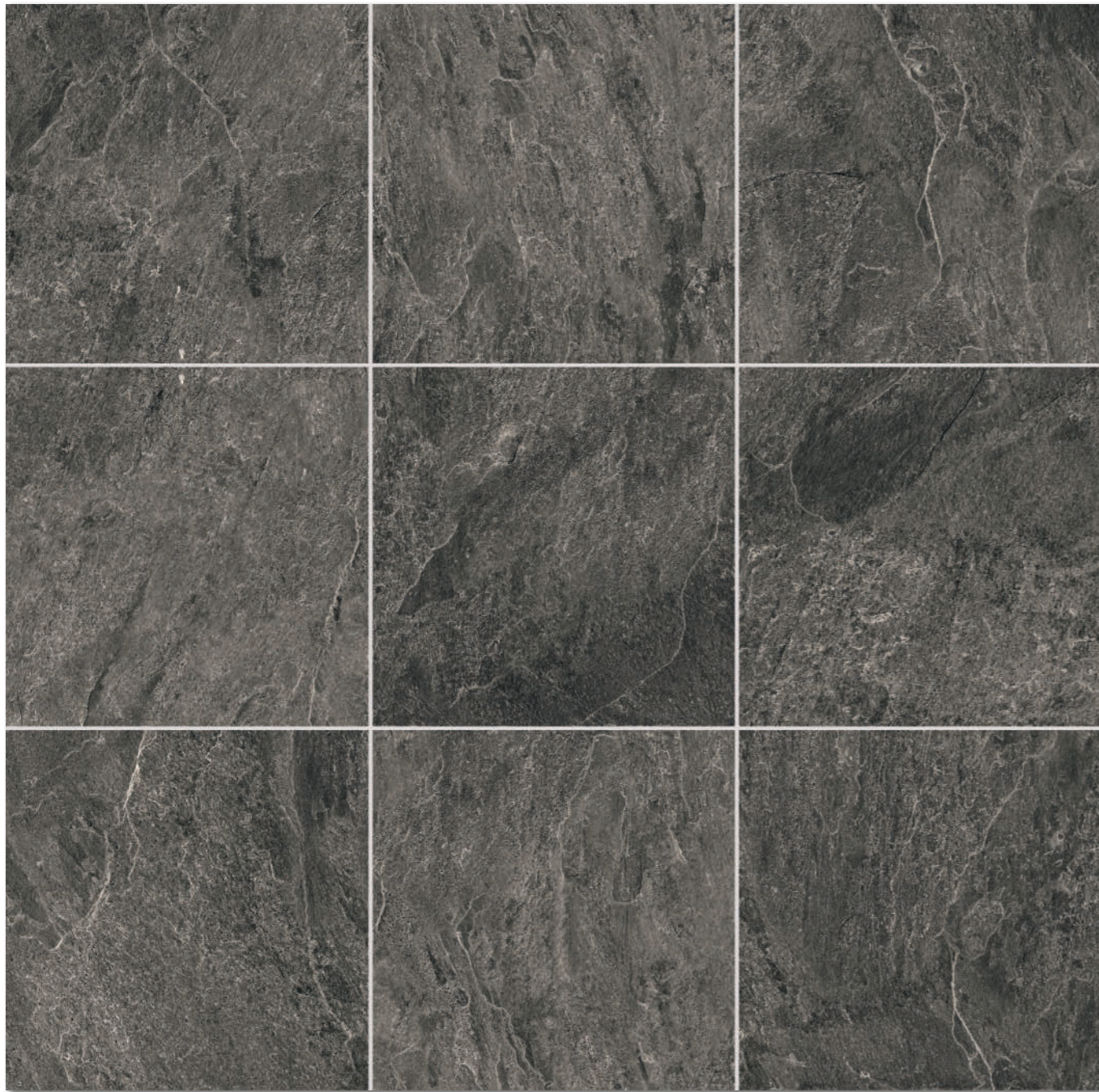

Die Fliesen der Serie zeichnen sich durch ein breites Farbspiel V4 aus. | All products of the entire batch show big deviations in shade difference V4.

Wir empfehlen, einzelne Fliesen aus mehreren Paketen herauszunehmen und den gesamten Bodenbelag nach der Inspirationsfotodokumentation in den Katalogen RAKO, eventuell den Webseiten www.rako.eu, zu komponieren. Wünschenswert ist die Kombination aller Fliesendesigns einschließlich ihrer Drehung um 90° oder 180°, sodass ausgewogene Optik der verlegten Fläche erzielt wird.

Before laying the tiles, we suggest you select from several cartons and arrange them as illustrated in the inspiration photo documentation in RAKO catalogues or website www.rako.eu, and mix the tiles to achieve the required result including turning them by 90° or 180°.

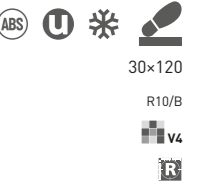

30x120

R10/B

V4

R

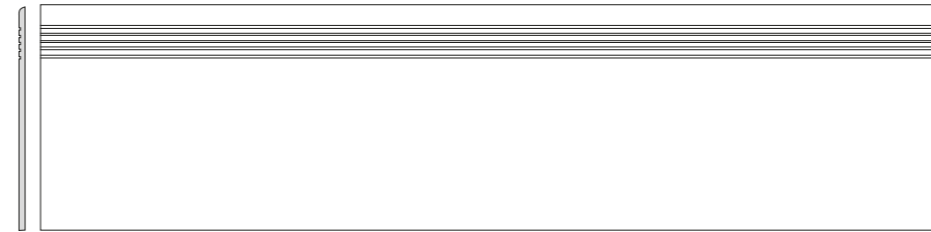

DCPVD874 color **twilight** | grau | grey
 DCPVD875 color **night** | schwarz | black
 DCPVD876 color **day** | elfenbein | ivory
 DCPVD877 color **sunrise** | beige | beige
 ○ 740 | St
 relief matt | structure matt

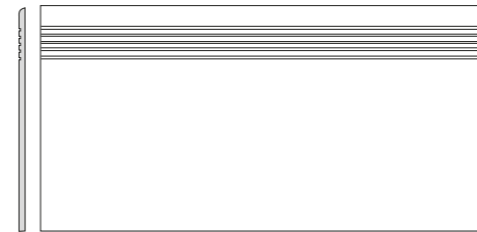

DCPSR874 color **twilight** | grau | grey
 DCPSR875 color **night** | schwarz | black
 DCPSR876 color **day** | elfenbein | ivory
 DCPSR877 color **sunrise** | beige | beige
 ○ 270 | St
 relief matt | structure matt



DSAS3874 color **twilight** | grau | grey
 DSAS3875 color **night** | schwarz | black
 DSAS3876 color **day** | elfenbein | ivory
 DSAS3877 color **sunrise** | beige | beige
 ○ 180 | St
 relief matt | structure matt

30x60

R10/B

V4

R

60x7,2

R

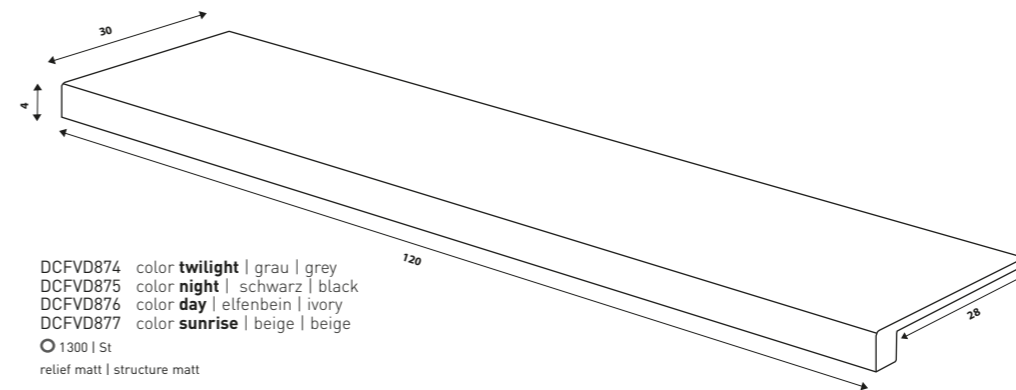

DCFVD874 color **twilight** | grau | grey
 DCFVD875 color **night** | schwarz | black
 DCFVD876 color **day** | elfenbein | ivory
 DCFVD877 color **sunrise** | beige | beige
 ○ 1300 | St
 relief matt | structure matt

30x120

R10/B

V4

R

Produkt product	cm	mm	EN	St/m ²	St/m ²	St/m ²	St/m ²	St/m ²	kg/m ²	brutto kg
Stufe step tile	30x120	298x1198x9	EN 14411 - G Bla	3	2,8	1,08	-	-	22,5	-
Stufe step tile	30x60	298x598x9	EN 14411 - G Bla	5	5,6	0,90	-	-	17,3	-
Sockel skirting plinth	60x7,2	598x72x9	EN 14411 - G Bla	14	23,1	0,60	-	-	11,5	-
Stufenformteil special step tile	30x120	298x1198x9	STD No. 030 - 059824	2	-	-	-	-	-	-

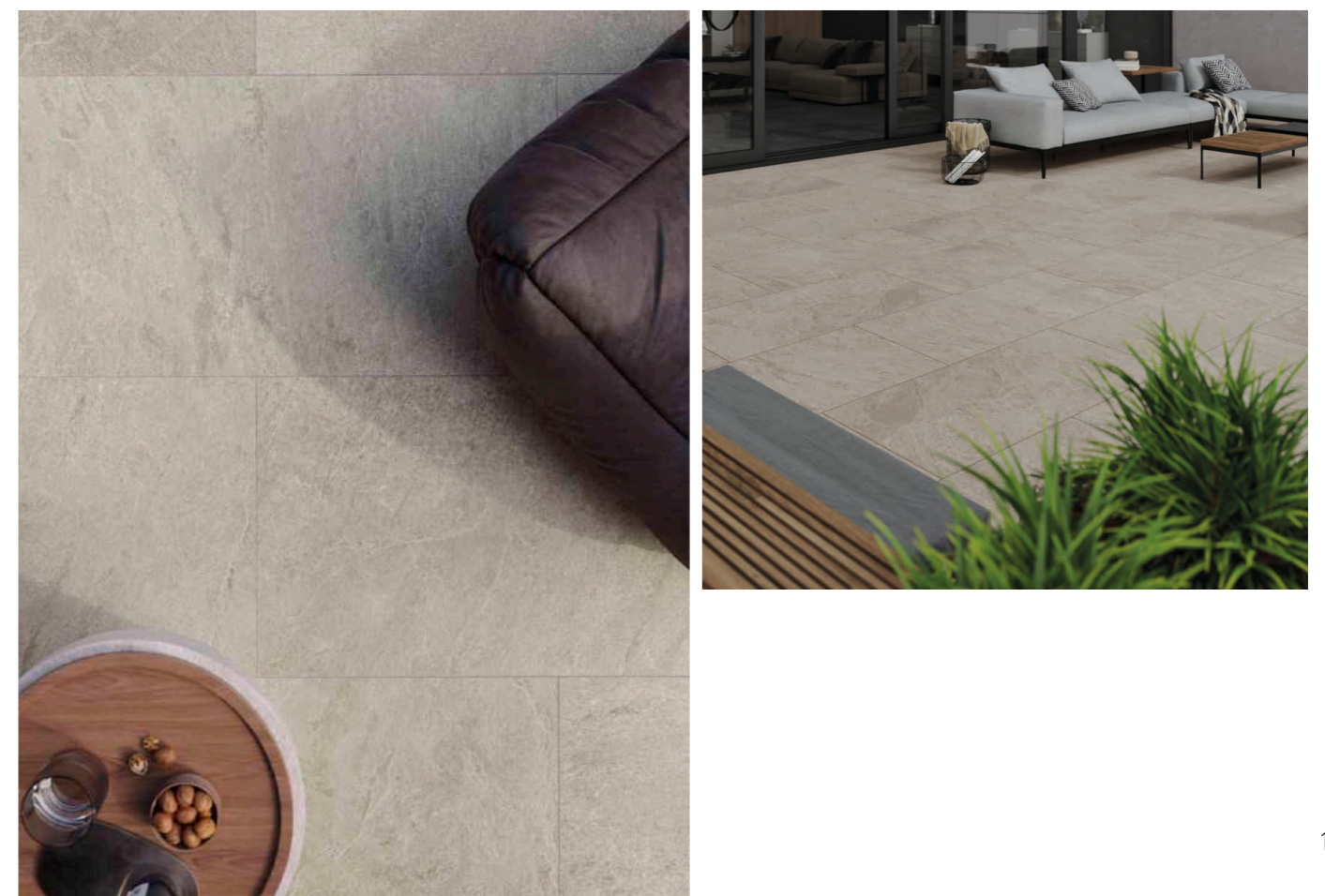
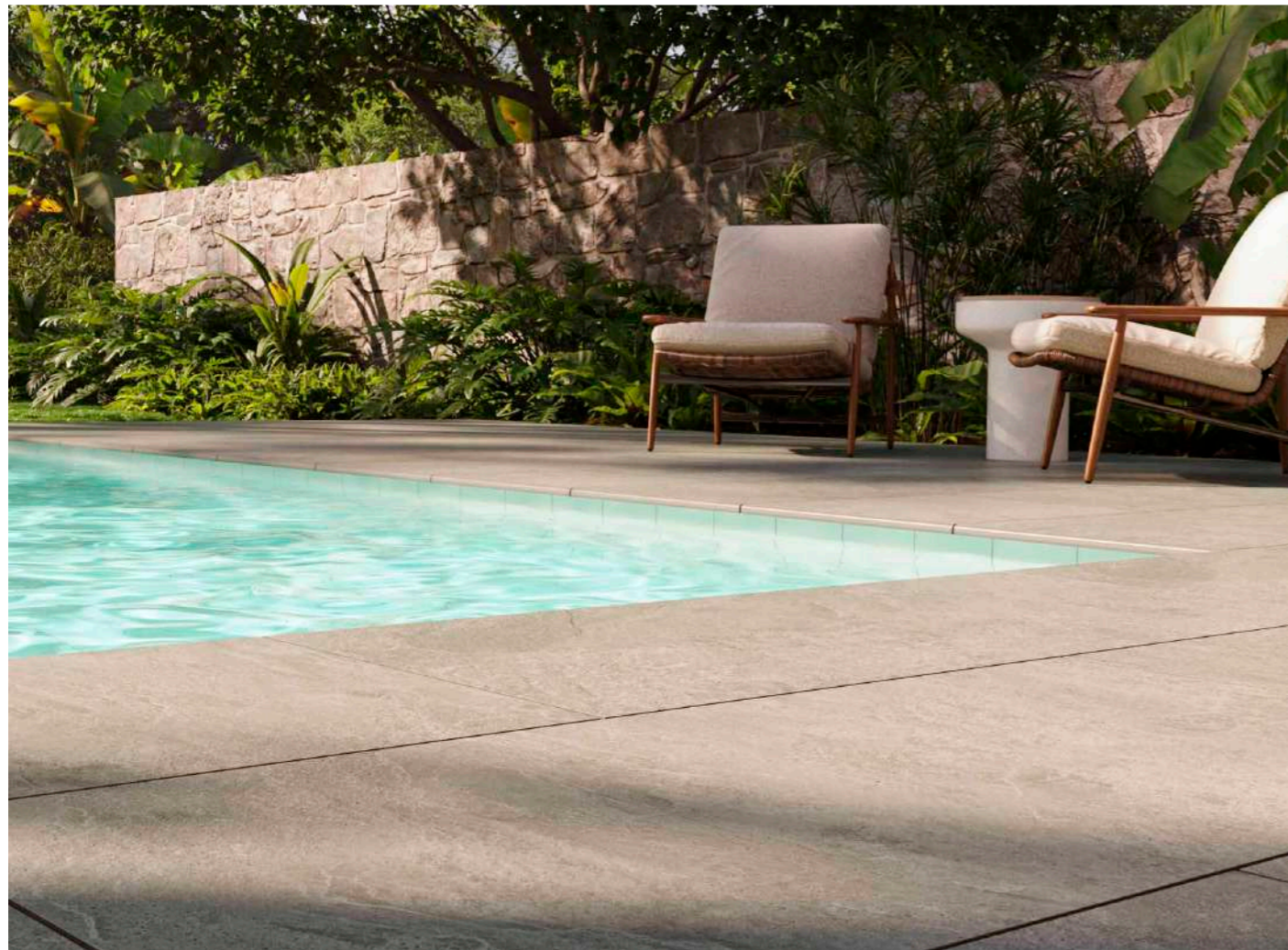



60x120

R11/B

v4

R

20mm



DARV6876
 ○ 850 l m²
 relief matt | structure matt
 color **day**
 elfenbein | ivory

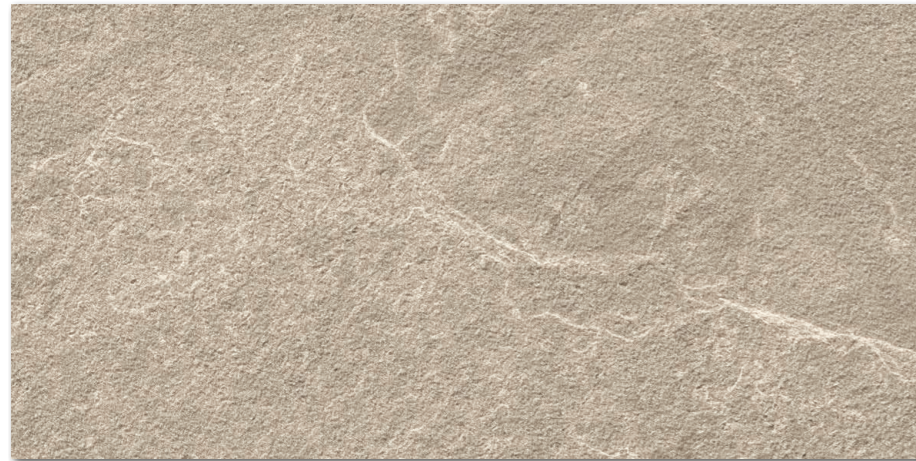

DARV6877
 ○ 850 l m²
 relief matt | structure matt
 color **sunrise**
 beige | beige



60x120

R11/B

v4

R

20mm



DARV6874
 ○ 850 l m²
 relief matt | structure matt
 color **twilight**
 grau | grey

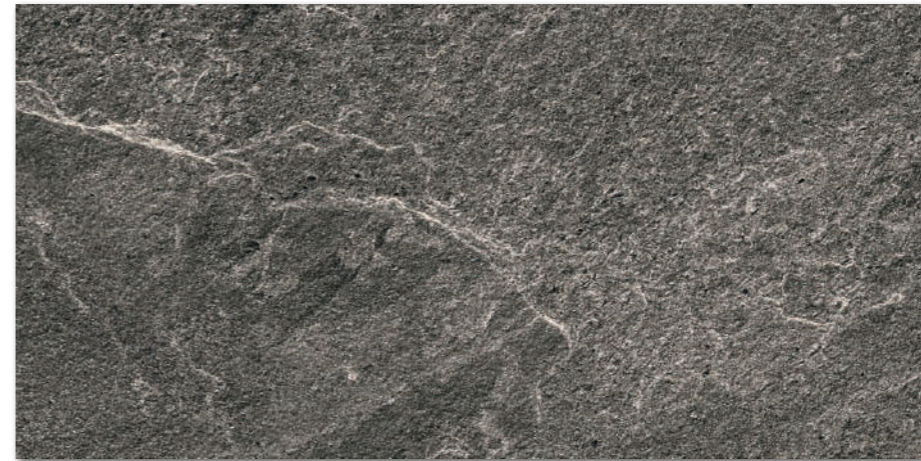

DARV6875
 ○ 850 l m²
 relief matt | structure matt
 color **night**
 schwarz | black

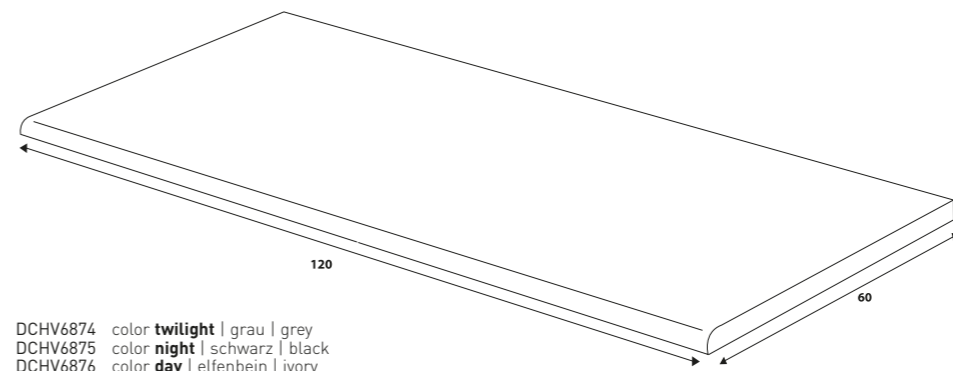

DCHV6874 color **twilight** | grau | grey
 DCHV6875 color **night** | schwarz | black
 DCHV6876 color **day** | elfenbein | ivory
 DCHV6877 color **sunrise** | beige | beige
 ○ 1150 l St
 relief matt | structure matt

Produkt | product



60x120



60-120



EN 14411 - G Bla



1



1,4



0,72



30



21,60



32,5



45,1



999

Bodenfliese | floor tile
 Stufe | step tile

60-120

598-1198-20

EN 14411 - G Bla

1

-

-

-

-

32,5

-

-

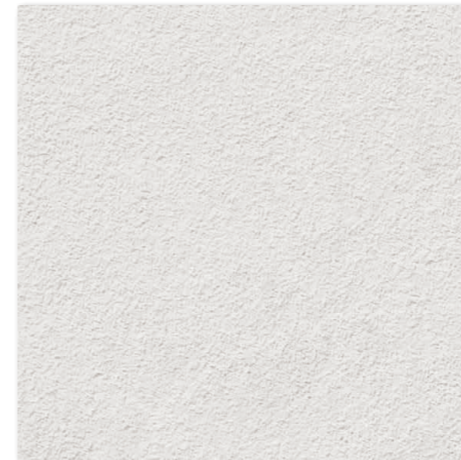

DAR66876
 ○ 760 l m²
 relief matt | structure matt
 color **day**
 elfenbein | ivory



DAR66874
 ○ 760 l m²
 relief matt | structure matt
 color **twilight**
 grau | grey



DAR66877
 ○ 760 l m²
 relief matt | structure matt
 color **sunrise**
 beige | beige

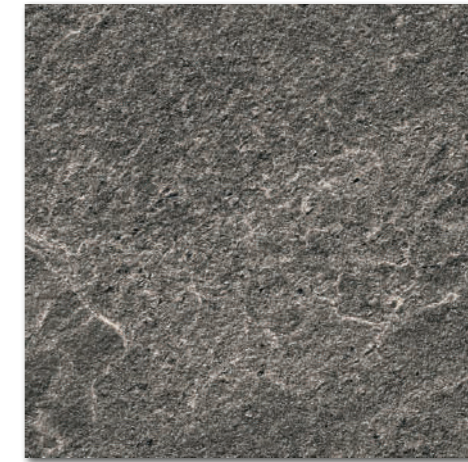

DAR66875
 ○ 760 l m²
 relief matt | structure matt
 color **night**
 schwarz | black

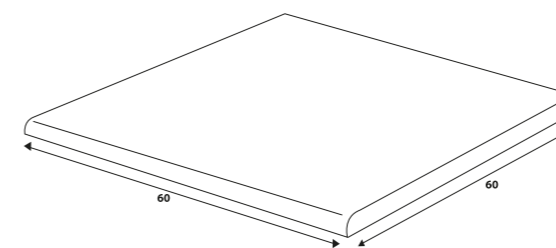

DCH66874 color **twilight** | grau | grey
 DCH66875 color **night** | schwarz | black
 DCH66876 color **day** | elfenbein | ivory
 DCH66877 color **sunrise** | beige | beige
 ○ 780 l St
 relief matt | structure matt

Produkt | product



Bodenfliese floor tile	60-60	598-598-20	EN 14411 - G Bla	2	2,8	0,72	30	21,60	32,5	45,1	999
Stufe step tile	60-60	598-598-20	EN 14411 - G Bla	2	-	-	-	-	32,5	-	-

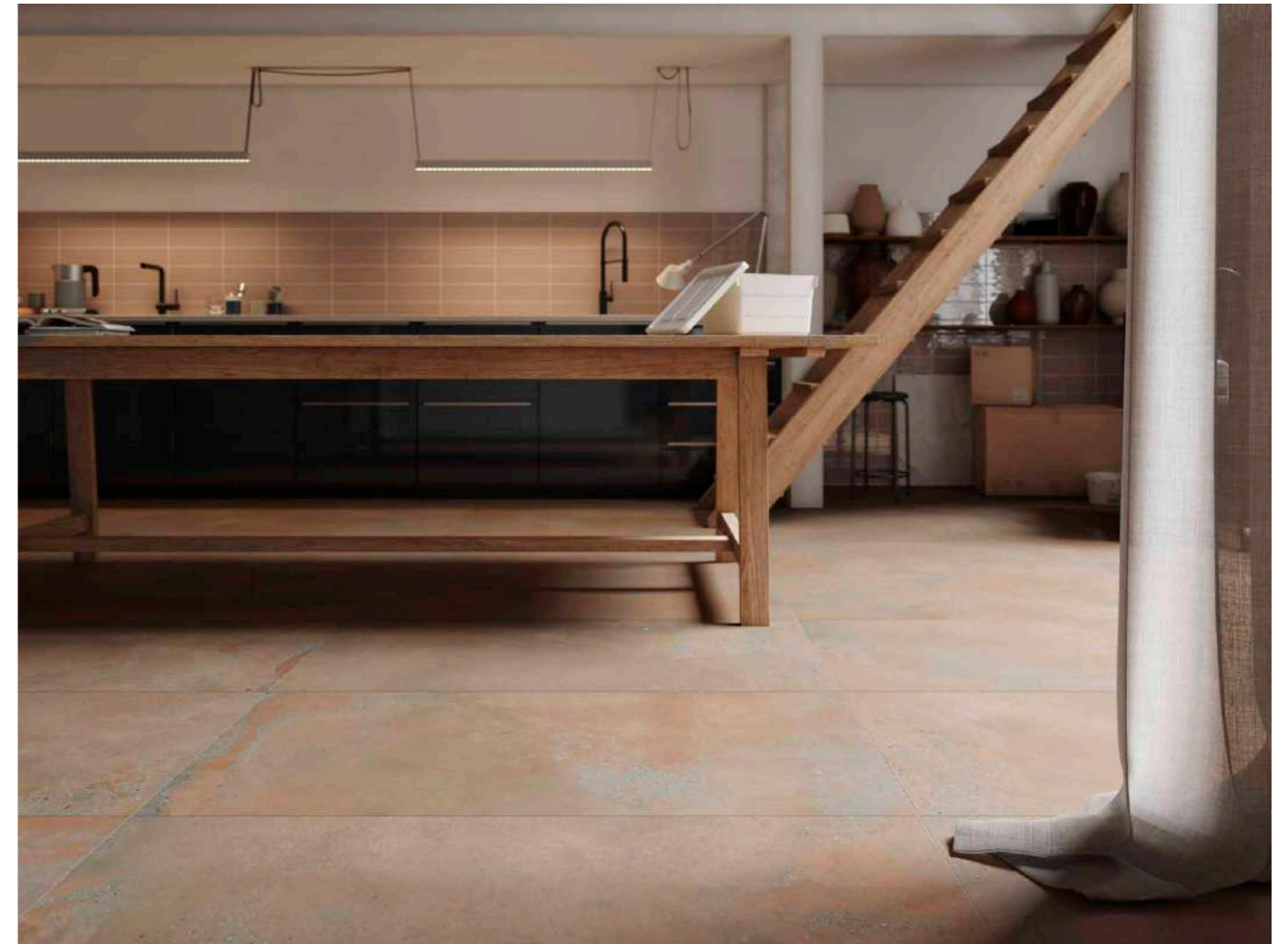
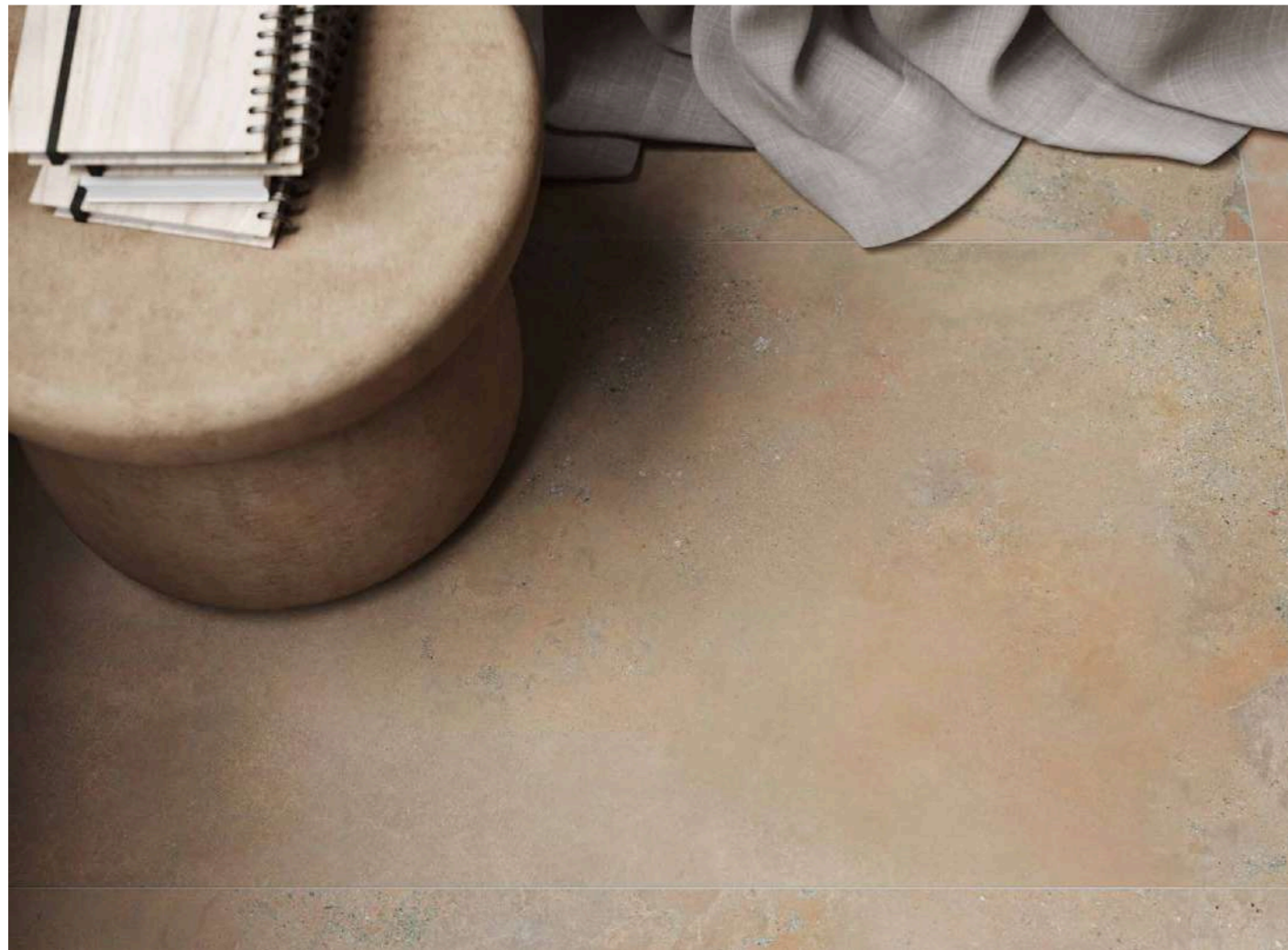



60x120

R10/B



DASV9891
PEI 5 ○ 700 l m²
matt

60x60

R10/B



DAS62891
PEI 5 ○ 560 l m²
matt

20x20

R10/B



DAK25891
PEI 5 ○ 780 l m²
matt
color **chamotte**
hellbeige | light beige



60x120

R10/B



DASV9892
PEI 4 ○ 700 l m²
matt

60x60

R10/B



DAS62892
PEI 4 ○ 560 l m²
matt

20x20

R10/B

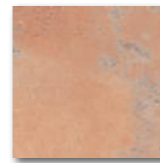

DAK25892
PEI 4 ○ 780 l m²
matt
color **pottery**
braun-rot | brown-red

Produkt product	cm	mm	EN	St/m ²	kg/m ²	kg/m ³	kg/m ²	kg/m ²	kg/m ²	kg/m ²	kg/m ²
Bodenfliese floor tile	60x120	598x1198x9	EN 14411 - G Bla	2	1,4	1,44	30	43,20	29,3	20,4	905
Bodenfliese floor tile	60x60	598x598x9	EN 14411 - G Bla	4	2,8	1,44	32	46,08	29,1	20,2	955
Bodenfliese floor tile	20x20	197x197x9	EN 14411 - G Bla	25	25	1,00	57	57,00	19,2	19,2	1 119

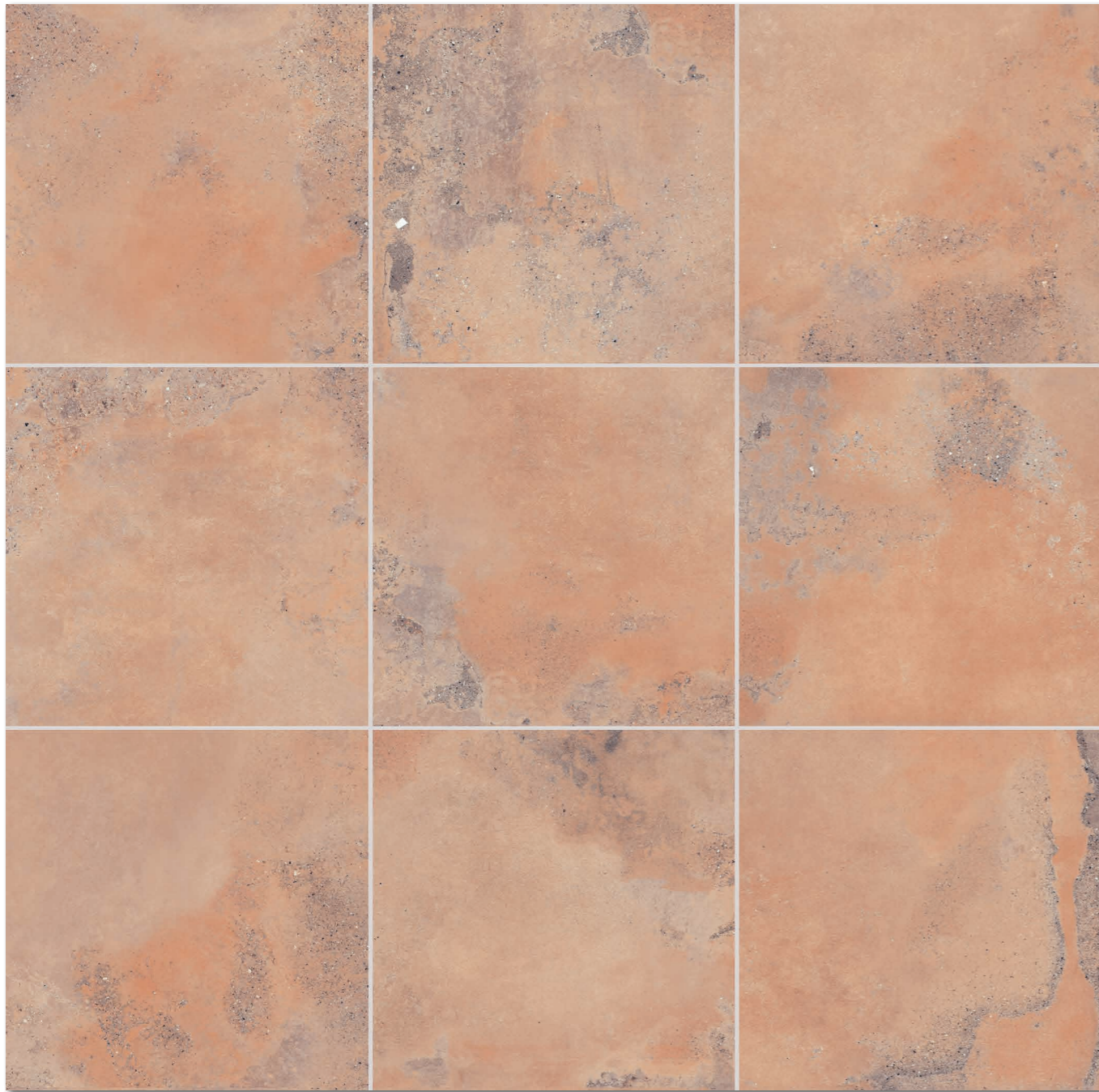

Die Fliesen der Serie zeichnen sich durch ein breites Farbspiel V4 aus. | All products of the entire batch show big deviations in shade difference V4.

Wir empfehlen, einzelne Fliesen aus mehreren Paketen herauszunehmen und den gesamten Bodenbelag nach der Inspirationsfotodokumentation in den Katalogen RAKO, eventuell den Webseiten www.rako.eu, zu komponieren. Wünschenswert ist die Kombination aller Fliesendesigns einschließlich ihrer Drehung um 90° oder 180°, sodass ausgewogene Optik der verlegten Fläche erzielt wird.

Before laying the tiles, we suggest you select from several cartons and arrange them as illustrated in the inspiration photo documentation in RAKO catalogues or website www.rako.eu, and mix the tiles to achieve the required result including turning them by 90° or 180°.

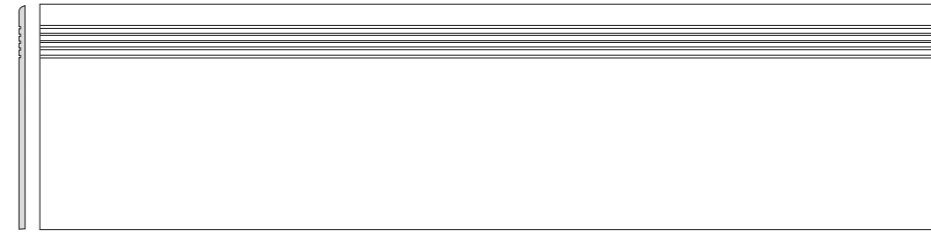

DCPVD891 color **chamotte** | hellbeige | light beige
 DCPVD892 color **pottery** | braun-rot | brown-red
 PEI 4-5 ○ 740 | St
 matt

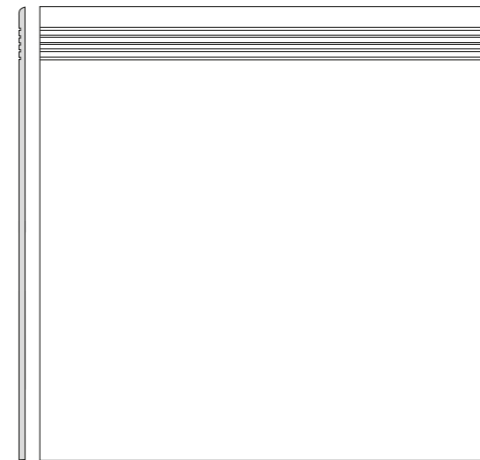

DCP62891 color **chamotte** | hellbeige | light beige
 DCP62892 color **pottery** | braun-rot | brown-red
 PEI 4-5 ○ 370 | St
 matt



DSAS3891 color **chamotte** | hellbeige | light beige
 DSAS3892 color **pottery** | braun-rot | brown-red
 ○ 180 | St
 matt

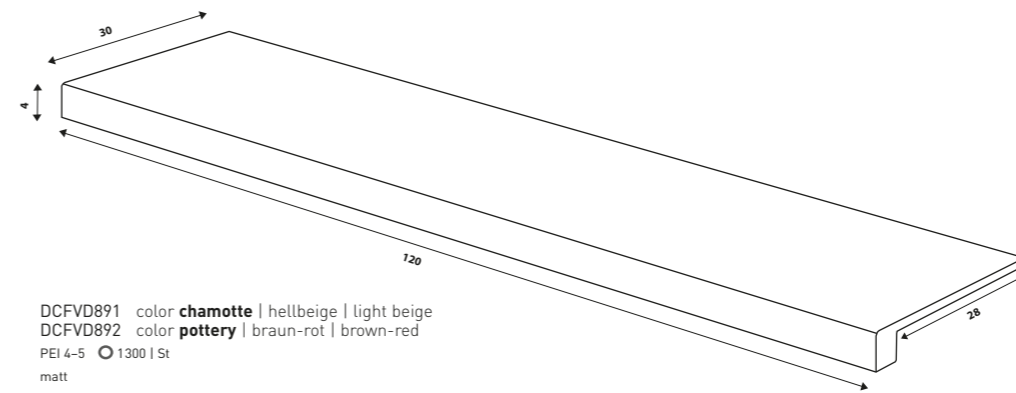

DCFVD891 color **chamotte** | hellbeige | light beige
 DCFVD892 color **pottery** | braun-rot | brown-red
 PEI 4-5 ○ 1300 | St
 matt



30x120

R10/B



60x60

R10/B



60x7,2



30x120

R10/B



Produkt | product



Produkt product	cm	mm	EN	kg	m²	m³	kg	kg	kg	kg
Stufe step tile	30x120	298x1198+9	EN 14411 - G Bla	3	2,8	1,08	-	-	22,5	-
Stufe step tile	60x60	598x597+9	EN 14411 - G Bla	3	2,8	1,08	-	-	21,9	-
Sockel skirting plinth	60x7,2	598x72+9	EN 14411 - G Bla	14	23,1	0,60	-	-	11,5	-
Stufenformteil special step tile	30x120	298x1198+9	STD No. 030 - 059824	2	-	-	-	-	-	-

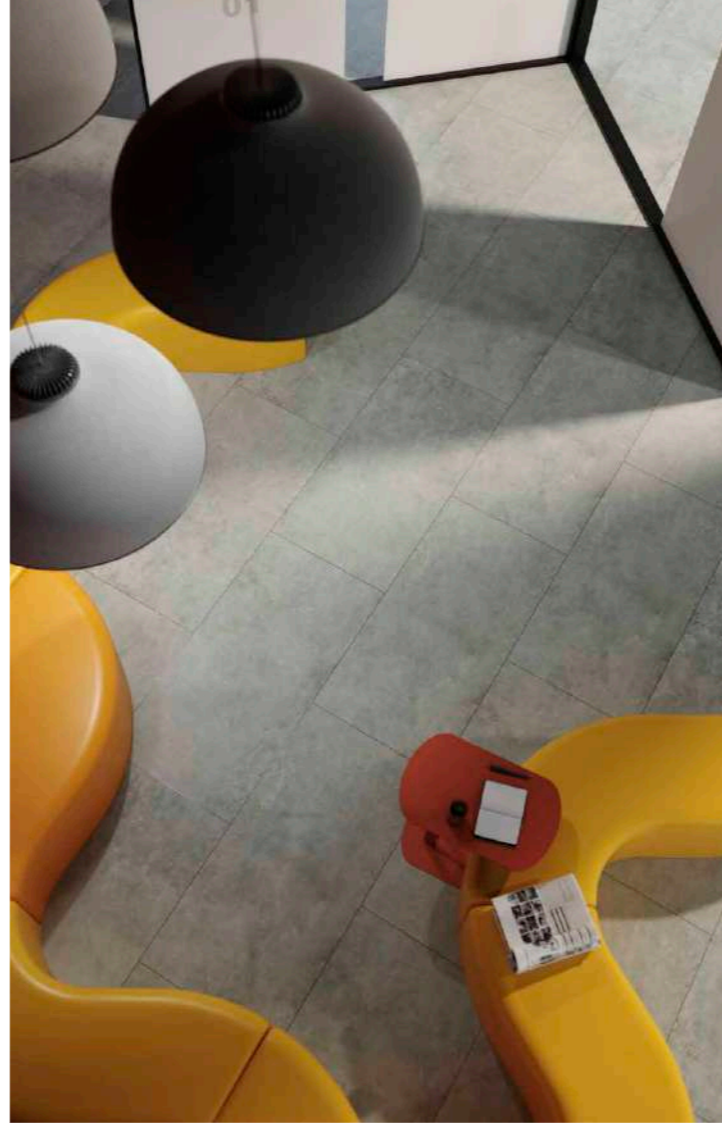
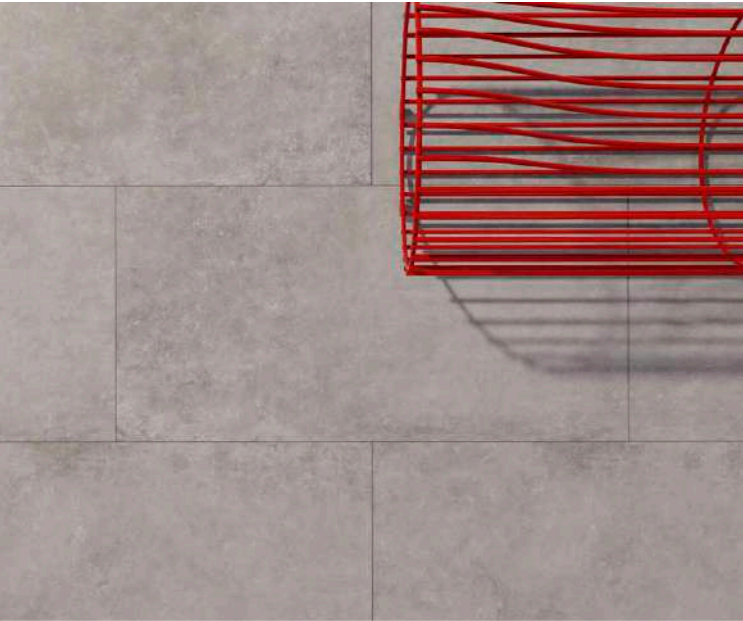

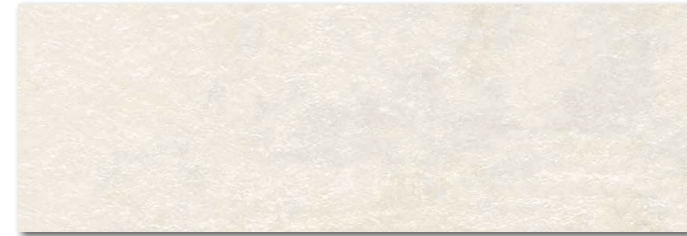

WARVN878
 ○ 750 l m²
 relief matt | structure matt
 color **swan**
 weiß-grau | white-grey

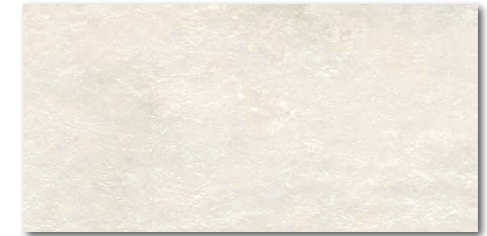

WARVK878
 ○ 500 l m²
 relief matt | structure matt



WARVN879
 ○ 750 l m²
 relief matt | structure matt
 color **owl**
 grau | grey



WARVK879
 ○ 500 l m²
 relief matt | structure matt



WARVN880
 ○ 750 l m²
 relief matt | structure matt
 color **elephant**
 dunkelgrau | dark grey



WARVK880
 ○ 500 l m²
 relief matt | structure matt

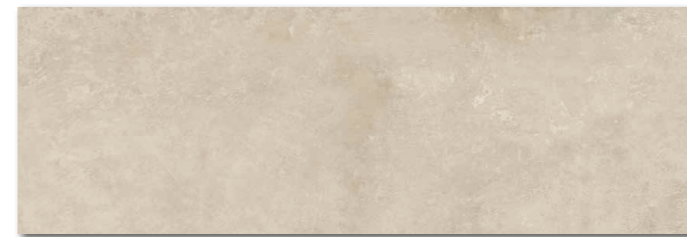

WARVN881
 ○ 750 l m²
 relief matt | structure matt
 color **suri**
 dunkelbeige | dark beige

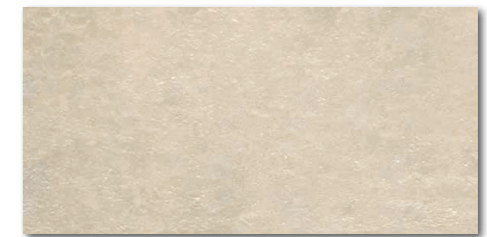

WARVK881
 ○ 500 l m²
 relief matt | structure matt

Produkt | product



Wandfliese wall tile	30x90	298x898-8	EN 14411 - L BIII	5	3,7	1,35	30	40,50	20,0	14,8	625
Wandfliese wall tile	30x60	298x598-8	EN 14411 - L BIII	8	5,56	1,44	40	57,60	21,3	14,8	876



60x120

R10/B

v3



DARV9878
 ○ 700 l m²
 relief matt | structure matt
 color **swan**
 weiß-grau | white-grey



DARV9879
 ○ 700 l m²
 relief matt | structure matt
 color **owl**
 grau | grey



60x120

R10/B

v3



DARV9880
 ○ 700 l m²
 relief matt | structure matt
 color **elephant**
 dunkelgrau | dark grey



DARV9881
 ○ 700 l m²
 relief matt | structure matt
 color **suri**
 dunkelbeige | dark beige



60x120



598x1198-9



EN 14411 - G B1a



2



1,4



1,44



30



43,20



29,3



20,4



905



60x60
R10/B
v3
R



DAR62878
○ 560 | m²
relief matt | structure matt



DAR62879
○ 560 | m²
relief matt | structure matt



DAR62880
○ 560 | m²
relief matt | structure matt



DAR62881
○ 560 | m²
relief matt | structure matt



60x60
R10/B
v3
R

30x60
v3
R



DARSR878
○ 540 | m²
relief matt | structure matt | R10/B

DAFSR878
○ 620 | m²
relief matt | structure matt | R11/B

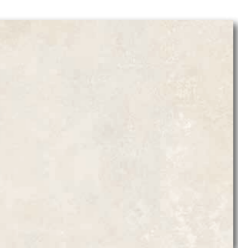

DAGSR878
○ 620 | m²
relief matt | structure matt | R11/C

DAESR878
○ 660 | m²
relief matt | structure matt | R12/B



DARSR879
○ 540 | m²
relief matt | structure matt | R10/B

DAFSR879
○ 620 | m²
relief matt | structure matt | R11/B



DAGSR879
○ 620 | m²
relief matt | structure matt | R11/C

DAESR879
○ 660 | m²
relief matt | structure matt | R12/B

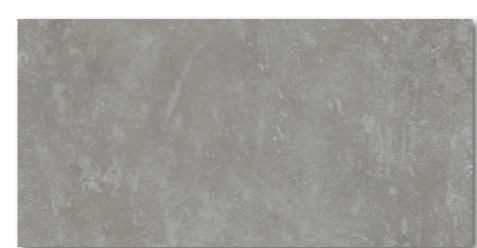

DARSR880
○ 540 | m²
relief matt | structure matt | R10/B

DAFSR880
○ 620 | m²
relief matt | structure matt | R11/B



DAGSR880
○ 620 | m²
relief matt | structure matt | R11/C

DAESR880
○ 660 | m²
relief matt | structure matt | R12/B



DARSR881
○ 540 | m²
relief matt | structure matt | R10/B

DAFSR881
○ 620 | m²
relief matt | structure matt | R11/B

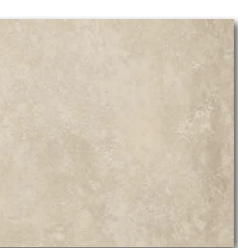

DAGSR881
○ 620 | m²
relief matt | structure matt | R11/C

DAESR881
○ 660 | m²
relief matt | structure matt | R12/B

30x30
v3

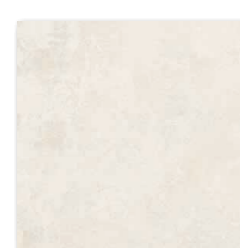

DAR34878
○ 390 | m²
relief matt | structure matt | R10/B

DAF34878
○ 430 | m²
relief matt | structure matt | R11/B

DAE34878
○ 450 | m²
relief matt | structure matt | R12/B

color **swan**
weiß-grau | white-grey



DAR34879
○ 390 | m²
relief matt | structure matt | R10/B

DAF34879
○ 430 | m²
relief matt | structure matt | R11/B

DAE34879
○ 450 | m²
relief matt | structure matt | R12/B

color **owl**
grau | grey



DAR34880
○ 390 | m²
relief matt | structure matt | R10/B

DAF34880
○ 430 | m²
relief matt | structure matt | R11/B

DAE34880
○ 450 | m²
relief matt | structure matt | R12/B

color **elephant**
dunkelgrau | dark grey



DAR34881
○ 390 | m²
relief matt | structure matt | R10/B

DAF34881
○ 430 | m²
relief matt | structure matt | R11/B

DAE34881
○ 450 | m²
relief matt | structure matt | R12/B

color **suri**
dunkelbeige | dark beige

Produkt product	cm	mm	EN	St/m ²	kg/m ²	kg/m ²	kg/m ²	kg/m ²	kg/m ²	kg/m ²	kg/m ²
Bodenfliese floor tile	60-60	598-598-9	EN 14411 - G Bla	4	2,8	1,44	32	46,08	29,1	20,2	955
Bodenfliese floor tile	30-60	298-598-9	EN 14411 - G Bla	7	5,6	1,26	40	50,40	24,2	19,2	993
Bodenfliese floor tile	30-30	298-298-8	EN 14411 - G Bla	13	11	1,18	48	56,64	20,5	17,4	1 011

30x30
v3



10x10
R10/B
v3
R



DAR11878 (SHEET)
900 | m²
relief matt | structure matt



DAR11879 (SHEET)
900 | m²
relief matt | structure matt



DAR11880 (SHEET)
900 | m²
relief matt | structure matt



DAR11881 (SHEET)
900 | m²
relief matt | structure matt

5x5 | 30x30

R10/B
v3
R



DDM05878 (SHEET)
300 | Netz
relief matt | structure matt
color **swan**
weiß-grau | white-grey



DDM05879 (SHEET)
300 | Netz
relief matt | structure matt
color **owl**
grau | grey



DDM05880 (SHEET)
300 | Netz
relief matt | structure matt
color **elephant**
dunkelgrau | dark grey



DDM05881 (SHEET)
300 | Netz
relief matt | structure matt
color **suri**
dunkelbeige | dark beige



30x120
R10/B
v3
R

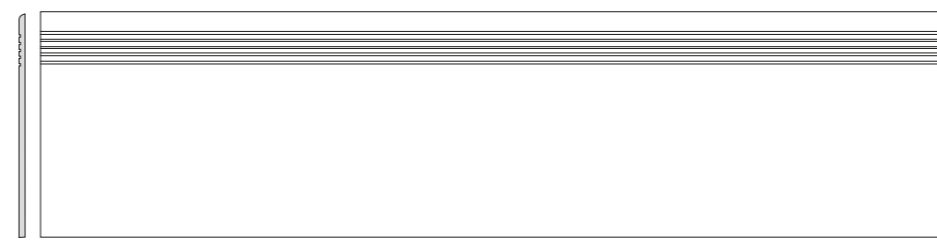

DCPVD878 color **swan** | weiß-grau | white-grey
DCPVD879 color **owl** | grau | grey
DCPVD880 color **elephant** | dunkelgrau | dark grey
DCPVD881 color **suri** | dunkelbeige | dark beige
740 | St
relief matt | structure matt

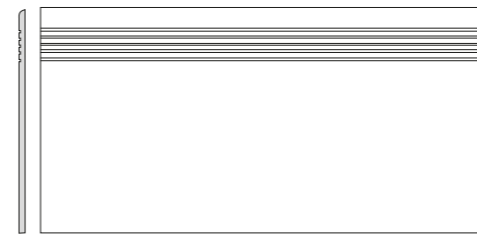

DCPSR878 color **swan** | weiß-grau | white-grey
DCPSR879 color **owl** | grau | grey
DCPSR880 color **elephant** | dunkelgrau | dark grey
DCPSR881 color **suri** | dunkelbeige | dark beige
270 | St
relief matt | structure matt

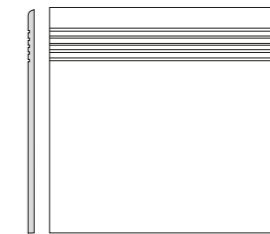

DCP34878 color **swan** | weiß-grau | white-grey
DCP34879 color **owl** | grau | grey
DCP34880 color **elephant** | dunkelgrau | dark grey
DCP34881 color **suri** | dunkelbeige | dark beige
150 | St
relief matt | structure matt



DSAS3878 color **swan** | weiß-grau | white-grey
DSAS3879 color **owl** | grau | grey
DSAS3880 color **elephant** | dunkelgrau | dark grey
DSAS3881 color **suri** | dunkelbeige | dark beige
180 | St
relief matt | structure matt



DSAJ8878 color **swan** | weiß-grau | white-grey
DSAJ8879 color **owl** | grau | grey
DSAJ8880 color **elephant** | dunkelgrau | dark grey
DSAJ8881 color **suri** | dunkelbeige | dark beige
110 | St
relief matt | structure matt



DSPJT878 color **swan** | weiß-grau | white-grey
DSPJT879 color **owl** | grau | grey
DSPJT880 color **elephant** | dunkelgrau | dark grey
DSPJT881 color **suri** | dunkelbeige | dark beige
200 | St
matt

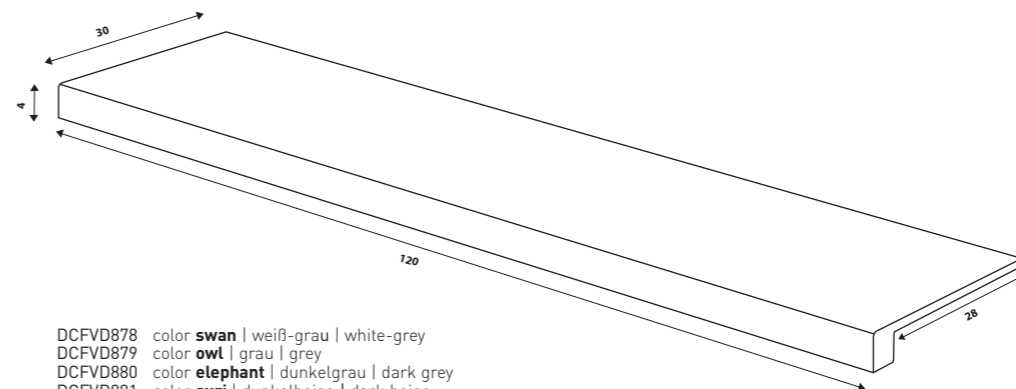

DCFVD878 color **swan** | weiß-grau | white-grey
DCFVD879 color **owl** | grau | grey
DCFVD880 color **elephant** | dunkelgrau | dark grey
DCFVD881 color **suri** | dunkelbeige | dark beige
1300 | St
relief matt | structure matt

News
30x60
30x30
R10/B
v3

60x7,2
30x7,2

30x11

30x120
R10/B
v3
R

News

RAKO Home

Produkt product	cm	mm	EN	St/m ²	St/m ²	kg/m ²	kg/m ²	kg/m ²	kg/m ²	kg/m ²	brutto kg
Bodenfliese floor tile	10-10	98-98-9	EN 14411 - G Bla	11	11	1,00	56	56,00	19,2	19,2	1 125
Mosaik sheet 30x30 cm mosaic sheet 30x30 cm	5x5	48-48-8	EN 14411 - G Bla	4	11	0,36	-	-	6,2	-	-
Stufe step tile	30x120	298-1198-9	EN 14411 - G Bla	3	2,8	1,08	-	-	22,5	-	-
Stufe step tile	30x60	298-598-9	EN 14411 - G Bla	5	5,6	0,90	-	-	17,3	-	-
Stufe step tile	30x30	298-298-8	EN 14411 - G Bla	13	11	1,18	52	-	20,5	17,4	-
Sockel skirting plinth	60x7,2	598-72-9	EN 14411 - G Bla	14	23,1	0,60	-	-	11,5	-	-
Sockel skirting plinth	30x7,2	298-72-8	EN 14411 - G Bla	30	46,3	0,65	-	-	11,3	17,4	-
Hohlkehlssockel cove skirting	30x11	298-110-8	STD No. 030 - 059824	35	30	1,17	-	-	19,3	16,5	-
Stufenformteil special step tile	30x120	298-1198-9	STD No. 030 - 059824	2	-	-	-	-	-	-	-

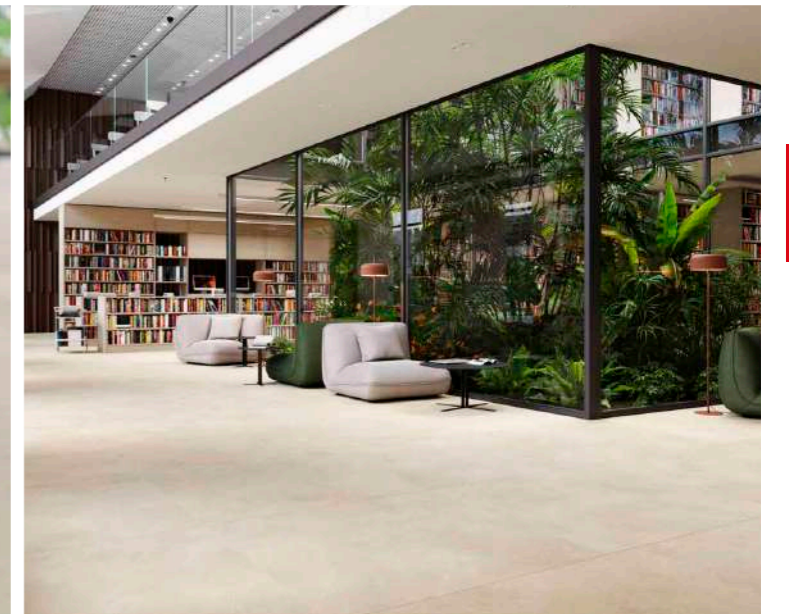
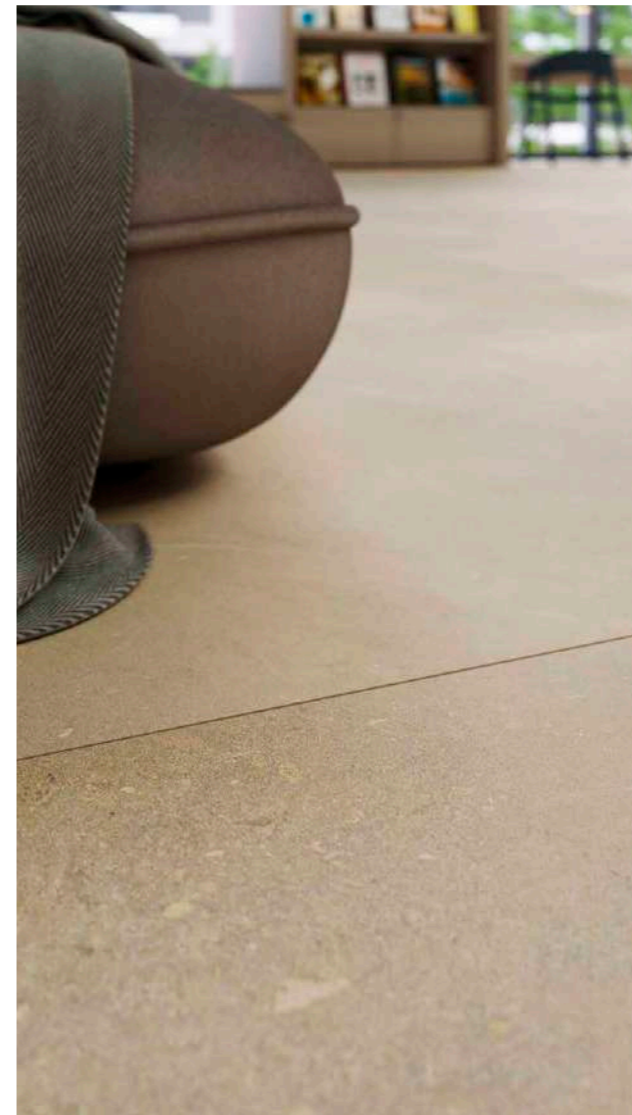
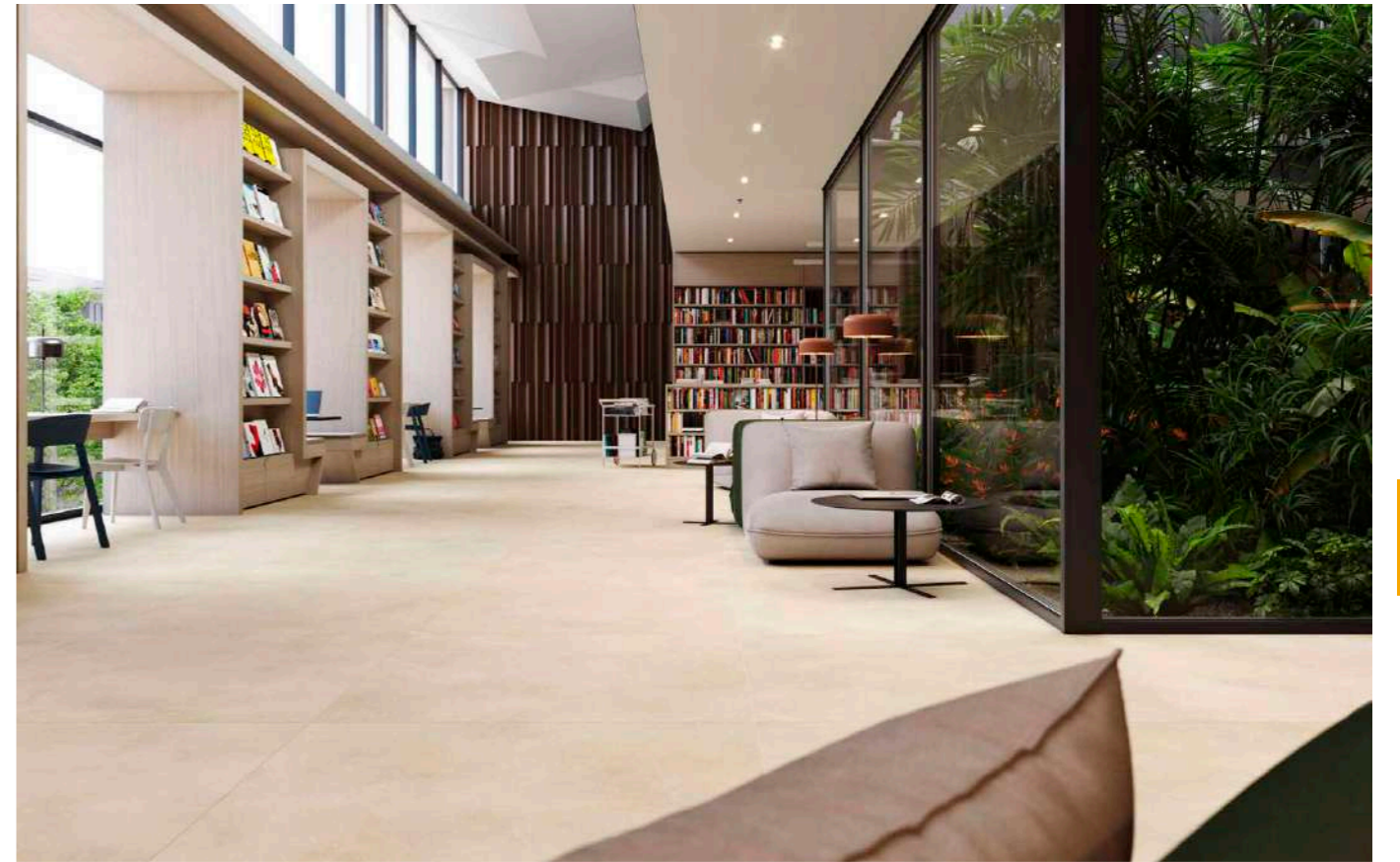

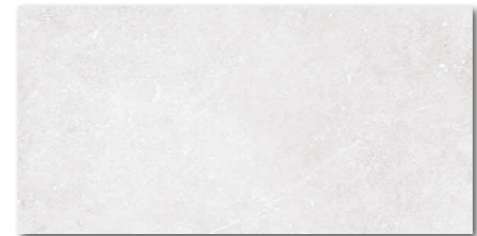

WAKVK882
○ 500 l m²
matt
color **mist**
hellgrau | light grey

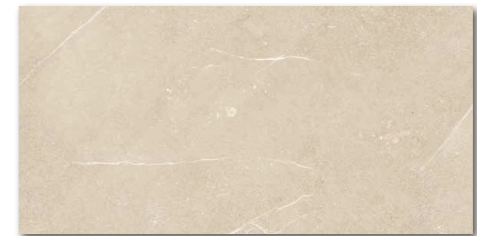

WAKVK885
○ 500 l m²
matt
color **divine**
beige | beige



WIKVK882
○ 500 l m²
matt
color **patch mist**
hellgrau | light grey



WIKVK885
○ 500 l m²
matt
color **patch divine**
beige | beige



Das Produkt zeigt die individuellen Designmöglichkeiten auf in jeder Verpackung. | This product is deliberately mixed in packing to include a random selection of designs.

Produkt product											
Wandfliese wall tile	30x60	298x598-8	EN 14411 - L BIII	8	5,56	1,44	40	57,60	21,3	14,8	876

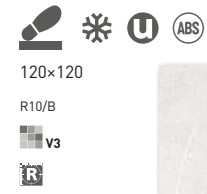

120x120

R10/B

v3

R



DAK92882
 ○ 900 l m²
 matt
 color **mist**
 hellgrau | light grey

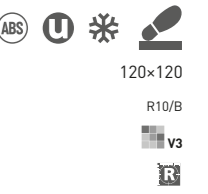

120x120

R10/B

v3

R



DAK92883
 ○ 900 l m²
 matt
 color **steam**
 grau | grey



DAK92884
 ○ 900 l m²
 matt
 color **smoke**
 dunkelgrau | dark grey



120-120



1198-1198-8,5



EN 14411 - G Bla



2



0,7



2,88



24



69,12



53,1



18,9



1 330



Produkt | product



120-120



1198-1198-8,5



EN 14411 - G Bla



2



0,7



2,88



24



69,12



53,1



18,9



1 330

Bodenfliese | floor tile



120x120

R10/B

v3

R

News

RAKO Home



DAK92885
 O 900 l m²
 matt
 color **divine**
 beige | beige



DAK92886
 O 900 l m²
 matt
 color **smog**
 braun | brown

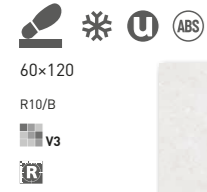

DAKV9882
 ○ 700 l m²
 matt
 color **mist**
 hellgrau | light grey



DAKV9883
 ○ 700 l m²
 matt
 color **steam**
 grau | grey



DAKV9884
 ○ 700 l m²
 matt
 color **smoke**
 dunkelgrau | dark grey

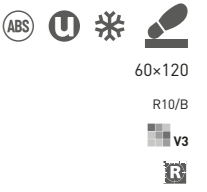

DAKV9885
 ○ 700 l m²
 matt
 color **divine**
 beige | beige



DAKV9886
 ○ 700 l m²
 matt
 color **smog**
 braun | brown

Produkt product													
Bodenfliese floor tile	60-120	598×1198×9	EN 14411 - G B1a	2	1,4	1,44	30	43,20	29,3	20,4	905		



80x80
R10/B
v3
R



DAK81882
○ 700 l m²
matt
color **mist**
hellgrau | light grey



80x80
R10/B
v3
R



DAK81883
○ 700 l m²
matt
color **steam**
grau | grey



DAK81884
○ 700 l m²
matt
color **smoke**
dunkelgrau | dark grey



DAK81885
○ 700 l m²
matt
color **divine**
beige | beige



DAK81886
○ 700 l m²
matt
color **smog**
braun | brown



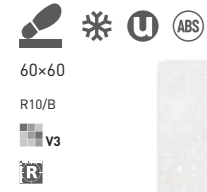

60x60
R10/B
v3
R



DAK62882
○ 560 l m²
matt

30x60
R10/B
v3
R



DAKSR882
○ 540 l m²
matt
color **mist**
hellgrau | light grey

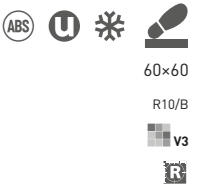

60x60
R10/B
v3
R



DAK62883
○ 560 l m²
matt



DAKSR883
○ 540 l m²
matt
color **steam**
grau | grey



DAK62884
○ 560 l m²
matt



DAKSR884
○ 540 l m²
matt
color **smoke**
dunkelgrau | dark grey



DAK62885
○ 560 l m²
matt

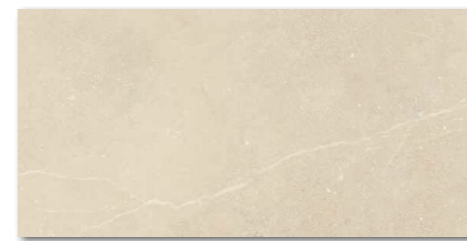

DAKSR885
○ 540 l m²
matt
color **divine**
beige | beige



DAK62886
○ 560 l m²
matt



DAKSR886
○ 540 l m²
matt
color **smog**
braun | brown

Produkt | product



Bodenfliese floor tile	60-60	598-598-9	EN 14411 - G B1a	4	2,8	1,44	32	46,08	29,1	20,2	955
Bodenfliese floor tile	30-60	298-598-9	EN 14411 - G B1a	7	5,6	1,26	40	50,40	24,2	19,2	993

30x60
R10/B
v3
R

60x60
R10/B
v3
R

30x60
R10/B
v3
R

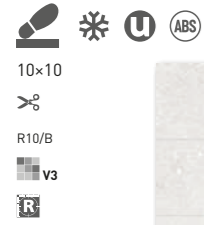

DAK11882 (SHEET)
 ○ 900 | m²
 matt
 color **mist**
 hellgrau | light grey



DAK11883 (SHEET)
 ○ 900 | m²
 matt
 color **steam**
 grau | grey



DAK11884 (SHEET)
 ○ 900 | m²
 matt
 color **smoke**
 dunkelgrau | dark grey



DAK11885 (SHEET)
 ○ 900 | m²
 matt
 color **divine**
 beige | beige



DAK11886 (SHEET)
 ○ 900 | m²
 matt
 color **smog**
 braun | brown



DDM05882 (SHEET)
 ○ 300 | Netz
 matt
 color **mist**
 hellgrau | light grey



DDM05883 (SHEET)
 ○ 300 | Netz
 matt
 color **steam**
 grau | grey

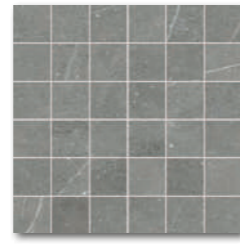

DDM05884 (SHEET)
 ○ 300 | Netz
 matt
 color **smoke**
 dunkelgrau | dark grey



DDM05885 (SHEET)
 ○ 300 | Netz
 matt
 color **divine**
 beige | beige



DDM05886 (SHEET)
 ○ 300 | Netz
 matt
 color **smog**
 braun | brown

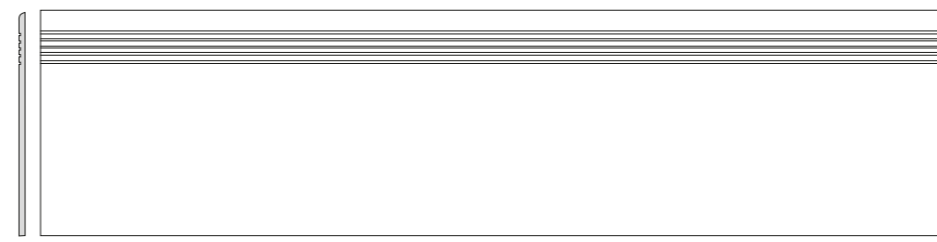
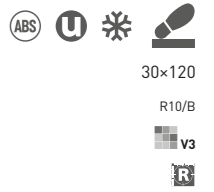

DCPVD882 color **mist** | hellgrau | light grey
 DCPVD883 color **steam** | grau | grey
 DCPVD884 color **smoke** | dunkelgrau | dark grey
 DCPVD885 color **divine** | beige | beige
 DCPVD886 color **smog** | braun | brown
 ○ 740 | St
 matt

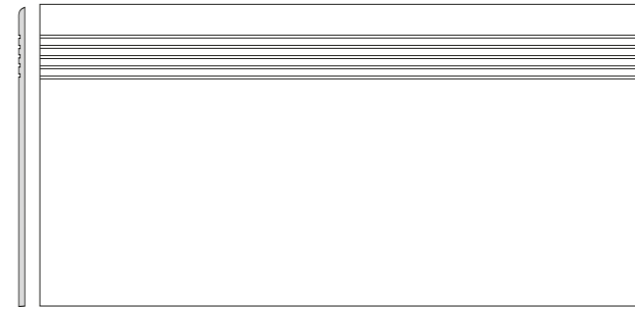

DCP84882 color **mist** | hellgrau | light grey
 DCP84883 color **steam** | grau | grey
 DCP84884 color **smoke** | dunkelgrau | dark grey
 DCP84885 color **divine** | beige | beige
 DCP84886 color **smog** | braun | brown
 ○ 380 | St
 matt

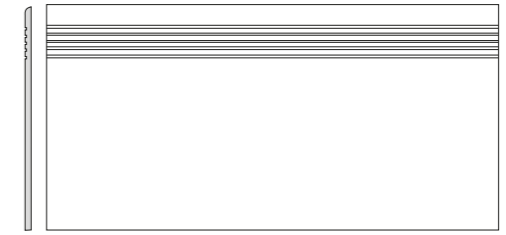

DCPSR882 color **mist** | hellgrau | light grey
 DCPSR883 color **steam** | grau | grey
 DCPSR884 color **smoke** | dunkelgrau | dark grey
 DCPSR885 color **divine** | beige | beige
 DCPSR886 color **smog** | braun | brown
 ○ 270 | St
 matt



DSA99882 color **mist** | hellgrau | light grey
 DSA99883 color **steam** | grau | grey
 DSA99884 color **smoke** | dunkelgrau | dark grey
 DSA99885 color **divine** | beige | beige
 DSA99886 color **smog** | braun | brown
 ○ 380 | St
 matt



DSA89882 color **mist** | hellgrau | light grey
 DSA89883 color **steam** | grau | grey
 DSA89884 color **smoke** | dunkelgrau | dark grey
 DSA89885 color **divine** | beige | beige
 DSA89886 color **smog** | braun | brown
 ○ 210 | St
 matt



DSAS3882 color **mist** | hellgrau | light grey
 DSAS3883 color **steam** | grau | grey
 DSAS3884 color **smoke** | dunkelgrau | dark grey
 DSAS3885 color **divine** | beige | beige
 DSAS3886 color **smog** | braun | brown
 ○ 180 | St
 matt

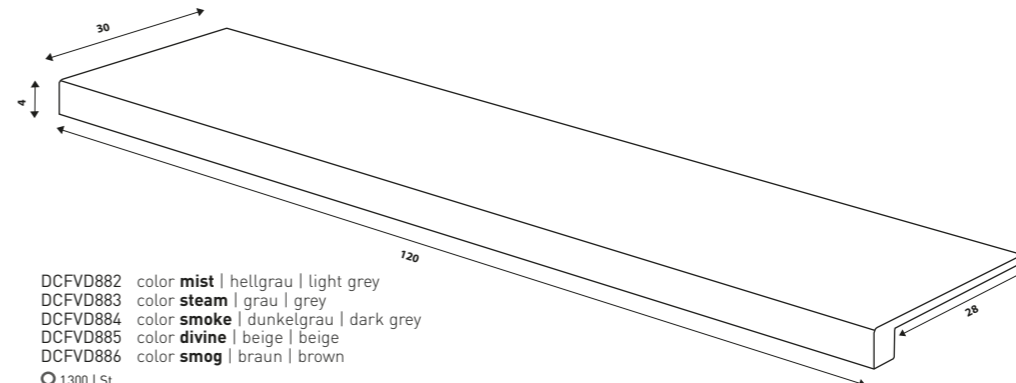

DCFVD882 color **mist** | hellgrau | light grey
 DCFVD883 color **steam** | grau | grey
 DCFVD884 color **smoke** | dunkelgrau | dark grey
 DCFVD885 color **divine** | beige | beige
 DCFVD886 color **smog** | braun | brown
 ○ 1300 | St
 matt

Produkt product	cm	mm	EN	Stim	m ²	kg	kg/m ²	kg	kg/m ²	kg	kg/m ²
Bodenfliese floor tile	10-10	98-98-9	EN 14411 - G Bla	11	11	1,00	56	56,00	29,1	20,2	955
Mosaik sheet 30x30 cm mosaic sheet 30x30 cm	5x5	48-48-9	EN 14411 - G Bla	3	11	0,27	-	-	5,2	-	-
Stufe step tile	30-120	298-1198-9	EN 14411 - G Bla	3	2,8	1,08	-	-	22,5	-	-
Stufe step tile	40-80	398-798-10	EN 14411 - G Bla	2	3,1	0,64	-	-	14,1	-	-
Stufe step tile	30-60	298-598-9	EN 14411 - G Bla	5	5,6	0,90	-	-	17,3	-	-
Socket skirting plinth	120-7,2	1198-72-9	EN 14411 - G Bla	11	11,9	0,93	-	-	20,4	-	-
Socket skirting plinth	80-9,5	798-95-10	EN 14411 - G Bla	10	13,2	0,76	-	-	16,7	21,9	-
Socket skirting plinth	60-7,2	598-72-9	EN 14411 - G Bla	14	23,1	0,60	-	-	11,5	-	-
Stufenformteil special step tile	30-120	298-1198-9	STD No. 030 - 059824	2	-	-	-	-	-	-	-





DASV9887
PEI 5 \bigcirc 700 l m²
matt



DAS81887
PEI 5 \bigcirc 700 l m²
matt



DAS62887
PEI 5 \bigcirc 560 l m²
matt
color **nature**
beige-grau | beige-grey



60x120
R10/B
v4
R

News

80x80
R10/B
v4
R

RAKO Home

60x60
R10/B
v4
R

Produkt product	cm	mm	EN	St/m ²	kg/m ²	kg/m ²	kg/m ²	kg/m ²	kg/m ²	kg/m ²	kg/m ²	kg/m ²
Bodenfliese floor tile	60x120	598-1198-9	EN 14411 - G Bla	2	1,4	1,44	30	43,20	29,3	20,4	905	
Bodenfliese floor tile	80x80	798-798-10	EN 14411 - G Bla	2	1,6	1,28	42	53,76	28,0	21,9	1.202	
Bodenfliese floor tile	60x60	598-598-9	EN 14411 - G Bla	4	2,8	1,44	32	46,08	29,1	20,2	955	



Die Fliesen der Serie zeichnen sich durch ein breites Farbspiel V4 aus. | All products of the entire batch show big deviations in shade difference V4.

Wir empfehlen, einzelne Fliesen aus mehreren Paketen herauszunehmen und den gesamten Bodenbelag nach der Inspirationsfotodokumentation in den Katalogen RAKO, eventuell den Webseiten www.rako.eu, zu komponieren. Wünschenswert ist die Kombination aller Fliesendesigns einschließlich ihrer Drehung um 90° oder 180°, sodass ausgewogene Optik der verlegten Fläche erzielt wird.

Before laying the tiles, we suggest you select from several cartons and arrange them as illustrated in the inspiration photo documentation in RAKO catalogues or website www.rako.eu, and mix the tiles to achieve the required result including turning them by 90° or 180°.

Produkt product	cm	mm	EN	St/m²	kg/m²	kg	kg	kg	kg	kg	kg
Bodenfliese floor tile	20x20	197x197-9	EN 14411 - G Bla	25	25	1,00	57	57,00	29,1	20,2	955
Mosaik sheet 30x30 cm mosaic sheet 30x30 cm	5x5	48x48-9	EN 14411 - G Bla	3	11	0,27	-	-	-	-	-
Stufe step tile	30x120	298x1198-9	EN 14411 - G Bla	3	2,8	1,08	-	-	22,5	-	-
Stufe step tile	40x80	398x798-10	EN 14411 - G Bla	2	3,1	0,64	-	-	14,1	-	-
Stufe step tile	60x60	598x597-9	EN 14411 - G Bla	3	2,8	1,08	-	-	21,9	-	-
Socket skirting plinth	80x9,5	798-95-10	EN 14411 - G Bla	10	13,2	0,76	-	-	16,7	21,9	-
Socket skirting plinth	60x7,2	598-72-9	EN 14411 - G Bla	14	23,1	0,60	-	-	11,5	-	-
Stufenformteil special step tile	30x120	298x1198-9	STD No. 030 - 059824	2	-	-	-	-	-	-	-



20x20
5x5 | 30x30
R10/B
v4
R



DAK25887
PEI 5 ○ 780 | m²
matt



DDM05887 (SHEET)
PEI 5 ○ 300 | Netz
matt | >=

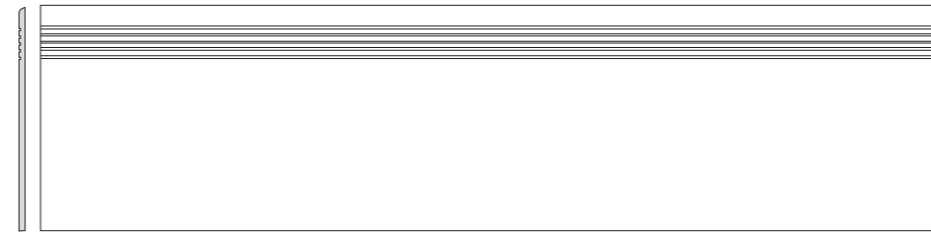

DCPVD887
PEI 5 ○ 740 | St
matt



DCP84887
PEI 5 ○ 380 | St
matt



DCP62887
PEI 5 ○ 370 | St
matt

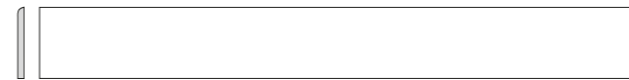

DSA89887
○ 210 | St
matt



DSAS3887
○ 180 | St
matt

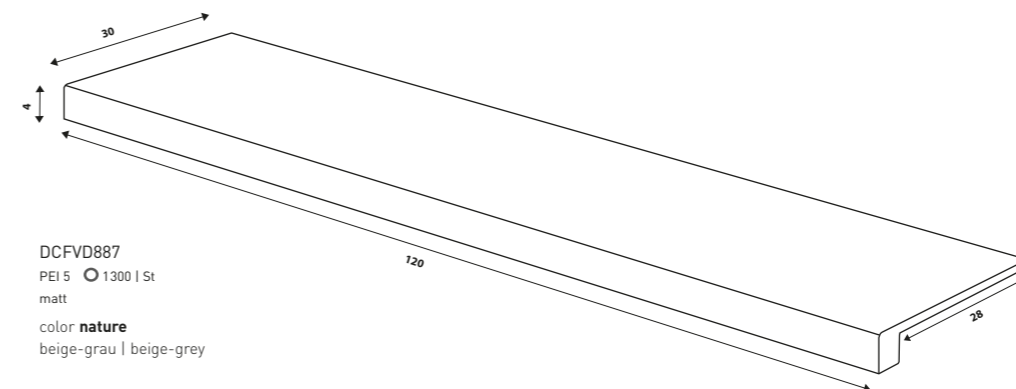

DCFVD887
PEI 5 ○ 1300 | St
matt
color **nature**
beige-grau | beige-grey

30x120
R10/B
v4
R

40x80
60x60
R10/B
v4
R

80x9,5
60x7,2
R

30x120
R10/B
v4
R

News

RAKO Home



DAKV6887
PEI 5 ○ 850 l m²
matt



DAK66887
PEI 5 ○ 760 l m²
matt

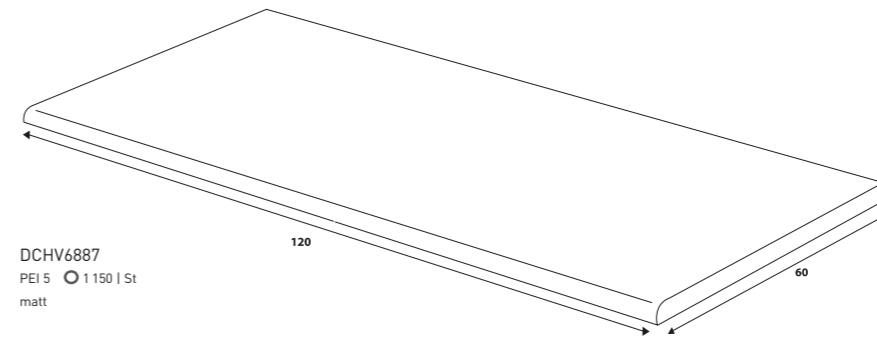

DCHV6887
PEI 5 ○ 1 150 l St
matt

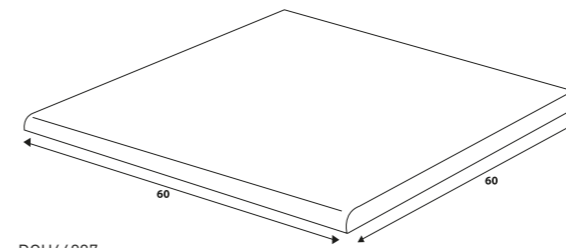

DCH66887
PEI 5 ○ 780 l St
matt
color **nature**
beige-grau | beige-grey



60x120
R11/B
v4
R4
20mm

News



60x60
R11/B
v4
R4
20mm

RAKO Home

Produkt product	cm	mm	EN	St	St	St	St	St	St	kg	kg
Bodenfliese floor tile	60x120	598x1198x20	EN 14411 - G Bla	1	1,4	0,72	30	21,60	32,5	45,1	999
Bodenfliese floor tile	60x60	598x598x20	EN 14411 - G Bla	2	2,8	0,72	30	21,60	32,5	45,1	999
Stufe step tile	60x120	598x1198x20	EN 14411 - G Bla	1	-	-	-	-	32,5	-	-
Stufe step tile	60x60	598x598x20	EN 14411 - G Bla	2	-	-	-	-	32,5	-	-



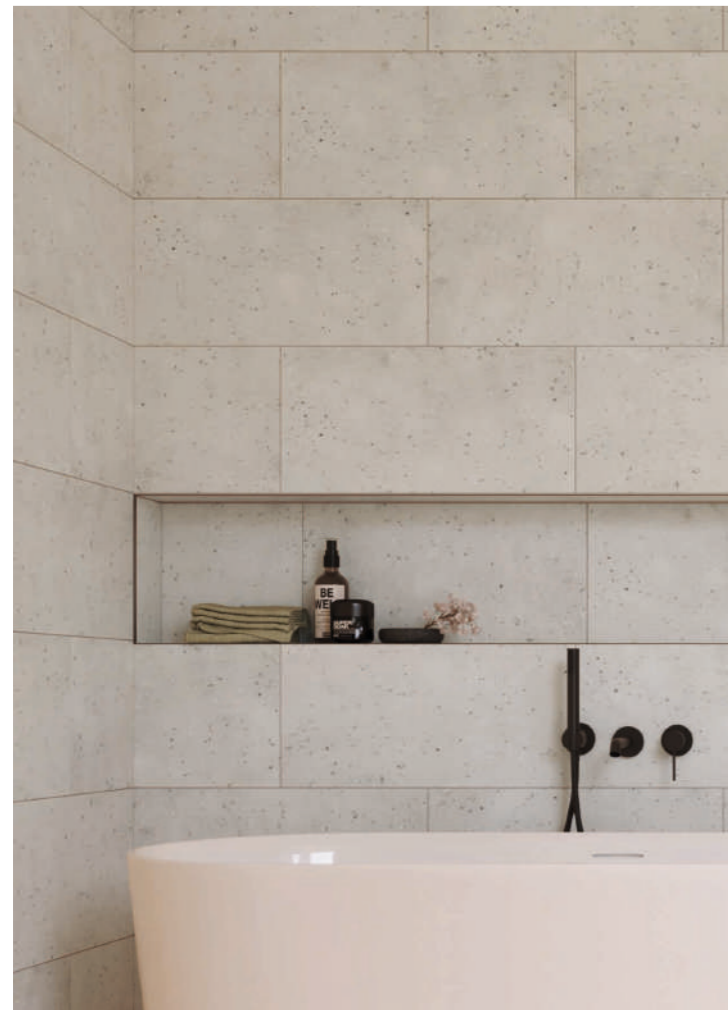

WARVK203
 ○ 500 l m²
 relief matt | structure matt

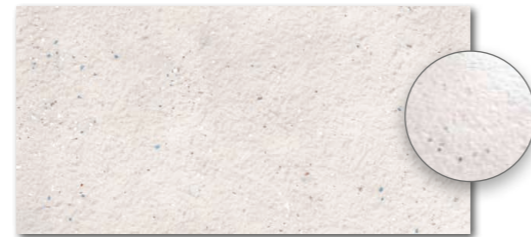

WBRVK203
 ○ 500 l m²
 relief matt | structure matt
 color **smoothie**
 hellbeige | light beige

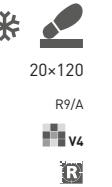

DARVE896
 PEI 5 ○ 820 l m²
 relief matt | structure matt



DAR82896
 PEI 5 ○ 610 l m²
 relief matt | structure matt
 color **bloom**
 beige | beige



DARVE897
 PEI 4 ○ 820 l m²
 relief matt | structure matt



DAR82897
 PEI 4 ○ 610 l m²
 relief matt | structure matt
 color **nut**
 beige-braun | beige-brown



DARVE898
 PEI 4 ○ 820 l m²
 relief matt | structure matt

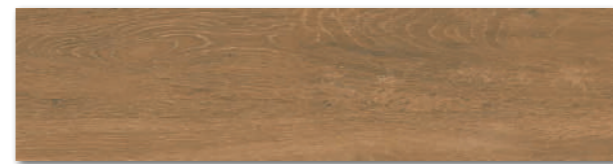

DAR82898
 PEI 4 ○ 610 l m²
 relief matt | structure matt
 color **bark**
 braun | brown

20x120
 R9/A
 v4
 R

20x80
 R9/A
 v4
 R

20x120
 R9/A
 v4
 R

20x80
 R9/A
 v4
 R

20x120
 R9/A
 v4
 R

20x80
 R9/A
 v4
 R

News

RAKO Home

Produkt product	cm	mm	EN	St/m ²	kg/m ²	kg	kg	kg	kg	kg	kg
Wandfliese wall tile	30x60	298x598x8	EN 14411 - L BIII	8	5,56	1,44	40	57,60	21,3	14,8	876
Bodenfliese floor tile	20x120	198x1198x9	EN 14411 - G BIIa	4	4,2	0,96	32	30,72	19,6	20,4	651
Bodenfliese floor tile	20x80	197x798x10	EN 14411 - G BIIa	4	6,25	0,64	72	46,08	14,0	21,9	1 034



Die Fliesen der Serie zeichnen sich durch ein breites Farbspiel V4 aus. | All products of the entire batch show big deviations in shade difference V4.

Wir empfehlen, einzelne Fliesen aus mehreren Paketen herauszunehmen und den gesamten Bodenbelag nach der Inspirationsfotodokumentation in den Katalogen RAKO, eventuell den Webseiten www.rako.eu, zu komponieren. Wünschenswert ist die Kombination aller Fliesendesigns einschließlich ihrer Drehung um 180°, sodass ausgewogene Optik der verlegten Fläche erzielt wird.

Before laying the tiles, we suggest you select from several cartons and arrange them as illustrated in the inspiration photo documentation in RAKO catalogues or website www.rako.eu, and mix the tiles to achieve the required result including turning them by 180°.

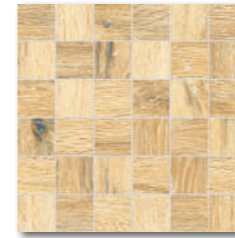

DDM05896 (SHEET)
PEI 5 ○ 300 | Netz
relief matt | structure matt
color **bloom**
beige | beige



DDM05897 (SHEET)
PEI 4 ○ 300 | Netz
relief matt | structure matt
color **nut**
beige-braun | beige-brown



DDM05898 (SHEET)
PEI 4 ○ 300 | Netz
relief matt | structure matt
color **bark**
braun | brown

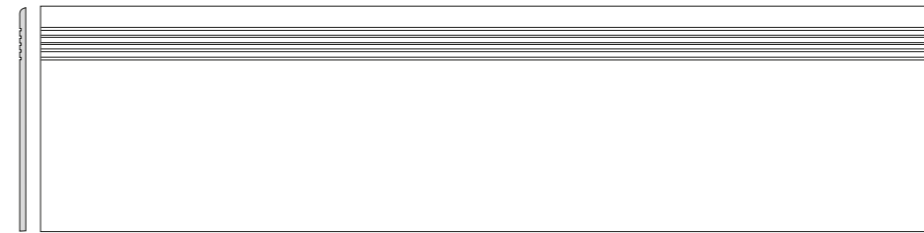

DCPVD896 color **bloom** | beige | beige
DCPVD897 color **nut** | beige-braun | beige-brown
DCPVD898 color **bark** | braun | brown
PEI 4-5 ○ 740 | St
relief matt | structure matt

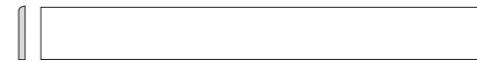

DSAS3896 color **bloom** | beige | beige
DSAS3897 color **nut** | beige-braun | beige-brown
DSAS3898 color **bark** | braun | brown
○ 180 | St
relief matt | structure matt

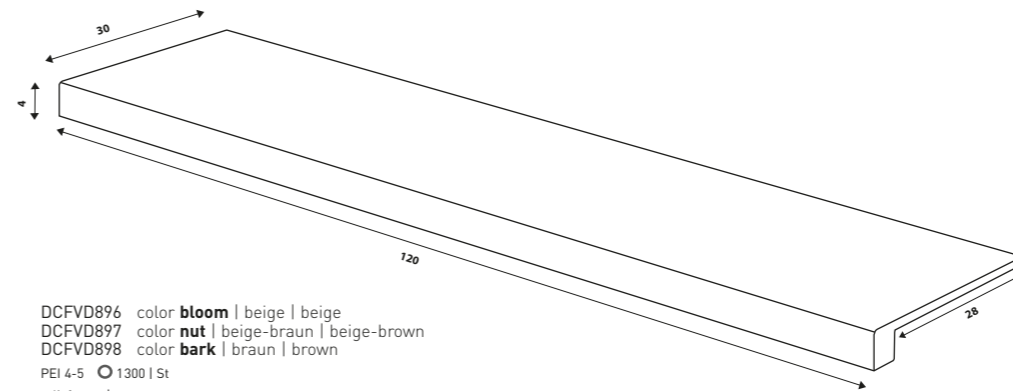

DCFVD896 color **bloom** | beige | beige
DCFVD897 color **nut** | beige-braun | beige-brown
DCFVD898 color **bark** | braun | brown
PEI 4-5 ○ 1300 | St
relief matt | structure matt



Produkt product	cm	mm	EN	St/m ²	kg/m ²	kg/m ³	kg/m ²	kg/m ²	kg/m ²	kg/m ²	kg/m ²
Mosaik sheet 30x30 cm mosaic sheet 30x30 cm	5x5	48x48x9	EN 14411 - G Bla	3	11	0,27	-	-	5,2	-	-
Stufe step tile	30x120	298x1198x9	EN 14411 - G Bla	3	2,8	1,08	-	-	22,5	-	-
Sockel skirting plinth	60x7,2	598x72x9	EN 14411 - G Bla	14	23,1	0,60	-	-	11,5	-	-
Stufenformteil special step tile	30x120	298x1198x9	STO No. 030 - 059824	2	-	-	-	-	-	-	-

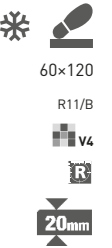

DAKV6896
PEI 5 ○ 850 l m²
matt
color **bloom**
beige | beige



DAKV6897
PEI 4 ○ 850 l m²
matt
color **nut**
beige-braun | beige-brown



DAKV6898
PEI 4 ○ 850 l m²
matt
color **bark**
braun | brown

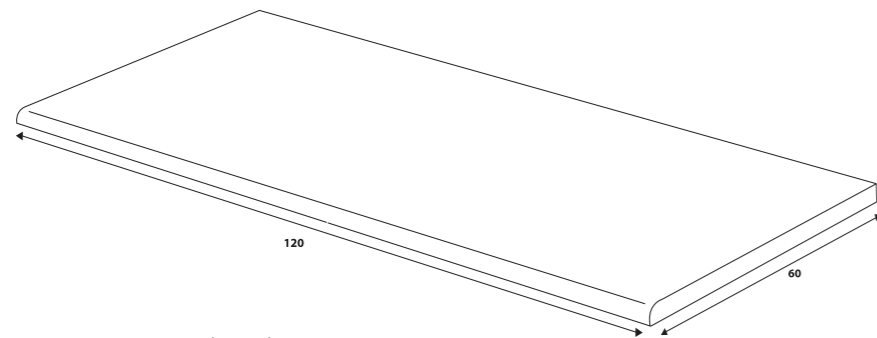

DCHV6896 color **bloom** | beige | beige
DCHV6897 color **nut** | beige-braun | beige-brown
DCHV6898 color **bark** | braun | brown
PEI 4-5 ○ 1150 l St
matt

Produkt | product



Bodenfliese floor tile	60x120	598x1198x20	EN 14411 - G Bla	1	1,4	0,72	30	21,60	32,5	45,1	999
Stufe step tile	60x120	598x1198x20	EN 14411 - G Bla	1	-	-	-	-	32,5	-	-



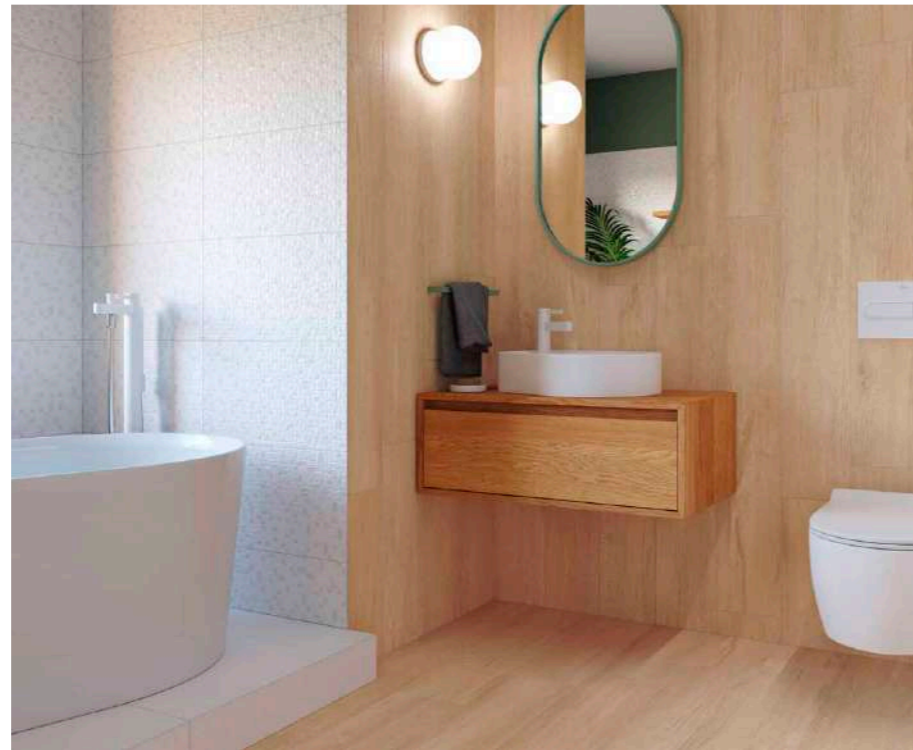

WARVN527
 ○ 750 l m²
 relief mattglänzend | structure mattglossy
 color **snow**
 weiß | white



DARVE893
 PEI 5 ○ 820 l m²
 relief matt | structure matt
 color **feather**
 hellgrau | light grey

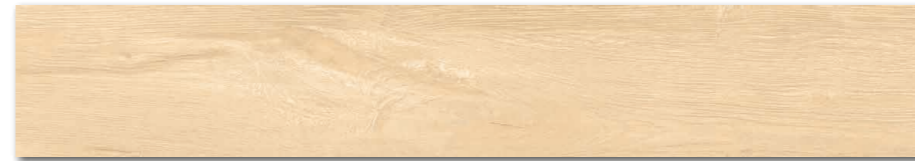

DARVE894
 PEI 4 ○ 820 l m²
 relief matt | structure matt
 color **mid**
 beige | beige

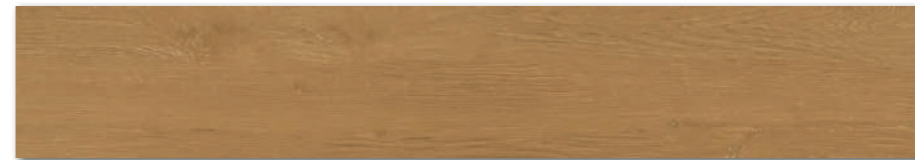

DARVE895
 PEI 4 ○ 820 l m²
 relief matt | structure matt
 color **heavy**
 braun | brown



30x90



20x120

R9/A



News

RAKO Home

Produkt | product



30x90



298-898-8
 198-1198-9



EN 14411 - L BIII
 EN 14411 - G BIIa



5



3,7



1,35



30



40,50



20,0



14,8



625

Wandfliese | wall tile
 Bodenfliese | floor tile

4

4,2

0,96

32

30,72

19,6

20,4

651

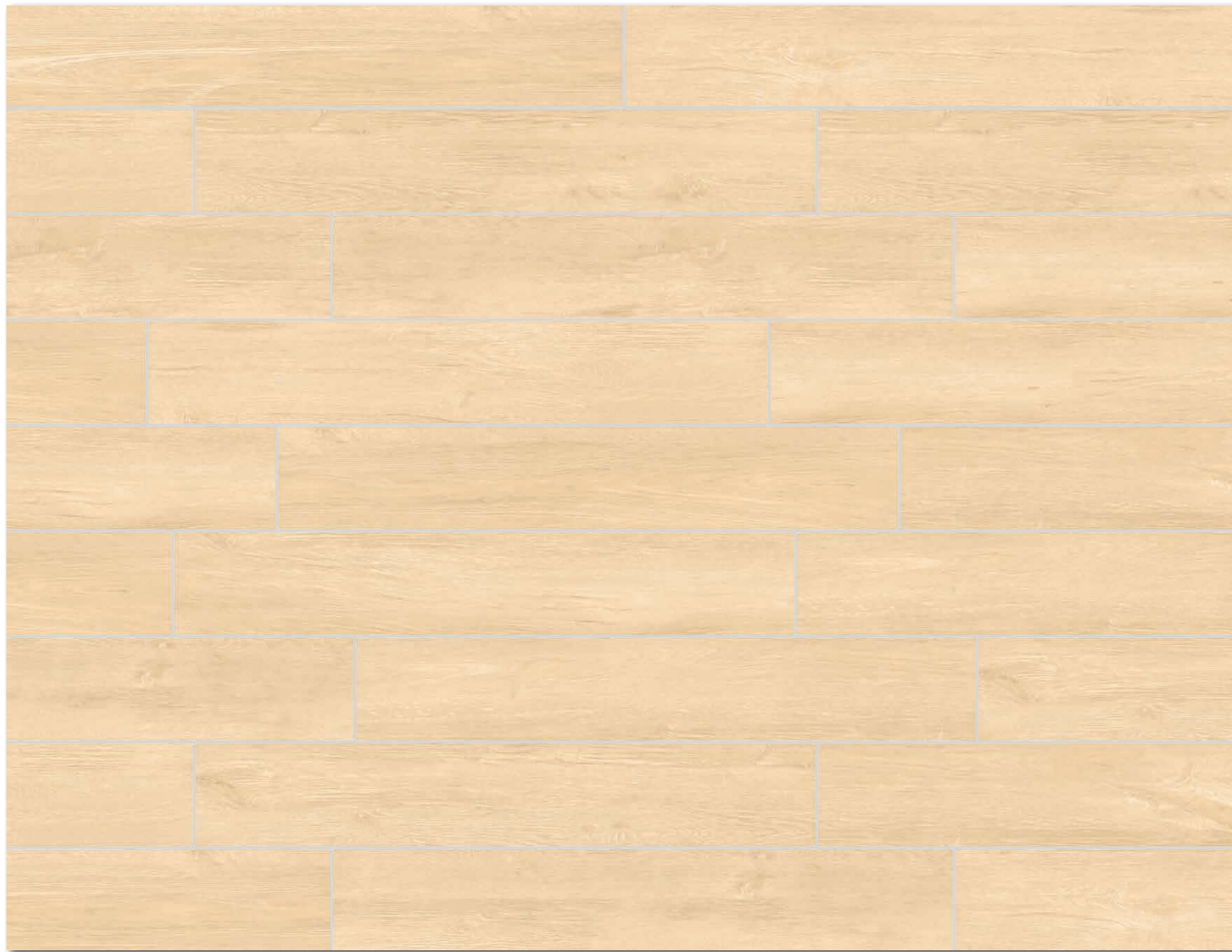

Die Fliesen der Serie zeichnen sich durch ein breites Farbspiel V3 aus. | All products of the entire batch show big deviations in shade difference V3.

Wir empfehlen, einzelne Fliesen aus mehreren Paketen herauszunehmen und den gesamten Bodenbelag nach der Inspirationsfotodokumentation in den Katalogen RAKO, eventuell den Webseiten www.rako.eu, zu komponieren. Wünschenswert ist die Kombination aller Fliesendesigns einschließlich ihrer Drehung um 180°, sodass ausgewogene Optik der verlegten Fläche erzielt wird.

Before laying the tiles, we suggest you select from several cartons and arrange them as illustrated in the inspiration photo documentation in RAKO catalogues or website www.rako.eu, and mix the tiles to achieve the required result including turning them by 180°.



DDM05893 (SHEET)
PEI 5 \odot 300 | Netz
relief matt | structure matt
color **feather**
hellgrau | light grey



DDM05894 (SHEET)
PEI 4 \odot 300 | Netz
relief matt | structure matt
color **mid**
beige | beige



DDM05895 (SHEET)
PEI 4 \odot 300 | Netz
relief matt | structure matt
color **heavy**
braun | brown

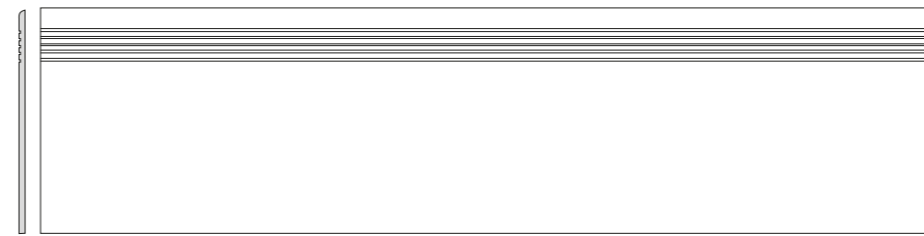

DCPVD893 color **feather** | hellgrau | light grey
DCPVD894 color **mid** | beige | beige
DCPVD895 color **heavy** | braun | brown
PEI 4-5 \odot 740 | St
relief matt | structure matt



DSAS3893 color **feather** | hellgrau | light grey
DSAS3894 color **mid** | beige | beige
DSAS3895 color **heavy** | braun | brown
 \odot 180 | St
relief matt | structure matt

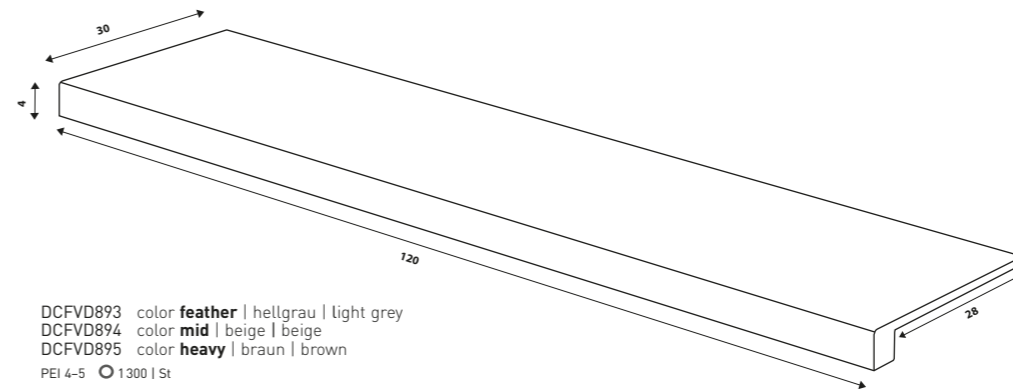

DCFVD893 color **feather** | hellgrau | light grey
DCFVD894 color **mid** | beige | beige
DCFVD895 color **heavy** | braun | brown
PEI 4-5 \odot 1300 | St
relief matt | structure matt

5x5 | 30x30



R10/B

v3



30x120

R9/A

v3



60x7,2



30x120

R9/A

v3



Produkt | product



Produkt product	cm	mm	EN	St/m ²	kg/m ²	kg	kg	kg	kg	kg	kg
Mosaik sheet 30x30 cm mosaic sheet 30x30 cm	5x5	48x48x9	EN 14411 - G Bla	3	11	0,27	-	-	5,2	-	-
Stufe step tile	30x120	298x1198x9	EN 14411 - G Bla	3	2,8	1,08	-	-	22,5	-	-
Socket skirting plinth	60x7,2	598x72x9	EN 14411 - G Bla	14	23,1	0,60	-	-	11,5	-	-
Stufenformteil special step tile	30x120	298x1198x9	STD No. 030 - 059824	2	-	-	-	-	-	-	-





120x120

R10/B

v3



DAK92901
PEI 5 ○ 900 l m²
matt
color **malt**
beige | beige



120x120

R10/B

v3



DAK92899
PEI 5 ○ 900 l m²
matt
color **rice**
weiß-grau | white-grey



DAK92900
PEI 4 ○ 900 l m²
matt
color **grit**
grau | grey

Produkt | product



120x120



1198x1198x8,5



EN 14411 - G Bla



2



0,7



2,88



24



69,12



53,1



18,9



1330

Bodenfliese | floor tile



60x120

R10/B

v3



DAKV9901
PEI 5 ○ 700 | m²
matt
color **malt**
beige | beige



DAKV9899
PEI 5 ○ 700 | m²
matt
color **rice**
weiß-grau | white-grey

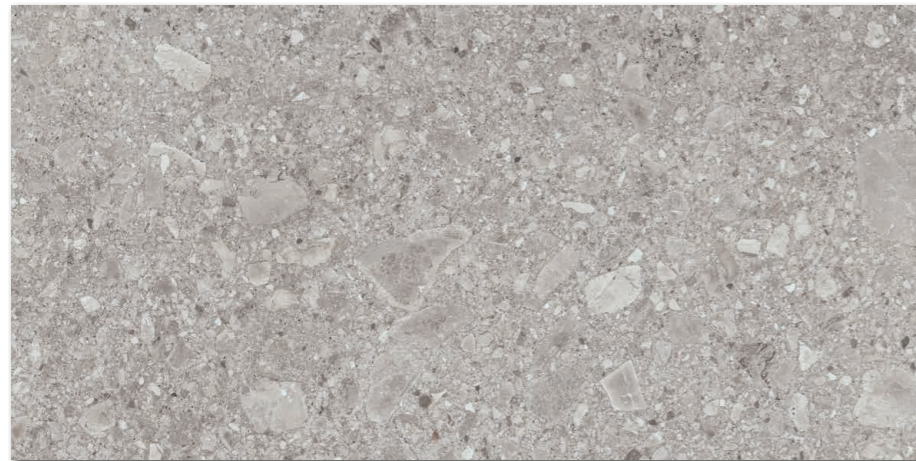

DAKV9900
PEI 4 ○ 700 | m²
matt
color **grit**
grau | grey



60x60
5x5 | 30x30

R10/B

v3



DAK62901
PEI 5 ○ 560 | m²
matt
color **malt**
beige | beige



DAK62899
PEI 5 ○ 560 | m²
matt
color **rice**
weiß-grau | white-grey



DAK62900
PEI 4 ○ 560 | m²
matt
color **grit**
grau | grey



DDM05901 (SHEET)
PEI 5 ○ 300 | Netz
matt | >%



DDM05899 (SHEET)
PEI 5 ○ 300 | Netz
matt | >%

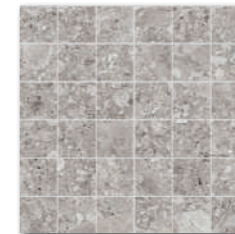

DDM05900 (SHEET)
PEI 4 ○ 300 | Netz
matt | >%

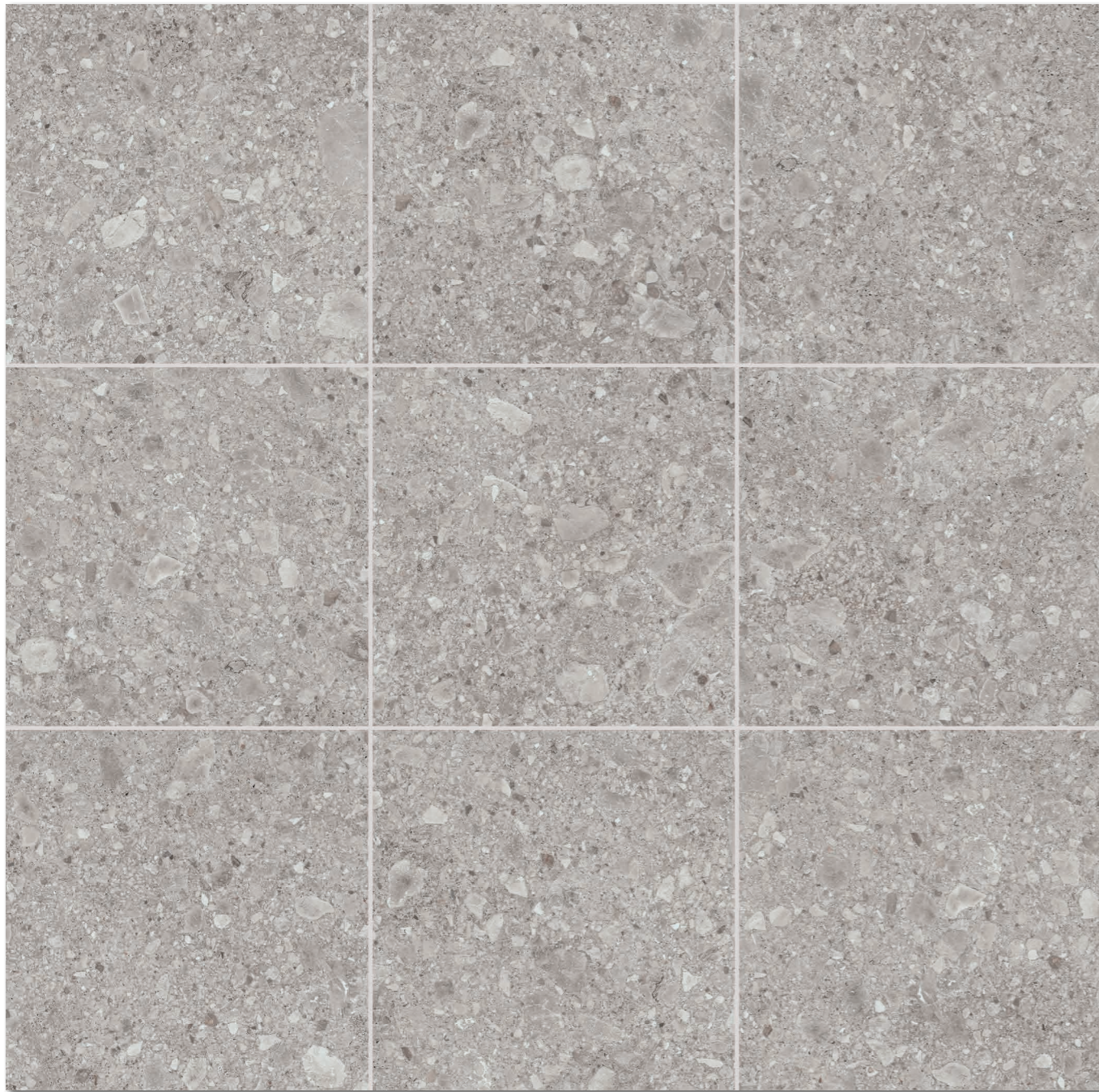

Die Fliesen der Serie zeichnen sich durch ein breites Farbspiel V3 aus. | All products of the entire batch show big deviations in shade difference V3.

Wir empfehlen, einzelne Fliesen aus mehreren Paketen herauszunehmen und den gesamten Bodenbelag nach der Inspirationsfotodokumentation in den Katalogen RAKO, eventuell den Webseiten www.rako.eu, zu komponieren. Wünschenswert ist die Kombination aller Fliesendesigns einschließlich ihrer Drehung um 90° oder 180°, sodass ausgewogene Optik der verlegten Fläche erzielt wird.

Before laying the tiles, we suggest you select from several cartons and arrange them as illustrated in the inspiration photo documentation in RAKO catalogues or website www.rako.eu, and mix the tiles to achieve the required result including turning them by 90° or 180°.

Produkt product	cm	mm	EN	St/m²	kg/m²	kg/m²	kg/m²	kg/m²	kg/m²	kg/m²	kg/m²
Bodenfliese floor tile	60x120	598x1198-9	EN 14411 - G Bla	2	1,4	1,44	30	43,20	29,3	20,4	905
Bodenfliese floor tile	60x60	598x598-9	EN 14411 - G Bla	4	2,8	1,44	32	46,08	29,1	20,2	955
Mosaik sheet 30x30 cm mosaic sheet 30x30 cm	5x5	48x48-9	EN 14411 - G Bla	3	11	0,27	-	-	-	-	-
Stufe step tile	30x120	298x1198-9	EN 14411 - G Bla	3	2,8	1,08	-	-	22,5	-	-
Stufe step tile	60x60	598x597-9	EN 14411 - G Bla	3	2,8	1,08	-	-	21,9	-	-
Socket skirting plinth	120x7,2	1198x72-9	EN 14411 - G Bla	11	11,9	0,93	-	-	20,4	-	-
Socket skirting plinth	60x7,2	598x72-9	EN 14411 - G Bla	14	23,1	0,60	-	-	11,5	-	-
Stufenformteil special step tile	30x120	298x1198-9	STD No. 030 - 059824	2	-	-	-	-	-	-	-

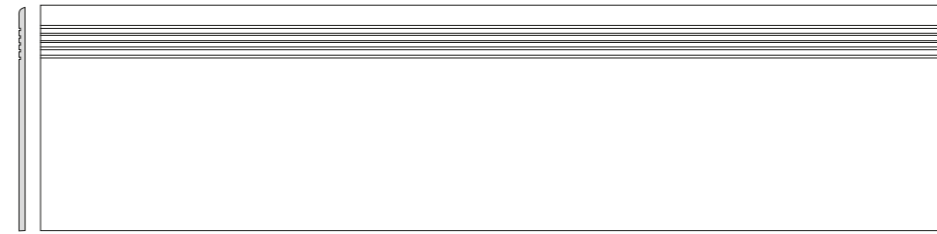
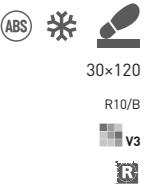

DCPVD899 color **rice** | weiß-grau | white-grey
 DCPVD900 color **grit** | grau | grey
 DCPVD901 color **malt** | beige | beige
 PEI 4-5 ○ 740 | St
 matt



DCP62899 color **rice** | weiß-grau | white-grey
 DCP62900 color **grit** | grau | grey
 DCP62901 color **malt** | beige | beige
 PEI 4-5 ○ 370 | St
 matt



DSAS3899 color **rice** | weiß-grau | white-grey
 DSAS3900 color **grit** | grau | grey
 DSAS3901 color **malt** | beige | beige
 ○ 180 | St
 matt



DSA99899 color **rice** | weiß-grau | white-grey
 DSA99900 color **grit** | grau | grey
 DSA99901 color **malt** | beige | beige
 ○ 380 | St
 matt

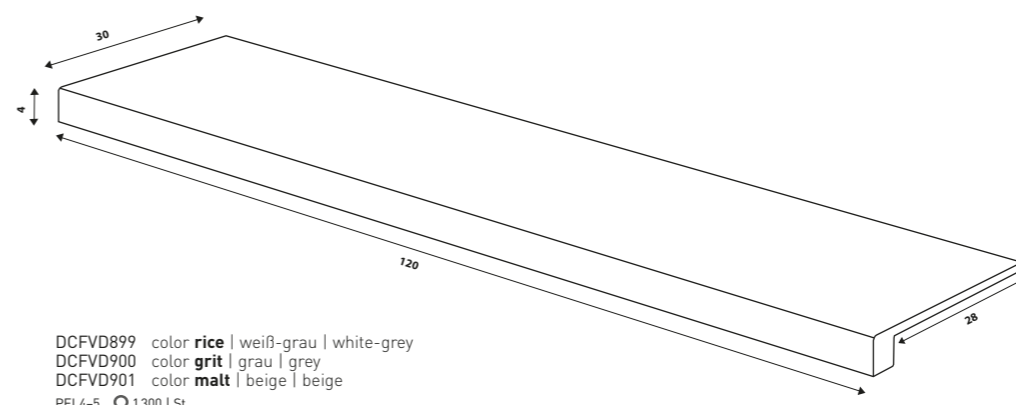

DCFVD899 color **rice** | weiß-grau | white-grey
 DCFVD900 color **grit** | grau | grey
 DCFVD901 color **malt** | beige | beige
 PEI 4-5 ○ 1300 | St
 matt

30x120
R10/B
V3
R

60x60
R10/B
V3
R

60x7,2
R

120x7,2
R

30x120
R10/B
V3
R

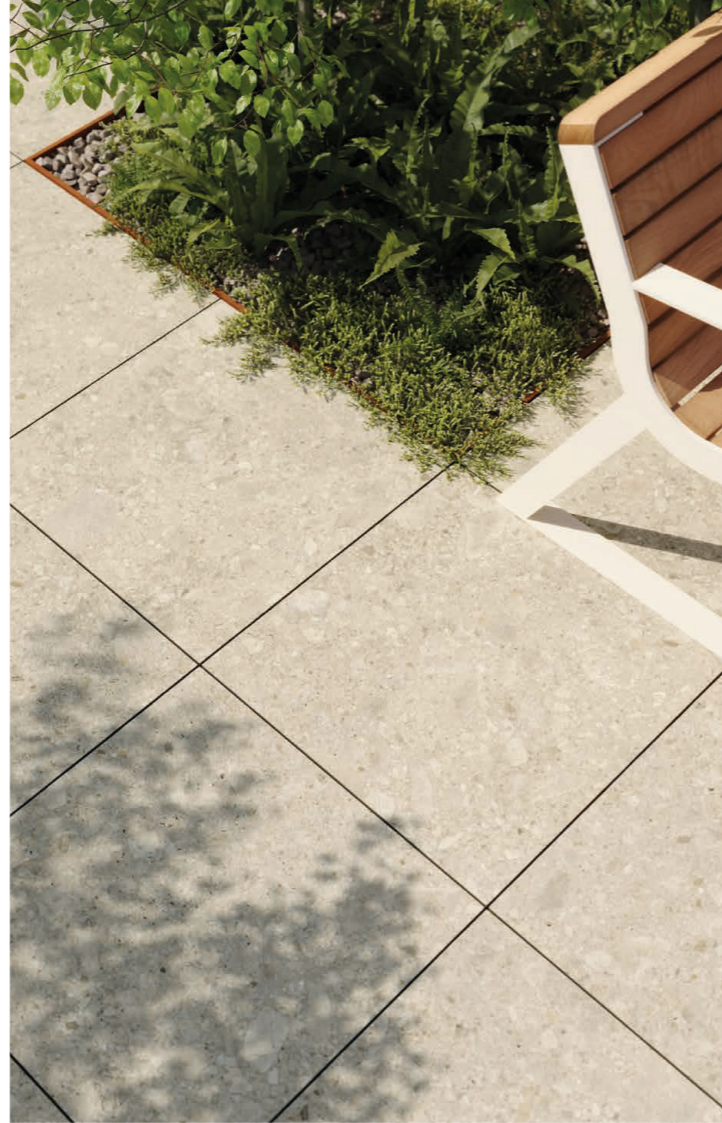

DAK66901
PEI 5 ○ 760 l m²
matt
color **malt**
beige | beige



DAK66899
PEI 5 ○ 760 l m²
matt
color **rice**
weiß-grau | white-grey



DAK66900
PEI 4 ○ 760 l m²
matt
color **grit**
grau | grey

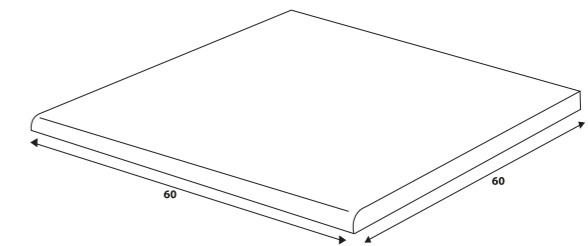

DCH66899 color **rice** | weiß-grau | white-grey
DCH66900 color **grit** | grau | grey
DCH66901 color **malt** | beige | beige
PEI 4-5 ○ 780 l St
matt

Produkt | product



Bodenfliese floor tile	60-60	598-598-20	EN 14411 - G Bla	2	2,8	0,72	30	21,60	32,5	45,1	999
Stufe step tile	60-60	598-598-20	EN 14411 - G Bla	2	-	-	-	-	32,5	-	-

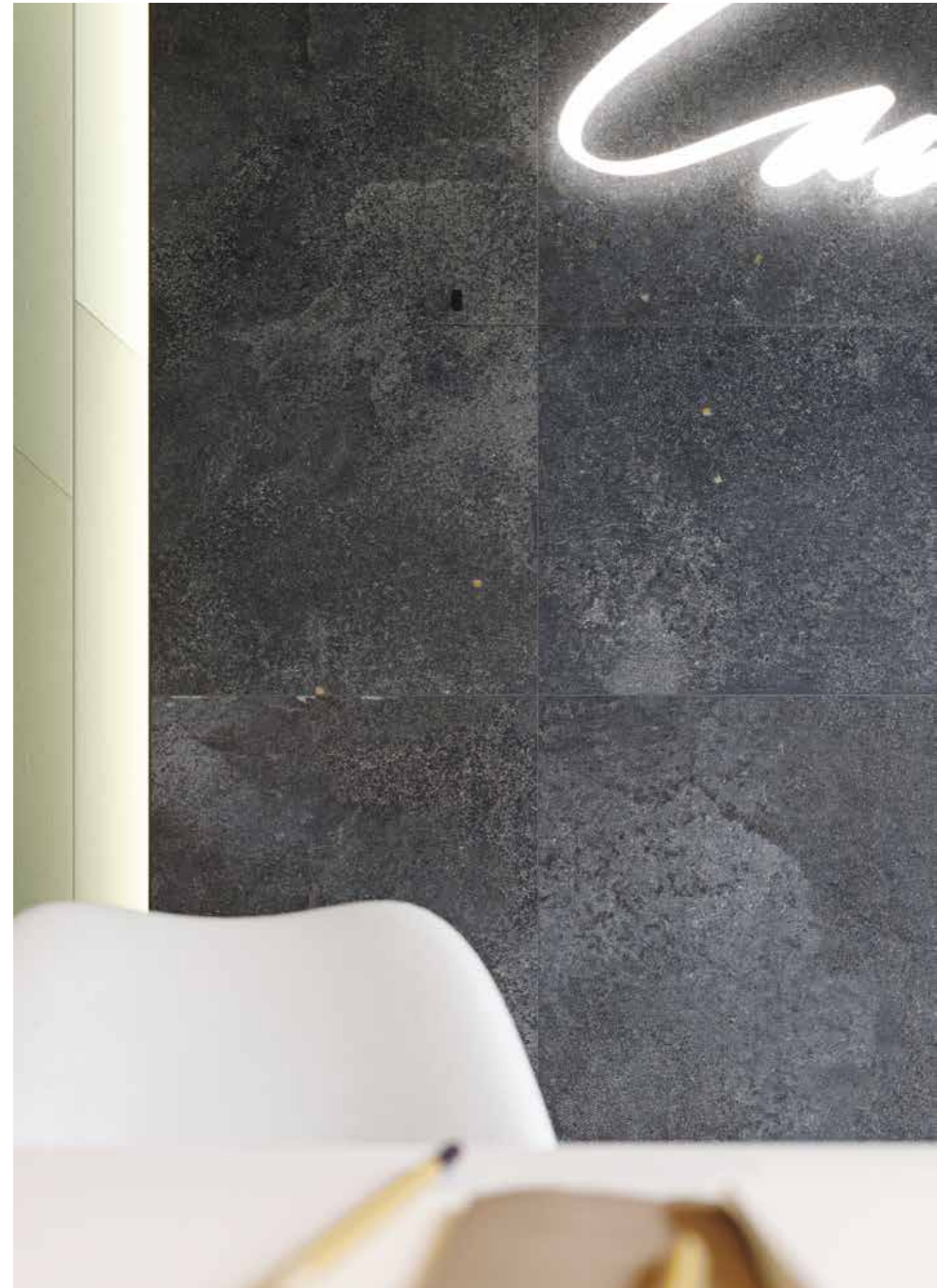



60x120

R10/B



DAKV9890
 PEI 5 ○ 700 | m²
 matt
 color **almond**
 beige | beige



DAKV9888
 PEI 4 ○ 700 | m²
 matt
 color **gravel**
 hellgrau | light grey



DAKV9889
 PEI 4 ○ 700 | m²
 matt
 color **slag**
 dunkelgrau | dark grey



60x60

10x10

5x5 | 30x30

R10/B



DAK62890
 PEI 5 ○ 560 | m²
 matt
 color **almond**
 beige | beige



DAK62888
 PEI 4 ○ 560 | m²
 matt
 color **gravel**
 hellgrau | light grey



DAK62889
 PEI 4 ○ 560 | m²
 matt
 color **slag**
 dunkelgrau | dark grey



DAK11890 (SHEET)
 PEI 5 ○ 900 | m²
 matt | >%



DDM05890 (SHEET)
 PEI 5 ○ 300 | Netz
 matt | >%



DAK11888 (SHEET)
 PEI 4 ○ 900 | m²
 matt | >%



DDM05888 (SHEET)
 PEI 4 ○ 300 | Netz
 matt | >%

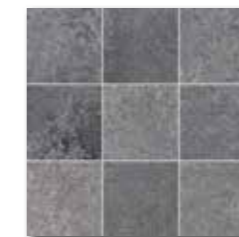

DAK11889 (SHEET)
 PEI 4 ○ 900 | m²
 matt | >%

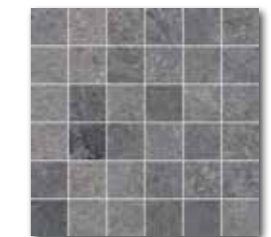

DDM05889 (SHEET)
 PEI 4 ○ 300 | Netz
 matt | >%

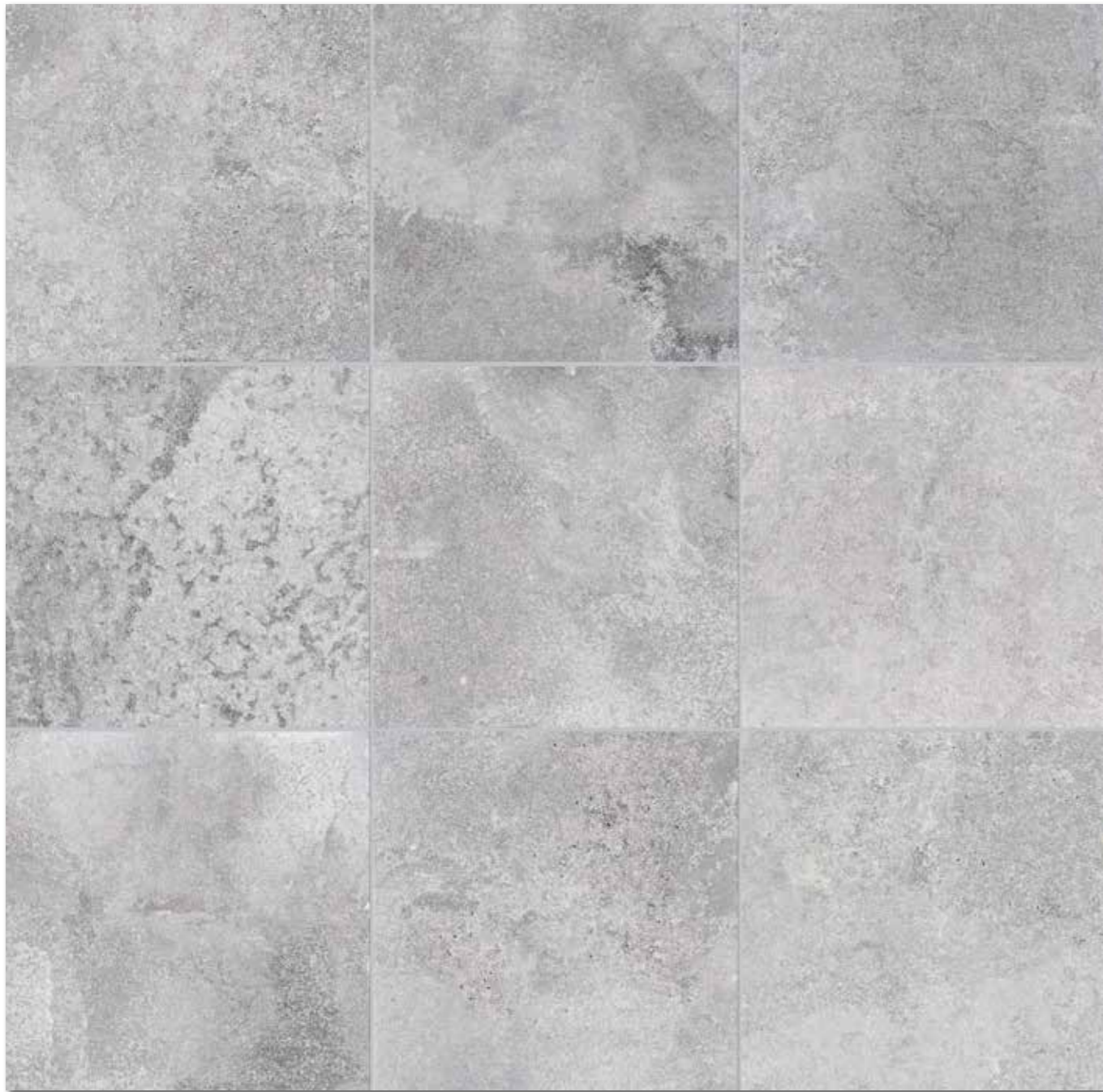

Die Fliesen der Serie zeichnen sich durch ein breites Farbspiel V4 aus. | All products of the entire batch show big deviations in shade difference V4.

Wir empfehlen, einzelne Fliesen aus mehreren Paketen herauszunehmen und den gesamten Bodenbelag nach der Inspirationsfotodokumentation in den Katalogen RAKO, eventuell den Webseiten www.rako.eu, zu komponieren. Wünschenswert ist die Kombination aller Fliesendesigns einschließlich ihrer Drehung um 90° oder 180°, sodass ausgewogene Optik der verlegten Fläche erzielt wird.

Before laying the tiles, we suggest you select from several cartons and arrange them as illustrated in the inspiration photo documentation in RAKO catalogues or website www.rako.eu, and mix the tiles to achieve the required result including turning them by 90° or 180°.

Produkt product	cm	mm	EN	St/m²	m²	kg	kg/m²	brutto kg			
Bodenfliese floor tile	60x120	598x1198x9	EN 14411 - G Bla	2	1,4	1,44	30	43,20	29,3	20,4	905
Bodenfliese floor tile	60x60	598x598x9	EN 14411 - G Bla	4	2,8	1,44	32	46,08	29,1	20,2	955
Bodenfliese floor tile	10x10	98x98x9	EN 14411 - G Bla	11	11	1,00	56	56,00	19,2	19,2	1125
Mosaik sheet 30x30 cm mosaic sheet 30x30 cm	5x5	48x48x9	EN 14411 - G Bla	3	11	0,27	-	-	5,2	-	-
Stufe step tile	30x120	298x1198x9	EN 14411 - G Bla	3	2,8	1,08	-	-	22,5	-	-
Stufe step tile	60x60	598x598x9	EN 14411 - G Bla	3	2,8	1,08	-	-	21,9	-	-
Socket skirting plinth	60x7,2	598x72x9	EN 14411 - G Bla	14	23,1	0,60	-	-	11,5	-	-
Stufenformteil special step tile	30x120	298x1198x9	STD No. 030 - 059824	2	-	-	-	-	-	-	-

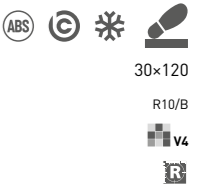

30x120
R10/B
V4
R

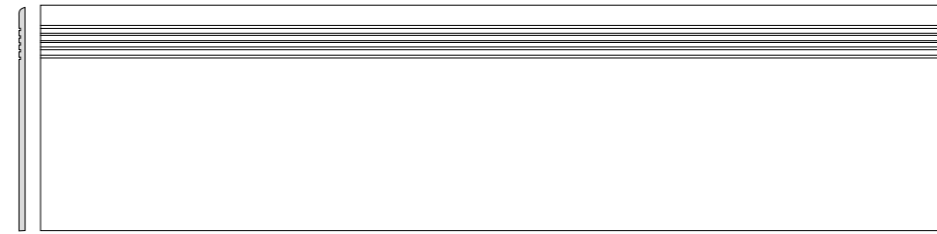

DCPVD888 color **gravel** | hellgrau | light grey
DCPVD889 color **slag** | dunkelgrau | dark grey
DCPVD890 color **almond** | beige | beige
PEI 4-5 ○ 740 | St
matt

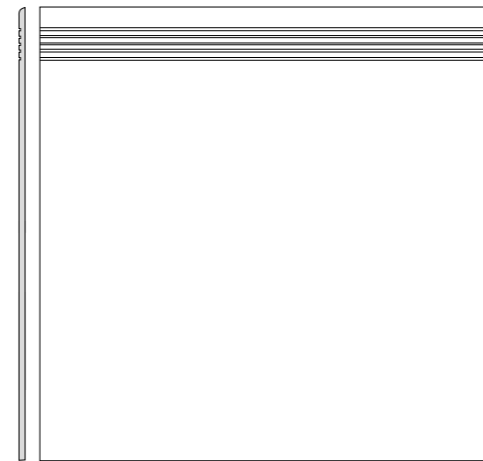

DCP62888 color **gravel** | hellgrau | light grey
DCP62889 color **slag** | dunkelgrau | dark grey
DCP62890 color **almond** | beige | beige
PEI 4-5 ○ 370 | St
matt



DSAS3888 color **gravel** | hellgrau | light grey
DSAS3889 color **slag** | dunkelgrau | dark grey
DSAS3890 color **almond** | beige | beige
○ 180 | St
matt

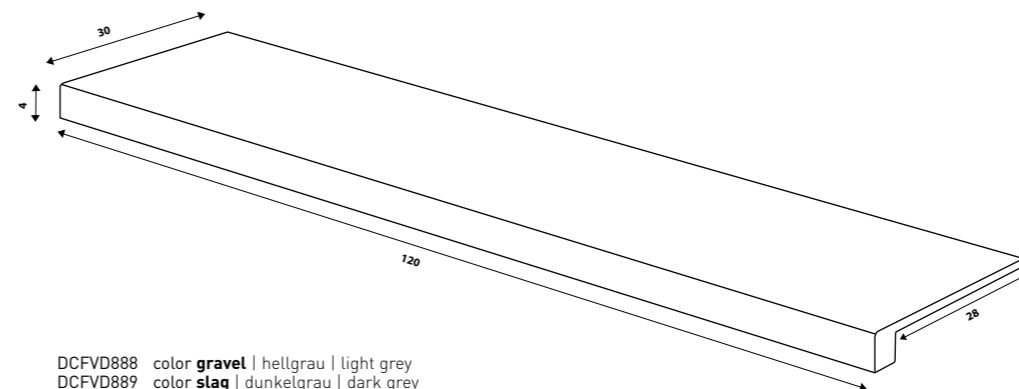

DCFVD888 color **gravel** | hellgrau | light grey
DCFVD889 color **slag** | dunkelgrau | dark grey
DCFVD890 color **almond** | beige | beige
PEI 4-5 ○ 1300 | St
matt

60x60
R10/B
V4
R

60x7,2
R

30x120
R10/B
V4
R

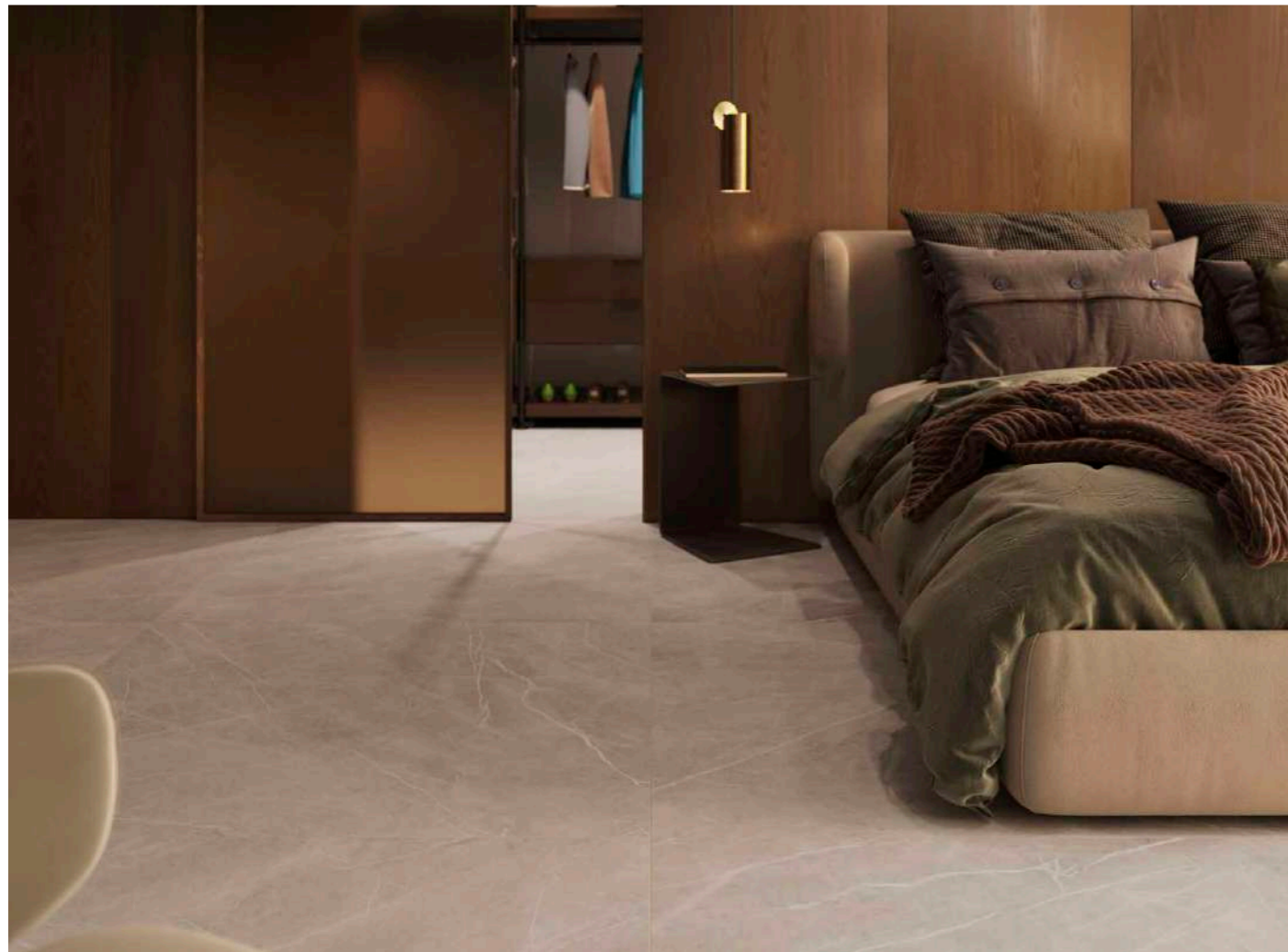



120x120

R9/A

v3



DAK92904
PEI 5 ○ 900 l m²
matt
color **silk**
hellbeige | light beige



DAK92905
PEI 4 ○ 900 l m²
matt
color **wheat**
beige | beige



120x120

R9/A

v3



DAK92902
PEI 5 ○ 900 l m²
matt
color **frost**
hellgrau | light grey



DAK92903
PEI 4 ○ 900 l m²
matt
color **dust**
grau | grey



60x120

R9/A

v3



DAKV9904
 PEI 5 ○ 700 l m²
 matt
 color **silk**
 hellbeige | light beige



DAKV9905
 PEI 4 ○ 700 l m²
 matt
 color **wheat**
 beige | beige



60x120

R9/A

v3



DAKV9902
 PEI 5 ○ 700 l m²
 matt
 color **frost**
 hellgrau | light grey



DAKV9903
 PEI 4 ○ 700 l m²
 matt
 color **dust**
 grau | grey

Produkt | product



120x120



60x120



EN 14411 - G Bla
 EN 14411 - G Bla



2



0,7



2,88



24



69,12



53,1



18,9



1 330

Bodenfliese | floor tile
 Bodenfliese | floor tile

60x120

598x1198-9

EN 14411 - G Bla
 EN 14411 - G Bla

2

1,4

1,44

30

43,20

29,3

20,4

905

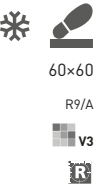

DAK62904
PEI 5 ○ 560 l m²
matt
color **silk**
hellbeige | light beige

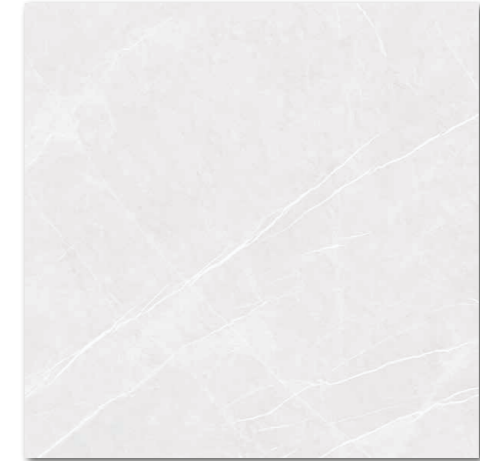

DAK62902
PEI 5 ○ 560 l m²
matt
color **frost**
hellgrau | light grey



DAK62905
PEI 4 ○ 560 l m²
matt
color **wheat**
beige | beige



DAK62903
PEI 4 ○ 560 l m²
matt
color **dust**
grau | grey



DDM05904 (SHEET)
PEI 5 ○ 300 | Netz
matt
color **silk**
hellbeige | light beige



DDM05905 (SHEET)
PEI 4 ○ 300 | Netz
matt
color **wheat**
beige | beige



DDM05902 (SHEET)
PEI 5 ○ 300 | Netz
matt
color **frost**
hellgrau | light grey



DDM05903 (SHEET)
PEI 4 ○ 300 | Netz
matt
color **dust**
grau | grey



Produkt | product



955

Bodenfliese | floor tile
Mosaik sheet 30x30 cm | mosaic sheet 30x30 cm

60x60
5x5

598-598-9
48-48-9

EN 14411 - G Bla
EN 14411 - G Bla

4

2,8

1,44

32

46,08

29,1

20,2



Die Fliesen der Serie zeichnen sich durch ein breites Farbspiel V3 aus. | All products of the entire batch show big deviations in shade difference V3.

Wir empfehlen, einzelne Fliesen aus mehreren Paketen herauszunehmen und den gesamten Bodenbelag nach der Inspirationsfotodokumentation in den Katalogen RAKO, eventuell den Webseiten www.rako.eu, zu komponieren. Wünschenswert ist die Kombination aller Fliesendesigns einschließlich ihrer Drehung um 90° oder 180°, sodass ausgewogene Optik der verlegten Fläche erzielt wird.

Before laying the tiles, we suggest you select from several cartons and arrange them as illustrated in the inspiration photo documentation in RAKO catalogues or website www.rako.eu, and mix the tiles to achieve the required result including turning them by 90° or 180°.

Produkt product	cm	mm	EN	St/m ²	St/m ²	St/m ²	St/m ²	St/m ²	kg/m ²	kg/m ²
Stufe I step tile	30x120	298x1198x9	EN 14411 - G Bla	3	2,8	1,08	-	-	22,5	-
Stufe I step tile	60x60	598x597x9	EN 14411 - G Bla	3	2,8	1,08	-	-	21,9	-
Socket I skirting plinth	60x7,2	598x72x9	EN 14411 - G Bla	14	23,1	0,60	-	-	11,5	-
Socket I skirting plinth	120x7,2	1198x72x9	EN 14411 - G Bla	11	11,9	0,93	-	-	20,4	-
Stufenformteil I special step tile	30x120	298x1198x9	STD No. 030 - 059824	2	-	-	-	-	-	-



30x120

R9/A

v3

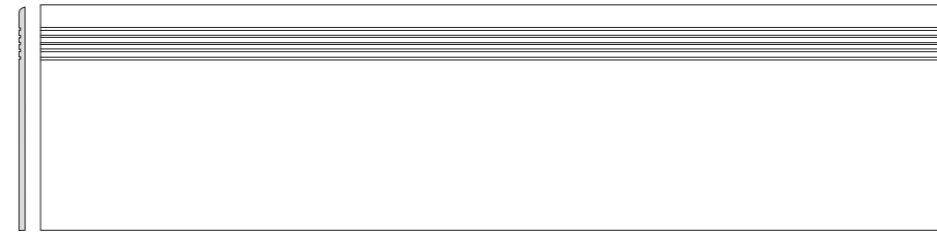

DCPVD902 color **frost** | hellgrau | light grey
 DCPVD903 color **dust** | grau | grey
 DCPVD904 color **silk** | hellbeige | light beige
 DCPVD905 color **wheat** | beige | beige
 PEI 4-5 ○ 740 | St
 matt

60x60

R9/A

v3



DCP62902 color **frost** | hellgrau | light grey
 DCP62903 color **dust** | grau | grey
 DCP62904 color **silk** | hellbeige | light beige
 DCP62905 color **wheat** | beige | beige
 PEI 4-5 ○ 370 | St
 matt



DSAS3902 color **frost** | hellgrau | light grey
 DSAS3903 color **dust** | grau | grey
 DSAS3904 color **silk** | hellbeige | light beige
 DSAS3905 color **wheat** | beige | beige
 ○ 180 | St
 matt

60x7,2



DSA99902 color **frost** | hellgrau | light grey
 DSA99903 color **dust** | grau | grey
 DSA99904 color **silk** | hellbeige | light beige
 DSA99905 color **wheat** | beige | beige
 ○ 380 | St
 matt

120x7,2

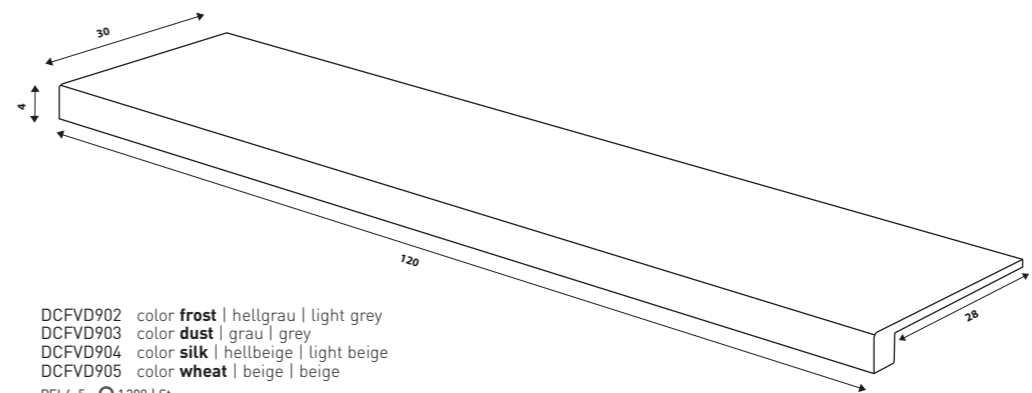

DCFVD902 color **frost** | hellgrau | light grey
 DCFVD903 color **dust** | grau | grey
 DCFVD904 color **silk** | hellbeige | light beige
 DCFVD905 color **wheat** | beige | beige
 PEI 4-5 ○ 1300 | St
 matt

30x120

R9/A

v3



News

Home

RAKO



WIRVN529
 O 1 150 l set
 relief matt | structure matt

(SHEET)



News

RAKO Home

Produkt | product



brutto kg

Dekor 1 set/8 St | decor 1 set/8 pcs

30x90

298x898x8

EN 14411 - L Bill

4x4

3,7

2,16

-

-

2x15,9

14,8

-





60x120
v3
R



DARV1730
PEI 5 \odot 700 l m²
relief matt | R10/A
elfenbein | ivory

DAPV1730
PEI 5 \odot 870 l m²
relief lappato | R9



DARV1732
PEI 5 \odot 700 l m²
relief matt | R10/A
braun-grau | brown-grey

DAPV1732
PEI 5 \odot 870 l m²
relief lappato | R9

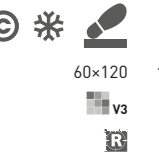

60x120
v3
R



DARV1731
PEI 5 \odot 700 l m²
relief matt | R10/A
beige | beige

DAPV1731
PEI 5 \odot 870 l m²
relief lappato | R9



DARV1733
PEI 4 \odot 700 l m²
relief matt | R10/A
grau | grey

DAPV1733
PEI 4 \odot 870 l m²
relief lappato | R9





Die Fliesen der Serie zeichnen sich durch ein breites Farbspiel V3 aus. | All products of the entire batch show big deviations in shade difference V3.

Wir empfehlen, einzelne Fliesen aus mehreren Paketen herauszunehmen und den gesamten Bodenbelag nach der Inspirationsfotodokumentation in den Katalogen RAKO, eventuell den Webseiten www.rako.eu, zu komponieren. Wünschenswert ist die Kombination aller Fliesendesigns einschließlich ihrer Drehung um 90° oder 180°, sodass ausgewogene Optik der verlegten Fläche erzielt wird.

Before laying the tiles, we suggest you select from several cartons and arrange them as illustrated in the inspiration photo documentation in RAKO catalogues or website www.rako.eu, and mix the tiles to achieve the required result including turning them by 90° or 180°.



DAR63730
PEI 5 \odot 560 | m²
relief matt | R10/A

DAP63730
PEI 5 \odot 610 | m²
relief lappato | R9



DAR63731
PEI 5 \odot 560 | m²
relief matt | R10/A

DAP63731
PEI 5 \odot 610 | m²
relief lappato | R9

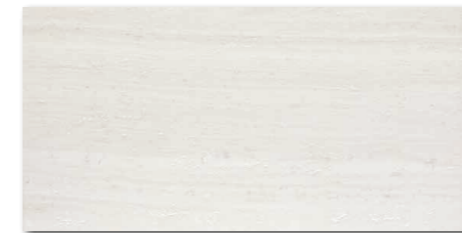

DARSE730
PEI 5 \odot 540 | m²
relief matt | R10/A
elfenbein | ivory

DAPSE730
PEI 5 \odot 600 | m²
relief lappato | R9



DARSE731
PEI 5 \odot 540 | m²
relief matt | R10/A
beige | beige

DAPSE731
PEI 5 \odot 600 | m²
relief lappato | R9



DAR63732
PEI 5 \odot 560 | m²
relief matt | R10/A

DAP63732
PEI 5 \odot 610 | m²
relief lappato | R9



DAR63733
PEI 4 \odot 560 | m²
relief matt | R10/A

DAP63733
PEI 4 \odot 610 | m²
relief lappato | R9



DARSE732
PEI 5 \odot 540 | m²
relief matt | R10/A
braun-grau | brown-grey

DAPSE732
PEI 5 \odot 600 | m²
relief lappato | R9



DARSE733
PEI 4 \odot 540 | m²
relief matt | R10/A
grau | grey

DAPSE733
PEI 4 \odot 600 | m²
relief lappato | R9



60x60
v3
R

30x60
v3
R

60x60
v3
R

30x60
v3
R

Produkt | product



Bodenfliese floor tile	60x60	598-598x10	EN 14411 - G Bla	3	2,8	1,08	32	34,56	23,7	21,9	782
Bodenfliese floor tile	30x60	298-598x10	EN 14411 - G Bla	6	5,6	1,08	40	43,20	23,7	21,9	971

Empfohlene Formatkombinationen siehe Seite 522-523. | Recommended combinations of modular sizes see pages 522-523.



30x60

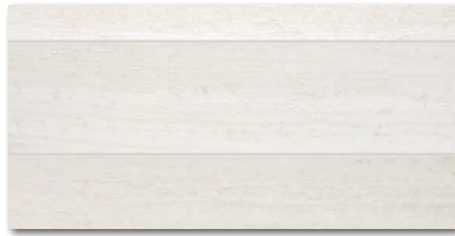
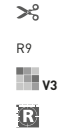

DDPSE730 (SHEET)
PEI 5 500 | Netz
relief matt/lappato
elfenbein | ivory



DDPSE731 (SHEET)
PEI 5 500 | Netz
relief matt/lappato
beige | beige



DDPSE732 (SHEET)
PEI 5 500 | Netz
relief matt/lappato
braun-grau | brown-grey



DDPSE733 (SHEET)
PEI 4 500 | Netz
relief matt/lappato
grau | grey

5x5 | 30x30

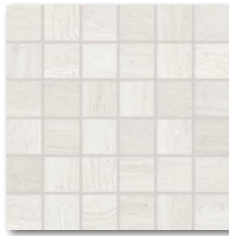

DDM06730 (SHEET)
PEI 5 300 | Netz
relief matt/lappato
elfenbein | ivory



DDM06731 (SHEET)
PEI 5 300 | Netz
relief matt/lappato
beige | beige



DDM06732 (SHEET)
PEI 5 300 | Netz
relief matt/lappato
braun-grau | brown-grey



DDM06733 (SHEET)
PEI 4 300 | Netz
relief matt/lappato
grau | grey



30x120

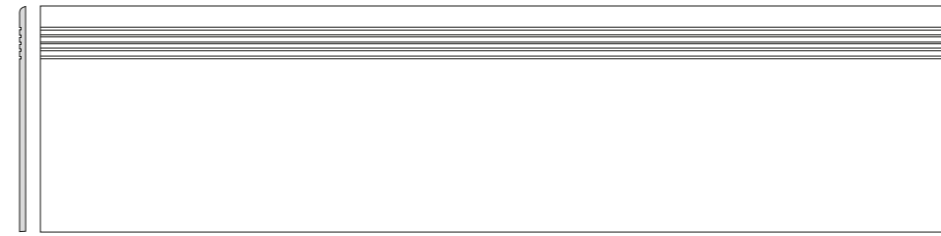

DCPVF730 elfenbein | ivory
DCPVF731 beige | beige
DCPVF732 braun-grau | brown-grey
DCPVF733 grau | grey
PEI 4-5 740 | St
relief matt

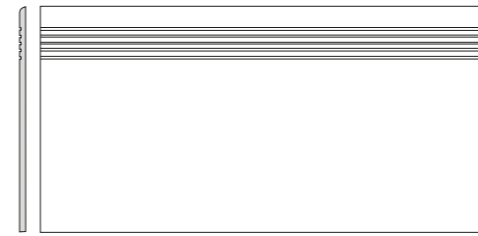

DCPSE730 elfenbein | ivory
DCPSE731 beige | beige
DCPSE732 braun-grau | brown-grey
DCPSE733 grau | grey
PEI 4-5 270 | St
relief matt



DSAS4730 elfenbein | ivory
DSAS4731 beige | beige
DSAS4732 braun-grau | brown-grey
DSAS4733 grau | grey
 180 | St
relief matt

DSKS4730
DSKS4731
DSKS4732
DSKS4733
 270 | St
relief lappato

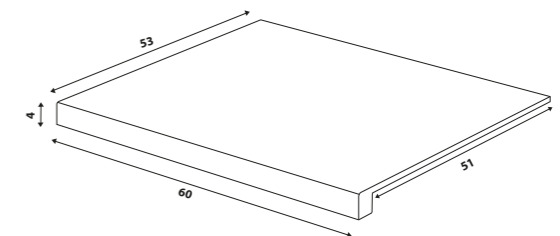

DCF65730 elfenbein | ivory
DCF65731 beige | beige
DCF65732 braun-grau | brown-grey
DCF65733 grau | grey
PEI 4-5 900 | St
relief matt | R10/A

DCG65730
DCG65731
DCG65732
DCG65733
PEI 4-5 900 | St
relief lappato | R9

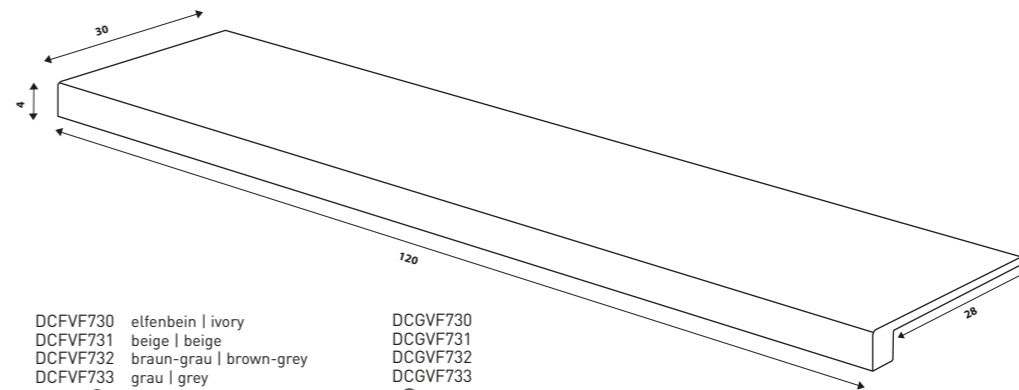

DCFVF730 elfenbein | ivory
DCFVF731 beige | beige
DCFVF732 braun-grau | brown-grey
DCFVF733 grau | grey
PEI 4-5 1300 | St
relief matt | R10/A

DCGVF730
DCGVF731
DCGVF732
DCGVF733
PEI 4-5 1450 | St
relief lappato | R9

Produkt product	cm	mm	EN	St/m ²	m ²	kg	kg/m ²	breitensieg
Dekor (set) decor (set)	30x60	298x598x10	EN 14411 - G Bla	4	5,6	0,72	-	15,8
Mosaik set 30x30 cm mosaic sheet 30x30 cm	5x5	48x48x10	EN 14411 - G Bla	3	11	0,27	-	5,9
Stufe step tile	30x120	298x1198x10	EN 14411 - G Bla	3/5	2,8	1,08/1,8	-	24,6/40,9
Stufe step tile	30x60	298x598x10	EN 14411 - G Bla	6	5,6	1,08	-	23,7
Sockel skirting plinth	60x9,5	598x95x10	EN 14411 - G Bla	13	17,5	0,74	-	16,2
Stufenformteil special step tile	60x53	598x530x10	STO No. 030 - 059824	2	-	-	-	-
Stufenformteil special step tile	30x120	298x1198x10	STO No. 030 - 059824	2	-	-	-	-

60x53

30x120



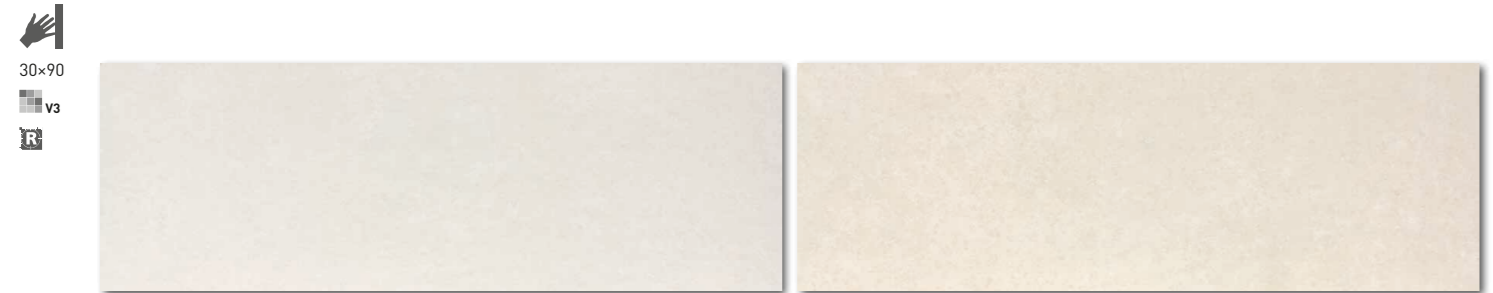

WARV5430*
WARVN430**
○ 750 l m²
relief matt

WARV5431*
WARVN431**
○ 750 l m²
relief matt



WR1V5430*
WR1VN430**
○ 750 l m²
relief matt
elfenbein | ivory

WR1V5431*
WR1VN431**
○ 750 l m²
relief matt
hellbeige | light beige



WR1V5435*
WR1VN435**
○ 750 l m²
relief matt
hellbeige | light beige

WR1V5434*
WR1VN434**
○ 750 l m²
relief matt
braun | brown



WDM05430 (SHEET)
○ 250 l Netz
relief matt
elfenbein | ivory



WDM05431 (SHEET)
○ 250 l Netz
relief matt
hellbeige | light beige

* Verfügbar solange der Vorrat reicht | Available while stocks last
** Neues Produkt in 8 mm Stärke im Laufe des Jahres 2025 verfügbar | New product in 8 mm thickness available during 2025

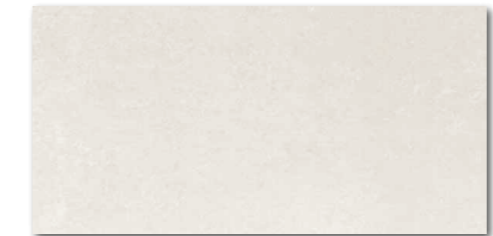

WARVK430
○ 500 l m²
relief matt

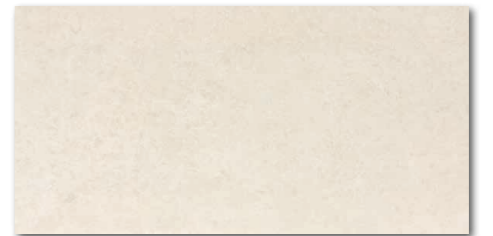

WARVK431
○ 500 l m²
relief matt



WR1VK430
○ 500 l m²
relief matt
elfenbein | ivory



WR1VK431
○ 500 l m²
relief matt
hellbeige | light beige



WR1VK435
○ 500 l m²
relief matt
hellbeige | light beige



WR1VK434
○ 500 l m²
relief matt
braun | brown



WLRSP430
○ 600 l St
relief matt



WLRSP431
○ 600 l St
relief matt

Produkt product	cm	mm	EN	Stk	St/m ²	mm	kg	kg	kg	kg	kg	kg
Wandfliese wall tile*	30x90	298x898x10	EN 14411 - L BIII	4	3,7	1,08	30	32,40	20,0	18,5	625	
Wandfliese wall tile**	30x90	298x898x8	EN 14411 - L BIII	5	3,7	1,35	30	40,50	20,0	14,8	625	
Wandfliese wall tile	30x60	298x598x8	EN 14411 - L BIII	8	5,56	1,44	40	57,60	21,3	14,8	876	
Bordüre relief listel	60x7	598x70x20	STO No. 030 - 060753	4	23,8	0,17	-	-	3,4	-	-	-
Mosaik set 30x30 cm mosaic sheet 30x30 cm	5x5	48x48x8	STO No. 030 - 059826	4	11	0,36	-	-	5,2	-	-	-

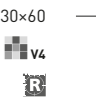



60x60
R9/A
V3
R

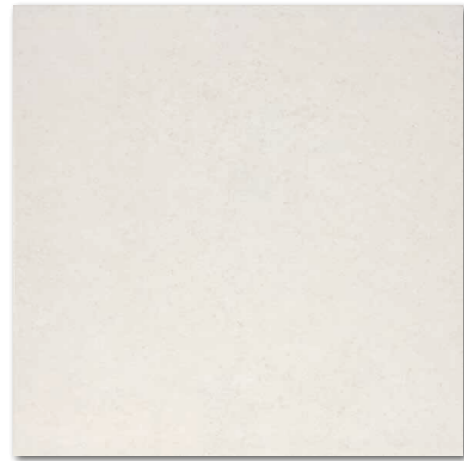

DAK63430*
DAK62430**
PEI 5 ○ 560 l m²
relief matt



DAK63431*
DAK62431**
PEI 5 ○ 560 l m²
relief matt



DAK63432*
DAK62432**
PEI 5 ○ 560 l m²
relief matt



DAK63433*
DAK62433**
PEI 4 ○ 560 l m²
relief matt



60x60
R9/A
V3
R

5x5 | 30x30

R10/A
V3
R



DDN06430* (SHEET)
DDM05430**
PEI 5 ○ 300 l Netz
relief matt
elfenbein | ivory



DDN06431* (SHEET)
DDM05431**
PEI 5 ○ 300 l Netz
relief matt
hellbeige | light beige



DDN06432* (SHEET)
DDM05432**
PEI 5 ○ 300 l Netz
relief matt
hellgrau | light grey

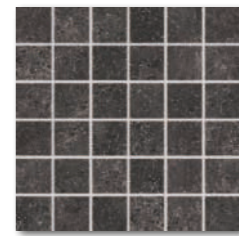

DDN06433* (SHEET)
DDM05433**
PEI 4 ○ 300 l Netz
relief matt
schwarz | black

5x5 | 30x30

R10/A
V3
R

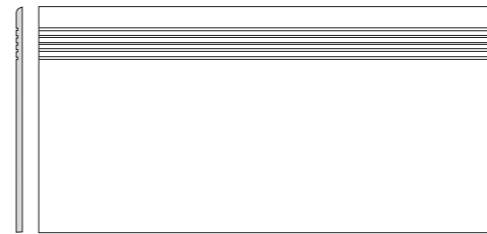

DCPSE430* | **DCPSR430**** elfenbein | ivory
DCPSE431* | **DCPSR431**** hellbeige | light beige
DCPSE432* | **DCPSR432**** hellgrau | light grey
DCPSE433* | **DCPSR433**** schwarz | black
PEI 4-5 ○ 270 l St
relief matt | R9/A | V3



DSAS4430* | **DSAS3430**** elfenbein | ivory
DSAS4431* | **DSAS3431**** hellbeige | light beige
DSAS4432* | **DSAS3432**** hellgrau | light grey
DSAS4433* | **DSAS3433**** schwarz | black
○ 180 l St
relief matt

30x60
60x9,5
R

Produkt product	cm	mm	EN	St/m ²	kg/m ²	kg/m ²	kg/m ²	kg/m ²	kg/m ²	kg/m ²	kg/m ²
Bodenfliese floor tile*	60x60	598x598x10	EN 14411 - G Bla	3	2,8	1,08	32	34,56	23,7	21,9	782
Bodenfliese floor tile**	60x60	598x598x9	EN 14411 - G Bla	4	2,8	1,44	32	46,08	29,1	20,2	955
Mosaik set 30x30 cm mosaic sheet 30x30 cm*	5x5	48x48x10	EN 14411 - G Bla	3	11	0,27	-	-	5,9	-	-
Mosaik 30x30 cm mosaic sheet 30x30 cm**	5x5	48x48x9	EN 14411 - G Bla	3	11	0,27	-	-	5,2	-	-
Stufe step tile*	30x60	298x598x10	EN 14411 - G Bla	6	5,6	1,08	-	-	23,7	-	-
Stufe step tile**	30x60	298x598x9	EN 14411 - G Bla	5	5,6	0,90	-	-	17,3	-	-
Sockel skirting plinth*	60x9,5	598x95x10	EN 14411 - G Bla	13	17,5	0,74	-	-	16,2	-	-
Sockel skirting plinth**	60x7,2	598x72x9	EN 14411 - G Bla	14	23,1	0,60	-	-	11,5	-	-

* Verfügbar solange der Vorrat reicht | Available while stocks last

**** Neues Produkt in 9 mm Stärke im Laufe des Jahres 2025 verfügbar | New product in 9 mm thickness available during 2025**

Die Fliesen der Serie zeichnen sich durch ein breites Farbspiel V3 aus. | All products of the entire batch show big deviations in shade difference V3.

Empfohlene Formatkombinationen siehe Seite 522-523. | Recommended combinations of modular sizes see pages 522-523.



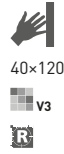

WAKV6790
 ○ 680 l m²
 matt
 weiß-grau | white-grey



WAKV6791
 ○ 680 l m²
 matt
 grau | grey



WAKV6792
 ○ 680 l m²
 matt
 schwarz | black



WAKV6793
 ○ 680 l m²
 matt
 hellbeige | light beige



WAKV6794
 ○ 680 l m²
 matt
 dunkelbeige | dark beige





30×60

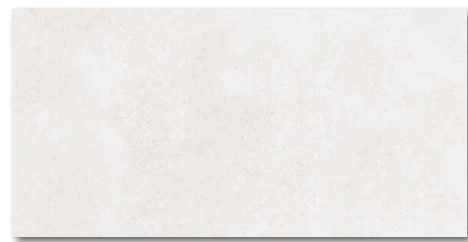

WADV790
○ 480 l m²
matt | **V3**
weiß-grau | white-grey

WAKVK790
○ 500 l m²
matt | **V3** | **DF**

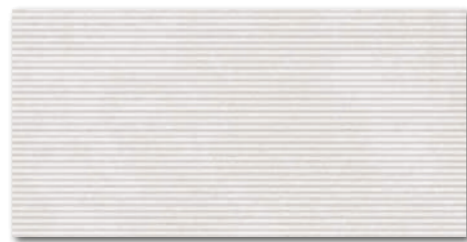

WARVK790
○ 480 l m²
relief matt | **V3**
weiß-grau | white-grey



WADV793
○ 480 l m²
matt | **V3**
hellbeige | light beige

WAKVK793
○ 500 l m²
matt | **V3** | **DF**

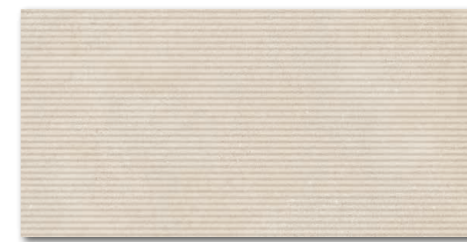

WARVK793
○ 480 l m²
relief matt | **V3**
hellbeige | light beige



30×60



WADV791
○ 480 l m²
matt | **V3**
grau | grey

WAKVK791
○ 500 l m²
matt | **V3** | **DF**



WARVK791
○ 480 l m²
relief matt | **V3**
grau | grey



WADV794
○ 480 l m²
matt | **V3**
dunkelbeige | dark beige

WAKVK794
○ 500 l m²
matt | **V3** | **DF**



WAKVK797
○ 500 l m²
matt | **V4** | **DF**
mehrfarbig | multicoloured



WADV792
○ 480 l m²
matt | **V3**
schwarz | black

WAKVK792
○ 500 l m²
matt | **V3** | **DF**

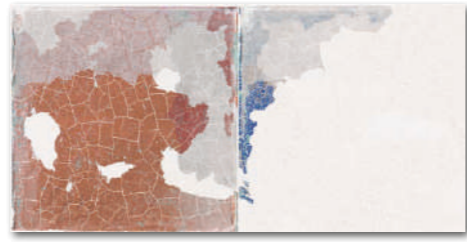

WAKVK796
○ 500 l m²
matt | **V4** | **DF**
mehrfarbig | multicoloured

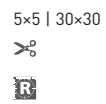

5×5 | 30×30



WDM05790 (SHEET)
○ 250 l Netz
matt | **V3**
weiß-grau | white-grey

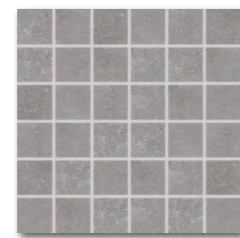

WDM05791 (SHEET)
○ 250 l Netz
matt | **V3**
grau | grey

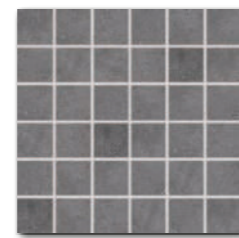

WDM05792 (SHEET)
○ 250 l Netz
matt | **V3**
schwarz | black

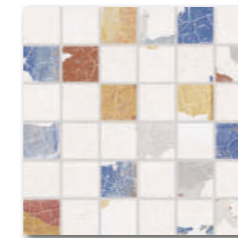

WDM05796 (SHEET)
○ 250 l Netz
matt | **V4** | **DF**
mehrfarbig | multicoloured



WDM05793 (SHEET)
○ 250 l Netz
matt | **V3**
hellbeige | light beige



WDM05794 (SHEET)
○ 250 l Netz
matt | **V3**
dunkelbeige | dark beige



WDM05797 (SHEET)
○ 250 l Netz
matt | **V4** | **DF**
mehrfarbig | multicoloured



5×5 | 30×30

Produkt | product



Produkt product	cm	mm	EN	Stk/m ²	kg/m ²	mm	m ²	kg	kg/m ²	kg/m ²
Wandfliese wall tile	30×60	298×598×8	EN 14411 - L BIII	8	5,56	1,44	40	57,60	21,3	14,8
Mosaik set 30×30 cm mosaic sheet 30×30 cm	5×5	48×48×8	STO No. 030 - 059826	4	11	0,36	-	-	5,2	14,8

Die Produktverpackung enthält zufällige Designmöglichkeiten. | The products are deliberately mixed in packing to include a random selection of designs.



120x120

R10/B

v3

R



DAK92790
PEI 5 ○ 900 l m²
matt
weiß-grau | white-grey



120x120

R10/B

v3

R



DAK92791
PEI 4 ○ 900 l m²
matt
grau | grey



DAK92792
PEI 4 ○ 900 l m²
matt
schwarz | black

Produkt | product



120x120



1198-1198-8,5



EN 14411 - G Bla



2



0,7



2,88



24



69,12



53,1



18,9



1 330

Bodenfliese | floor tile

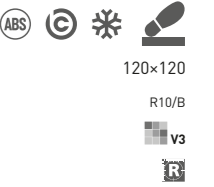

120x120

R10/B

v3

R



DAK92793
PEI 5 ○ 900 | m²
matt
hellbeige | light beige



DAK92794
PEI 4 ○ 900 | m²
matt
dunkelbeige | dark beige



60x120
R10/B
v3
R



DAKV1790*
DAKV9790**
PEI 5 ○ 700 l m²
matt
weiß-grau | white-grey



DAKV1791*
DAKV9791**
PEI 4 ○ 700 l m²
matt
grau | grey



DAKV1792*
DAKV9792**
PEI 4 ○ 700 l m²
matt
schwarz | black

Produkt | product



Bodenfliese floor tile*	60x120	598x1198x10	EN 14411 - G Bla	2	1,4	1,44	27	38,88	32,7	22,7	908
Bodenfliese floor tile**	60x120	598x1198x9	EN 14411 - G Bla	2	1,4	1,44	30	43,20	29,3	20,4	905



60x120
R10/B
v3
R



DAKV1793*
DAKV9793**
PEI 5 ○ 700 l m²
matt
hellbeige | light beige



DAKV1794*
DAKV9794**
PEI 4 ○ 700 l m²
matt
dunkelbeige | dark beige

* Verfügbar solange der Vorrat reicht | Available while stocks last

** Neues Produkt in 9 mm Stärke im Laufe des Jahres 2025 verfügbar | New product in 9 mm thickness available during 2025

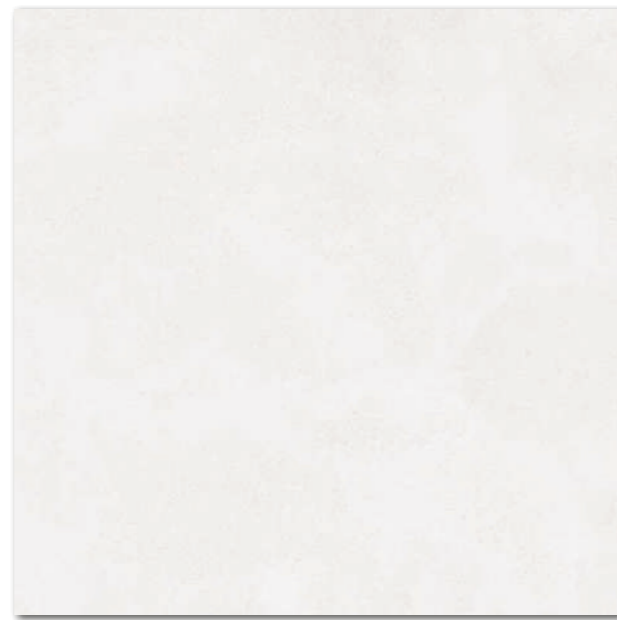
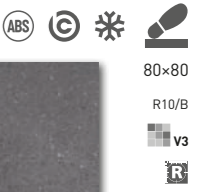
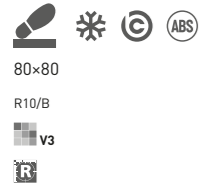

DAK81790
PEI 5 ○ 700 l m²
matt
weiß-grau | white-grey



DAK81791
PEI 4 ○ 700 l m²
matt
grau | grey



DAK81792
PEI 4 ○ 700 l m²
matt
schwarz | black



DAK81793
PEI 5 ○ 700 l m²
matt
hellbeige | light beige



DAK81794
PEI 4 ○ 700 l m²
matt
dunkelbeige | dark beige

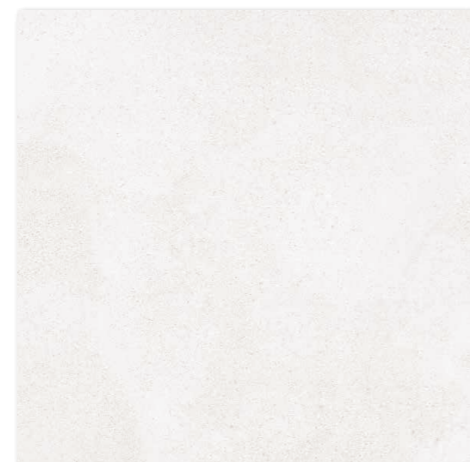

DAK63790*
DAK62790**
PEI 5 ○ 560 l m²
matt | R10/B

DAF63790*
DAF62790**
PEI 5 ○ 640 l m²
matt | R11/B

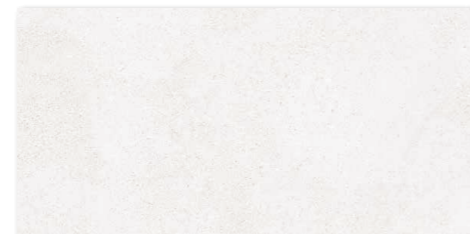

DAKSE790*
DAKSR790**
PEI 5 ○ 540 l m²
matt | R10/B

DAFSE790*
DAFSR790**
PEI 5 ○ 620 l m²
matt | R11/B

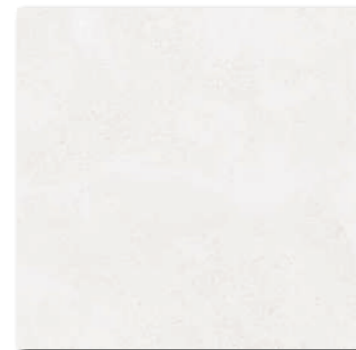

DAA4H790
PEI 5 ○ 510 l m²
matt



DDVP4790
PEI 5 ○ 500 l Netz
matt

weiß-grau | white-grey

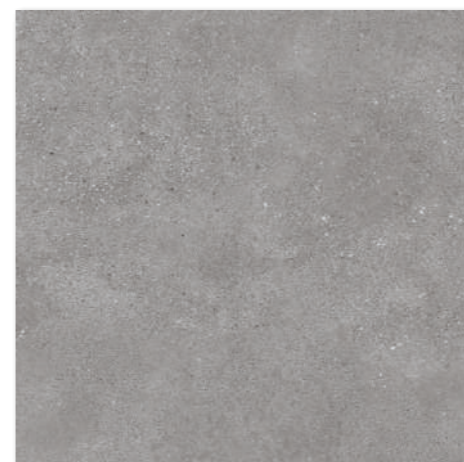

DAK63791*
DAK62791**
PEI 4 ○ 560 l m²
matt | R10/B

DAF63791*
DAF62791**
PEI 4 ○ 640 l m²
matt | R11/B



DAKSE791*
DAKSR791**
PEI 4 ○ 540 l m²
matt | R10/B

DAFSE791*
DAFSR791**
PEI 4 ○ 620 l m²
matt | R11/B



DAA4H791
PEI 4 ○ 510 l m²
matt



DDVP4791
PEI 4 ○ 500 l Netz
matt

grau | grey



DAK63792*
DAK62792**
PEI 4 ○ 560 l m²
matt | R10/B

DAF63792*
DAF62792**
PEI 4 ○ 640 l m²
matt | R11/B



DAKSE792*
DAKSR792**
PEI 4 ○ 540 l m²
matt | R10/B

DAFSE792*
DAFSR792**
PEI 4 ○ 620 l m²
matt | R11/B



DAA4H792
PEI 4 ○ 510 l m²
matt



DDVP4792
PEI 4 ○ 500 l Netz
matt

schwarz | black

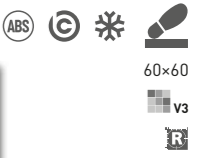

60x60
v3
R

30x60
v3
R

45x45
R10/B
v3

30x45
R10/B
v3
R

RAKO Home

Produkt product	cm	mm	EN	Stk/m ²	Stk/m ²	Stk/m ²	Stk/m ²	Stk/m ²	Stk/m ²	Stk/m ²	Stk/m ²	kg/m ²	kg/m ²
Bodenfliese floor tile*	60x60	598x598x10	EN 14411 - G Bla	3	2,8	1,08	32	34,56	23,7	21,9	782		
Bodenfliese floor tile**	60x60	598x598x9	EN 14411 - G Bla	4	2,8	1,44	32	46,08	29,1	20,2	955		
Bodenfliese floor tile*	30x60	298x598x10	EN 14411 - G Bla	6	5,6	1,08	40	43,20	23,7	21,9	971		
Bodenfliese floor tile**	30x60	298x598x9	EN 14411 - G Bla	7	5,6	1,26	40	50,40	24,2	19,2	993		
Bodenfliese floor tile	45x45	448x448x8	EN 14411 - G Bla	6	5	1,21	34	41,14	21,1	17,4	741		
Dekor (set) decor (sheet)	30x45	298x445x8	EN 14411 - G Bla	5	7,4	0,68	36	-	11,5	17,4	-		

* Verfügbar solange der Vorrat reicht | Available while stocks last

**** Neues Produkt in 9 mm Stärke im Laufe des Jahres 2025 verfügbar | New product in 9 mm thickness available during 2025**

Empfohlene Formatkombinationen siehe Seite 522-523. | Recommended combinations of modular sizes see pages 522-523.



Die Fliesen der Serie zeichnen sich durch ein breites Farbspiel V3 | V4 aus. | All products of the entire batch show big deviations in shade difference V3 | V4.

Wir empfehlen, einzelne Fliesen aus mehreren Paketen herauszunehmen und den gesamten Bodenbelag nach der Inspirationsfotodokumentation in den Katalogen RAKO, eventuell den Webseiten www.rako.eu, zu komponieren. Wünschenswert ist die Kombination aller Fliesendesigns einschließlich ihrer Drehung um 90° oder 180°, sodass ausgewogene Optik der verlegten Fläche erzielt wird.

Before laying the tiles, we suggest you select from several cartons and arrange them as illustrated in the inspiration photo documentation in RAKO catalogues or website www.rako.eu, and mix the tiles to achieve the required result including turning them by 90° or 180°.



DAK63793*
DAK62793**
PEI 5 ○ 560 | m²
matt | R10/B

DAF63793*
DAF62793**
PEI 5 ○ 640 | m²
matt | R11/B



DAK63794*
DAK62794**
PEI 4 ○ 560 | m²
matt | R10/B

DAF63794*
DAF62794**
PEI 4 ○ 640 | m²
matt | R11/B



DAKSE793*
DAKSR793**
PEI 5 ○ 540 | m²
matt | R10/B

DAFSE793*
DAFSR793**
PEI 5 ○ 620 | m²
matt | R11/B



DAKSE794*
DAKSR794**
PEI 4 ○ 540 | m²
matt | R10/B

DAFSE794*
DAFSR794**
PEI 4 ○ 620 | m²
matt | R11/B



DAA4H793
PEI 5 ○ 510 | m²
matt



DAA4H794
PEI 4 ○ 510 | m²
matt



DDVP4793
PEI 5 ○ 500 | Netz
matt
hellbeige | light beige

(SHEET)



DDVP4794
PEI 4 ○ 500 | Netz
matt
dunkelbeige | dark beige

(SHEET)

* Verfügbar solange der Vorrat reicht | Available while stocks last

** Neues Produkt in 9 mm Stärke im Laufe des Jahres 2025 verfügbar | New product in 9 mm thickness available during 2025

Empfohlene Formatkombinationen siehe Seite 522-523. | Recommended combinations of modular sizes see pages 522-523.

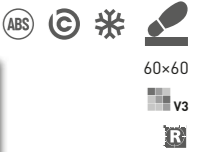

60x60
v3
R

30x60
v3
R

45x45
R10/B
v3

30x45
R10/B
v3
R

Produkt product	cm	mm	EN	Stk/m ²	Stk/m ²	Stk/m ²	Stk/m ²	Stk/m ²	Stk/m ²	Stk/m ²	Stk/m ²
Bodenfliese floor tile*	60x60	598x598x10	EN 14411 - G Bla	3	2,8	1,08	32	34,56	23,7	21,9	782
Bodenfliese floor tile**	60x60	598x598x9	EN 14411 - G Bla	4	2,8	1,44	32	46,08	29,1	20,2	955
Bodenfliese floor tile*	30x60	298x598x10	EN 14411 - G Bla	6	5,6	1,08	40	43,20	23,7	21,9	971
Bodenfliese floor tile**	30x60	298x598x9	EN 14411 - G Bla	7	5,6	1,26	40	50,40	24,2	19,2	993
Bodenfliese floor tile	45x45	448x448x8	EN 14411 - G Bla	6	5	1,21	34	41,14	21,1	17,4	741
Dekor (set) decor (sheet)	30x45	298x445x8	EN 14411 - G Bla	5	7,4	0,68	36	-	11,5	17,4	-



DAK63795*
DAK62795**
 PEI 5 \bigcirc 560 | m²
 matt | **V4**

weiß-grau | white-grey



DAK63796*
DAK62796**
 PEI 4 \bigcirc 560 | m²
 matt | **V4**

grau | grey



DAK63797*
DAK62797**
 PEI 5 \bigcirc 560 | m²
 matt | **V4**

beige | beige



DAKV1795*
DAKV9795**
 PEI 5 \bigcirc 700 | m²
 matt | **V3**

weiß-grau | white-grey

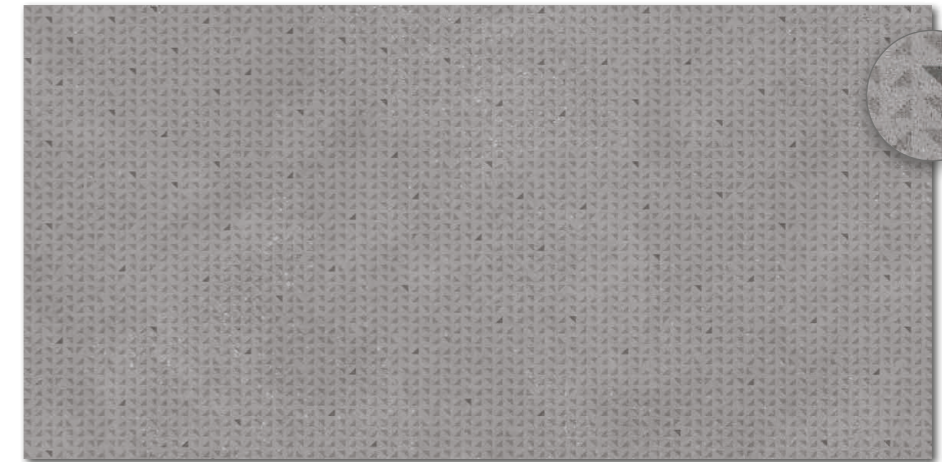

DAKV1796*
DAKV9796**
 PEI 4 \bigcirc 700 | m²
 matt | **V3**

grau | grey



DAKV1797*
DAKV9797**
 PEI 5 \bigcirc 700 | m²
 matt | **V3**

beige | beige

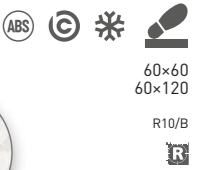

60x60
 60x120
 R10/B

Produkt | product



Produkt product	cm	mm	EN	mm	kg/m ²	kg	kg	kg	kg	kg	kg
Bodenfliese floor tile*	60x60	598x598x10	EN 14411 - G Bla	3	2,8	1,08	32	34,56	23,7	21,9	782
Bodenfliese floor tile**	60x60	598x598x9	EN 14411 - G Bla	4	2,8	1,44	32	46,08	29,1	20,2	955
Bodenfliese floor tile*	60x120	598x1198x10	EN 14411 - G Bla	2	1,4	1,44	27	38,88	32,7	22,7	908
Bodenfliese floor tile**	60x120	598x1198x9	EN 14411 - G Bla	2	1,4	1,44	30	43,20	29,3	20,4	905

* Verfügbar solange der Vorrat reicht | Available while stocks last

** Neues Produkt in 9 mm Stärke im Laufe des Jahres 2025 verfügbar | New product in 9 mm thickness available during 2025

i Das Produkt zeigt die individuellen Designmöglichkeiten auf in jeder Verpackung. | This product is deliberately mixed in packing to include a random selection of designs.

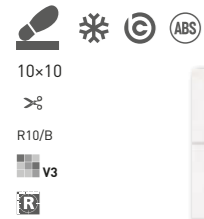

10x10
%
R10/B
v3
R

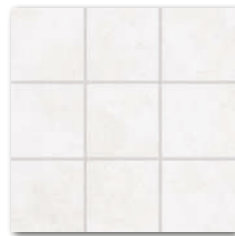

DAK12790* (SHEET)
DAK11790**
PEI 5 ○ 900 l m²
matt
weiß-grau | white-grey



DAK12791* (SHEET)
DAK11791**
PEI 4 ○ 900 l m²
matt
grau | grey

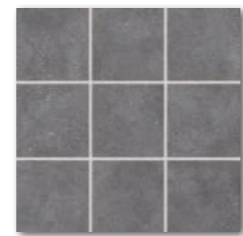

DAK12792* (SHEET)
DAK11792**
PEI 4 ○ 900 l m²
matt
schwarz | black



DAK12793* (SHEET)
DAK11793**
PEI 5 ○ 900 l m²
matt
hellbeige | light beige



DAK12794* (SHEET)
DAK11794**
PEI 4 ○ 900 l m²
matt
dunkelbeige | dark beige

5x5 | 30x30
%
R10/B
v3
R

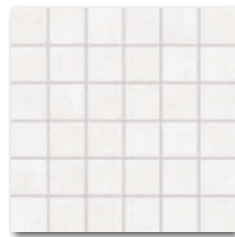

DDM06790* (SHEET)
DDM05790**
PEI 5 ○ 300 l Netz
matt
weiß-grau | white-grey

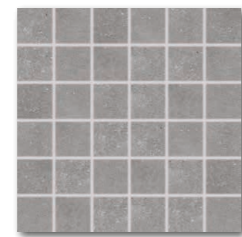

DDM06791* (SHEET)
DDM05791**
PEI 4 ○ 300 l Netz
matt
grau | grey

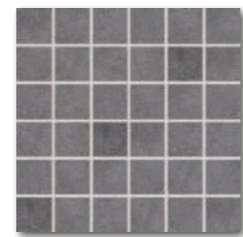

DDM06792* (SHEET)
DDM05792**
PEI 4 ○ 300 l Netz
matt
schwarz | black



DDM06793* (SHEET)
DDM05793**
PEI 5 ○ 300 l Netz
matt
hellbeige | light beige



DDM06794* (SHEET)
DDM05794**
PEI 4 ○ 300 l Netz
matt
dunkelbeige | dark beige

Produkt product	cm	mm	EN	St/m ²	kg/m ²	St/m ²	kg/m ²	St/m ²	kg/m ²	St/m ²	kg/m ²
Bodenfliese floor tile*	10x10	98x98x10	EN 14411 - G Bla	10	11	0,91	56	50,96	19,9	21,9	1.142
Bodenfliese floor tile**	10x10	98x98x9	EN 14411 - G Bla	11	11	1,00	56	56,00	19,2	19,2	1.125
Mosaik set 30x30 cm mosaic sheet 30x30 cm*	5x5	48x48x10	EN 14411 - G Bla	3	11	0,27	-	-	5,9	-	-
Mosaik 30x30 cm mosaic sheet 30x30 cm**	5x5	48x48x9	EN 14411 - G Bla	3	11	0,27	-	-	5,2	-	-
Stufe step tile*	30x120	298x1198x10	EN 14411 - G Bla	3/5	2,8	1,08/1,8	-	-	24,6/40,9	22,7	-
Stufe step tile**	30x120	298x1198x9	EN 14411 - G Bla	3	2,8	1,08	-	-	22,5	-	-
Stufe step tile	40x80	398x798x10	EN 14411 - G Bla	2	3,1	0,64	-	-	14,1	-	-
Stufe step tile*	30x60	298x598x10	EN 14411 - G Bla	6	5,6	1,08	-	-	23,7	-	-
Stufe step tile**	30x60	298x598x9	EN 14411 - G Bla	5	5,6	0,90	-	-	17,3	-	-
Socket skirting plinth*	120x7	1198x70x10	EN 14411 - G Bla	10	11,9	0,84	-	-	19,1	-	-
Socket skirting plinth**	120x7,2	1198x72x9	EN 14411 - G Bla	11	11,9	0,93	-	-	20,4	-	-
Socket skirting plinth	80x9,5	798x95x10	EN 14411 - G Bla	10	13,2	0,76	-	-	16,7	-	-
Socket skirting plinth*	60x9,5	598x95x10	EN 14411 - G Bla	13	17,5	0,74	-	-	16,2	-	-
Socket skirting plinth**	60x7,2	598x72x9	EN 14411 - G Bla	14	23,1	0,60	-	-	11,5	-	-
Socket skirting plinth	45x8,5	448x85x8	EN 14411 - G Bla	25	26,1	0,96	-	-	16,7	-	-
Hohlkehlsokkel cove skirting	30x11	298x110x8	STO No. 030 - 059824	35	30	1,17	-	-	19,3	-	-
Stufenformteil special step tile*	30x120	298x1198x10	STO No. 030 - 059824	2	-	-	-	-	-	-	-
Stufenformteil special step tile**	30x120	298x1198x9	STO No. 030 - 059824	2	-	-	-	-	-	-	-



30x120
R10/B
v3
R

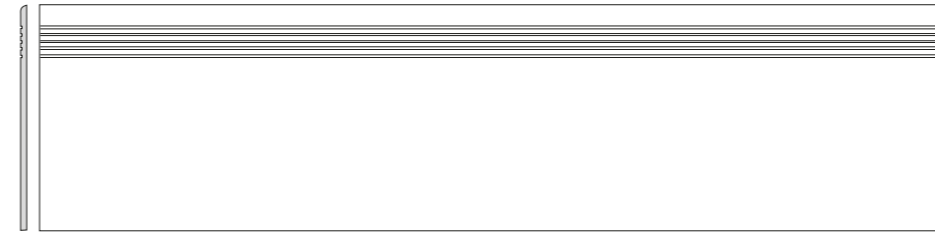

DCPVF790* | **DCPVD790**** weiß-grau | white-grey
DCPVF791* | **DCPVD791**** grau | grey
DCPVF792* | **DCPVD792**** schwarz | black
DCPVF793* | **DCPVD793**** hellbeige | light beige
DCPVF794* | **DCPVD794**** dunkelbeige | dark beige
PEI 4-5 ○ 740 l St
matt

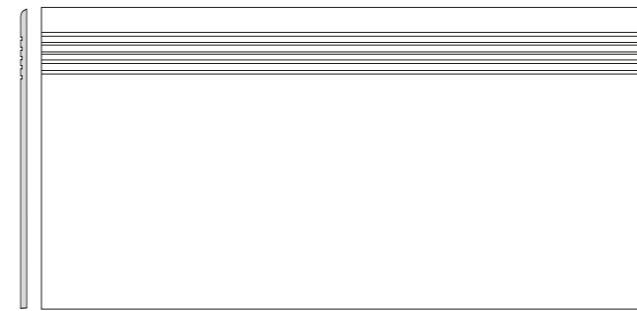

DCP84790 weiß-grau | white-grey
DCP84791 grau | grey
DCP84792 schwarz | black
DCP84793 hellbeige | light beige
DCP84794 dunkelbeige | dark beige
PEI 4-5 ○ 380 l St
matt

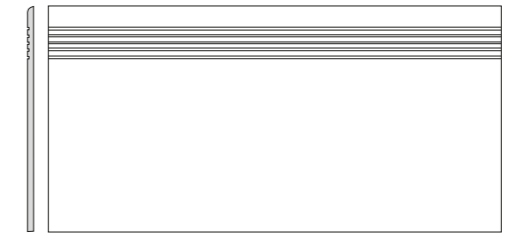

DCPSE790* | **DCPSR790**** weiß-grau | white-grey
DCPSE791* | **DCPSR791**** grau | grey
DCPSE792* | **DCPSR792**** schwarz | black
DCPSE793* | **DCPSR793**** hellbeige | light beige
DCPSE794* | **DCPSR794**** dunkelbeige | dark beige
PEI 4-5 ○ 270 l St
matt

40x80
30x60
R10/B
v3
R



DSA97790* | **DSA99790**** weiß-grau | white-grey
DSA97791* | **DSA99791**** grau | grey
DSA97792* | **DSA99792**** schwarz | black
DSA97793* | **DSA99793**** hellbeige | light beige
DSA97794* | **DSA99794**** dunkelbeige | dark beige
○ 380 l St
matt

120x7*
120x7,2**
R



DSA89790 weiß-grau | white-grey
DSA89791 grau | grey
DSA89792 schwarz | black
DSA89793 hellbeige | light beige
DSA89794 dunkelbeige | dark beige
○ 210 l St
matt



DSAS4790* | **DSAS3790**** weiß-grau | white-grey
DSAS4791* | **DSAS3791**** grau | grey
DSAS4792* | **DSAS3792**** schwarz | black
DSAS4793* | **DSAS3793**** hellbeige | light beige
DSAS4794* | **DSAS3794**** dunkelbeige | dark beige
○ 180 l St
matt

80x9,5
60x9,5*
60x7,2**
R



DSAPS790 weiß-grau | white-grey
DSAPS791 grau | grey
DSAPS792 schwarz | black
DSAPS793 hellbeige | light beige
DSAPS794 dunkelbeige | dark beige
○ 160 l St
matt



DSPJT790 weiß-grau | white-grey
DSPJT791 grau | grey
DSPJT792 schwarz | black
DSPJT793 hellbeige | light beige
DSPJT794 dunkelbeige | dark beige
○ 200 l St
matt

45x8,5
30x11

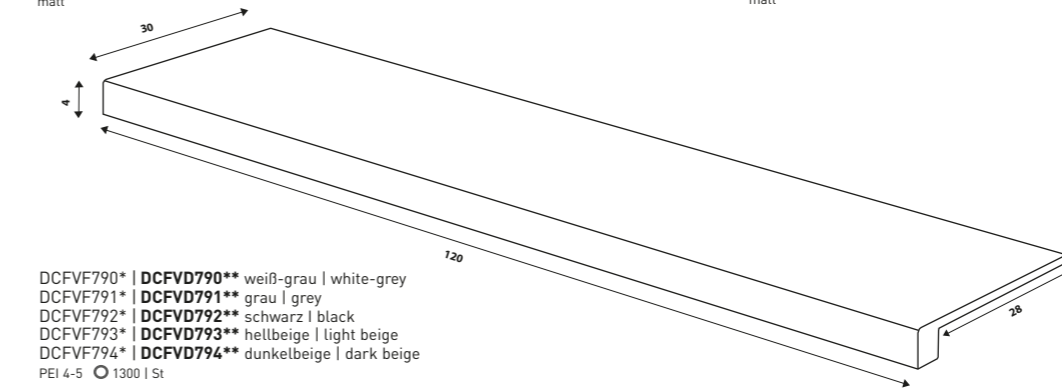

DCFVF790* | **DCFVD790**** weiß-grau | white-grey
DCFVF791* | **DCFVD791**** grau | grey
DCFVF792* | **DCFVD792**** schwarz | black
DCFVF793* | **DCFVD793**** hellbeige | light beige
DCFVF794* | **DCFVD794**** dunkelbeige | dark beige
PEI 4-5 ○ 1300 l St
matt

30x120
R10/B
v3
R

* Verfügbar solange der Vorrat reicht | Available while stocks last

** Neues Produkt in 9 mm Stärke im Laufe des Jahres 2025 verfügbar | New product in 9 mm thickness available during 2025



60x120

R11/B

v3

R

20mm



DARV6790
PEI 5 ○ 850 l m²
relief matt
weiß-grau | white-grey



DAR66791
PEI 4 ○ 850 l m²
relief matt
grau | grey



DARV6792
PEI 4 ○ 850 l m²
relief matt
schwarz | black



60x120

R11/B

v3

R

20mm



DARV6793
PEI 5 ○ 850 l m²
relief matt
hellbeige | light beige



DARV6794
PEI 4 ○ 850 l m²
relief matt
dunkelbeige | dark beige

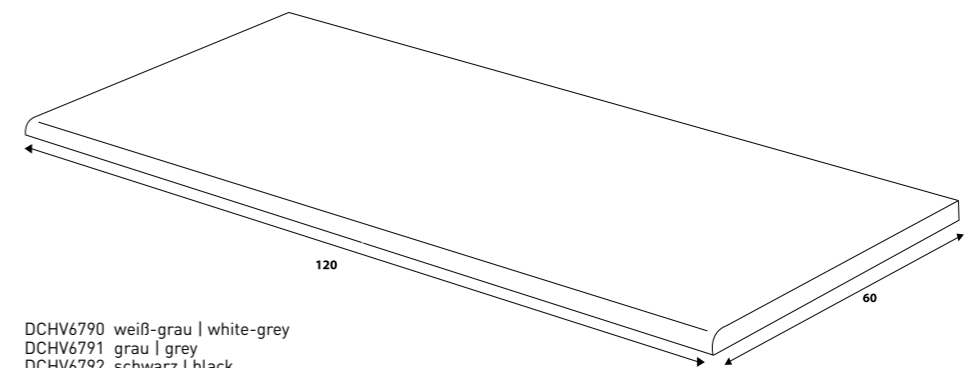

DCHV6790 weiß-grau | white-grey
DCHV6791 grau | grey
DCHV6792 schwarz | black
DCHV6793 hellbeige | light beige
DCHV6794 dunkelbeige | dark beige
PEI 4-5 ○ 1150 l St
relief matt

Produkt | product



Produkt product	cm	mm	EN	St/m ²	m ²	m ²	kg	kg/m ²	brutto kg		
Bodenfliese floor tile	60x120	598x1198x20	EN 14411 - G Bla	1	1,4	0,72	30	21,60	32,5	45,1	999
Stufe step tile	60x120	598x1198x20	EN 14411 - G Bla	1	-	-	-	-	32,5	-	-

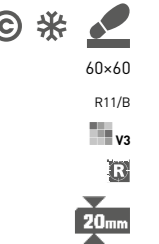

DAR66790
PEI 5 \bigcirc 760 l m²
relief matt
weiß-grau | white-grey



DAR66793
PEI 5 \bigcirc 760 l m²
relief matt
hellbeige | light beige



DAR66791
PEI 4 \bigcirc 760 l m²
relief matt
grau | grey



DAR66794
PEI 4 \bigcirc 760 l m²
relief matt
dunkelbeige | dark beige

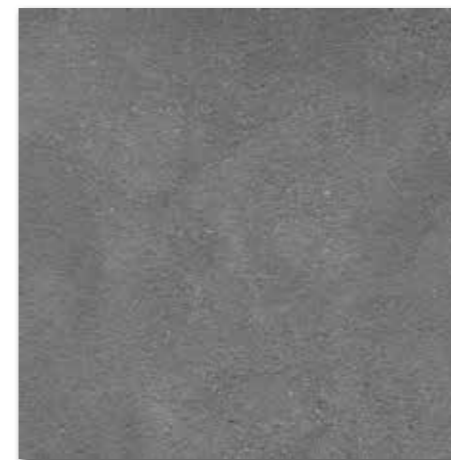

DAR66792
PEI 4 \bigcirc 760 l m²
relief matt
schwarz | black

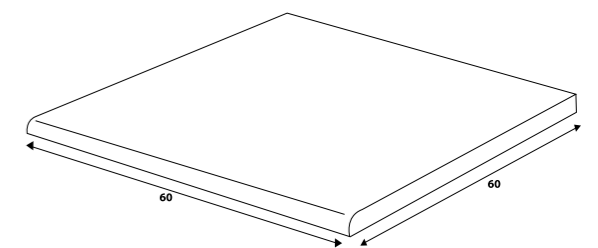

DCH66790 weiß-grau | white-grey
DCH66791 grau | grey
DCH66792 schwarz | black
DCH66793 hellbeige | light beige
DCH66794 dunkelbeige | dark beige
PEI 4-5 \bigcirc 780 l St
relief matt

Produkt | product



Produkt product	cm	mm	EN	St/m ²	m ²	kg	kg/m ²	brutto kg			
Bodenfliese floor tile	60-60	598-598-20	EN 14411 - G Bla	2	2,8	0,72	30	21,6	32,5	45,1	999
Stufe step tile	60-60	598-598-20	EN 14411 - G Bla	2	-	-	-	-	32,5	-	-

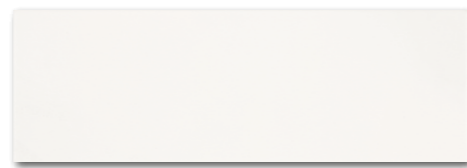

WADVE805
 ○ 510 | m²
 matt
 weiß | white

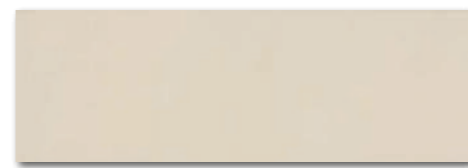

WADVE806
 ○ 510 | m²
 matt
 beige | beige

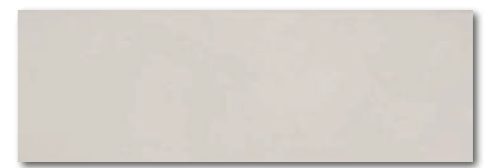

WADVE807
 ○ 510 | m²
 matt
 grau | grey

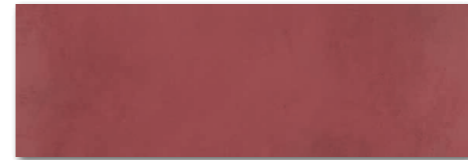

WADVE810
 ○ 510 | m²
 matt



WADVE811
 ○ 510 | m²
 matt



WITVE805
 ○ 350 | St
 matt
 mehrfarbig | multicoloured

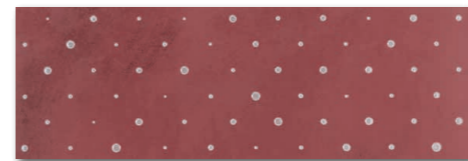

WITVE810
 ○ 350 | St
 matt
 bordo | bordo



WITVE811
 ○ 350 | St
 matt
 blau | blue

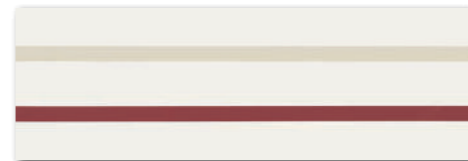

WITVE806
 ○ 350 | St
 matt
 mehrfarbig | multicoloured



WITVE807
 ○ 350 | St
 matt
 mehrfarbig | multicoloured

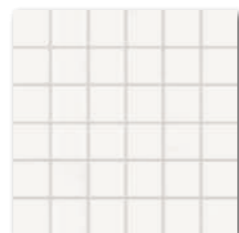

WDM06805 (SHEET)
 ○ 250 | Netz
 matt
 weiß | white

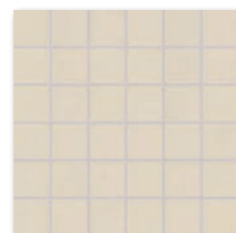

WDM06806 (SHEET)
 ○ 250 | Netz
 matt
 beige | beige

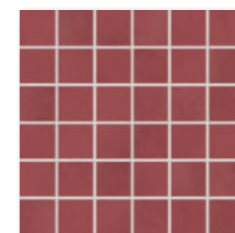

WDM06810 (SHEET)
 ○ 250 | Netz
 matt
 bordo | bordo



WDM06807 (SHEET)
 ○ 250 | Netz
 matt
 grau | grey

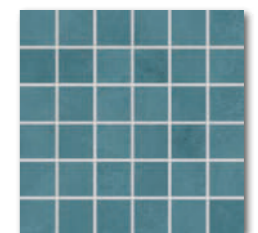

WDM06811 (SHEET)
 ○ 250 | Netz
 matt
 blau | blue



20x60



5x5 | 30x30

Produkt | product



Produkt product	cm	mm	EN	mm	St/m ²	kg/m ²	kg	kg/m ²	kg		
Wandfliese wall tile	20x60	198x598x10	EN 14411 - L BIII	9	8,3	1,08	42	45,36	20,0	18,5	865
Dekor decor	20x60	198x598x10	EN 14411 - L BIII	4	8,3	0,48	-	-	9,0	18,5	-
Mosaik set 30x30 cm mosaic sheet 30x30 cm	5x5	48x48x10	STO No. 030 - 059826	3	11	0,27	-	-	4,7	18,5	-

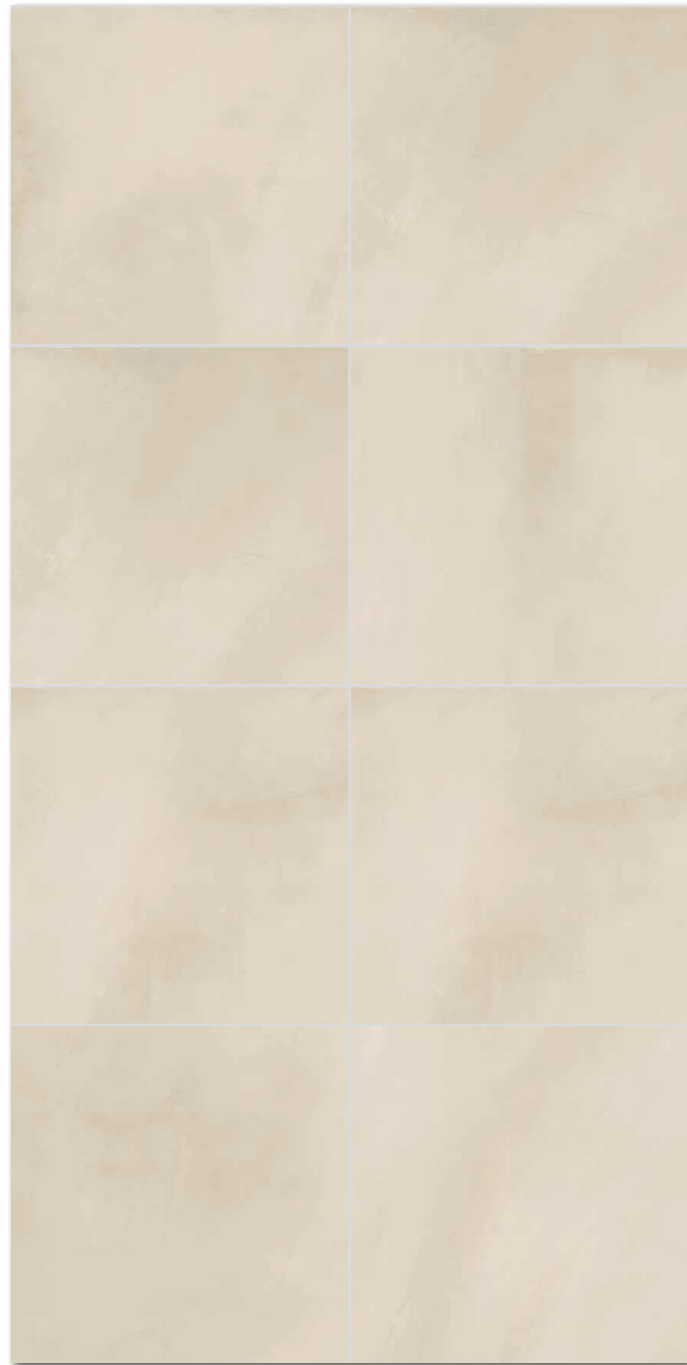

DAK63805
PEI 5 ○ 560 | m²
matt



DAA4H805
PEI 5 ○ 510 | m²
matt

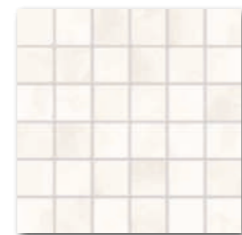

DDM06805 (SHEET)
PEI 5 ○ 300 | Netz
matt
weiß | white

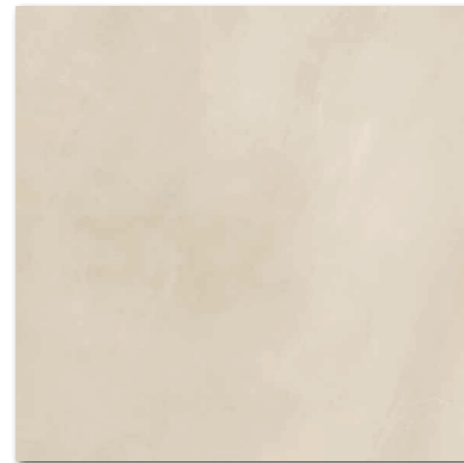

DAK63806
PEI 4 ○ 560 | m²
matt

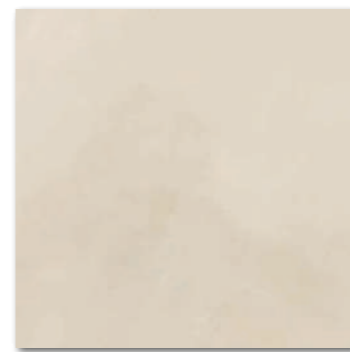

DAA4H806
PEI 4 ○ 510 | m²
matt



DDM06806 (SHEET)
PEI 4 ○ 300 | Netz
matt
beige | beige



DAK63807
PEI 4 ○ 560 | m²
matt



DAA4H807
PEI 4 ○ 510 | m²
matt

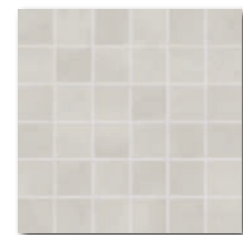

DDM06807 (SHEET)
PEI 4 ○ 300 | Netz
matt
grau | grey

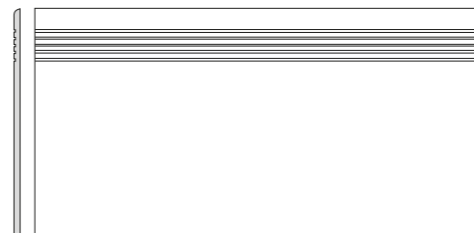

DCPSE805 weiß | white
DCPSE806 beige | beige
DCPSE807 grau | grey
PEI 4-5 ○ 270 | St
matt



DSAS4805 weiß | white
DSAS4806 beige | beige
DSAS4807 grau | grey
○ 180 | St
matt |



DSAPS805 weiß | white
DSAPS806 beige | beige
DSAPS807 grau | grey
○ 160 | St
matt

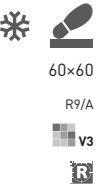

60x60
R9/A
V3
R10/A
R11

45x45
R9/A
V3

5x5 | 30x30
R10/A
V3
R11

30x60
R9/A
V3
R11

60x9,5
45x8,5

Die Fliesen der Serie zeichnen sich durch ein breites Farbspiel V3 aus. | All products of the entire batch show big deviations in shade difference V3.

Wir empfehlen, einzelne Fliesen aus mehreren Paketen herauszunehmen und den gesamten Bodenbelag nach der Inspirationsfotodokumentation in den Katalogen RAKO, eventuell den Webseiten www.rako.eu, zu komponieren. Wünschenswert ist die Kombination aller Fliesendesigns einschließlich ihrer Drehung um 90° oder 180°, sodass ausgewogene Optik der verlegten Fläche erzielt wird.

Before laying the tiles, we suggest you select from several cartons and arrange them as illustrated in the inspiration photo documentation in RAKO catalogues or website www.rako.eu, and mix the tiles to achieve the required result including turning them by 90° or 180°.

Produkt product	cm	mm	EN	St/m ²	kg/m ²	St/m ²	kg/m ²	St/m ²	kg/m ²	St/m ²	kg/m ²
Bodenfliese floor tile	60x60	598x598x10	EN 14411 - G Bla	3	2,8	1,08	32	34,56	23,7	21,9	782
Bodenfliese floor tile	45x45	448x448x8	EN 14411 - G Bla	6	5	1,21	34	41,14	21,1	17,4	741
Mosaik set 30x30 cm mosaic sheet 30x30 cm	5x5	48x48x10	EN 14411 - G Bla	3	11	0,27	-	-	5,9	21,9	-
Stufe step tile	30x60	298x598x10	EN 14411 - G Bla	6	5,6	1,08	-	-	23,7	21,9	-
Sockel skirting plinth	60x9,5	598x95x10	EN 14411 - G Bla	13	17,5	0,74	-	-	16,2	21,9	-
Sockel skirting plinth	45x8,5	448x85x8	EN 14411 - G Bla	25	26,1	0,96	-	-	16,7	17,4	-

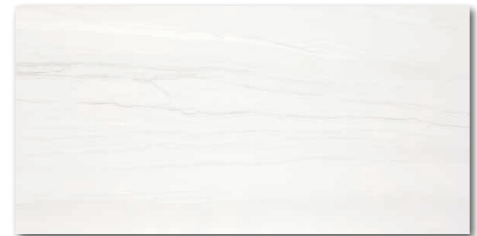

WAKVK525
○ 500 l m²
matt



WAKVK526
○ 500 l m²
matt

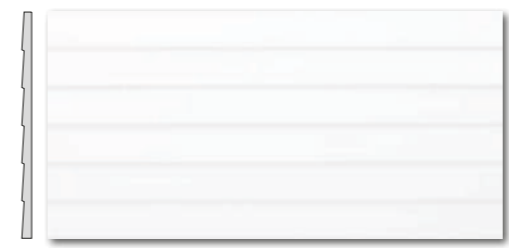

WR1VK104
○ 500 l m²
relief matt

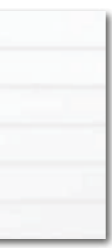

WR1VK000
○ 500 l m²
relief glossy

30x60
v3
R

30x60
v2
R



WDM0U525 (SHEET)
○ 760 l Netz
matt
weiß | white

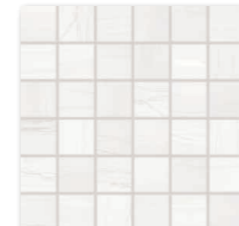

WDM05525 (SHEET)
○ 250 l Netz
matt



WDM0U526 (SHEET)
○ 760 l Netz
matt
hellgrau | light grey



WDM05526 (SHEET)
○ 250 l Netz
matt

2,5x2,5 | 30x30
5x5 | 30x30
v3
R

Produkt product	cm	mm	EN	St/m ²	kg/m ²	mm	mm	mm	mm	kg/m ²	brutto kg
Wandfliese wall tile	30x60	298x598x8	EN 14411 - L BIII	8	5,56	1,44	40	57,60	21,3	14,8	876
Mosaik set 30x30 cm mosaic sheet 30x30 cm	2,5x2,5	23x23x8	STO No. 030 - 059826	4	11	0,36	-	-	5,0	14,8	-
Mosaik set 30x30 cm mosaic sheet 30x30 cm	5x5	48x48x8	STO No. 030 - 059826	4	11	0,36	-	-	5,2	14,8	-

Wir empfehlen die Kombination mit den Fliesen der Serien Board, Extra und Saloon. | To combine with Board, Extra and Saloon floor tiles is recommended.

board

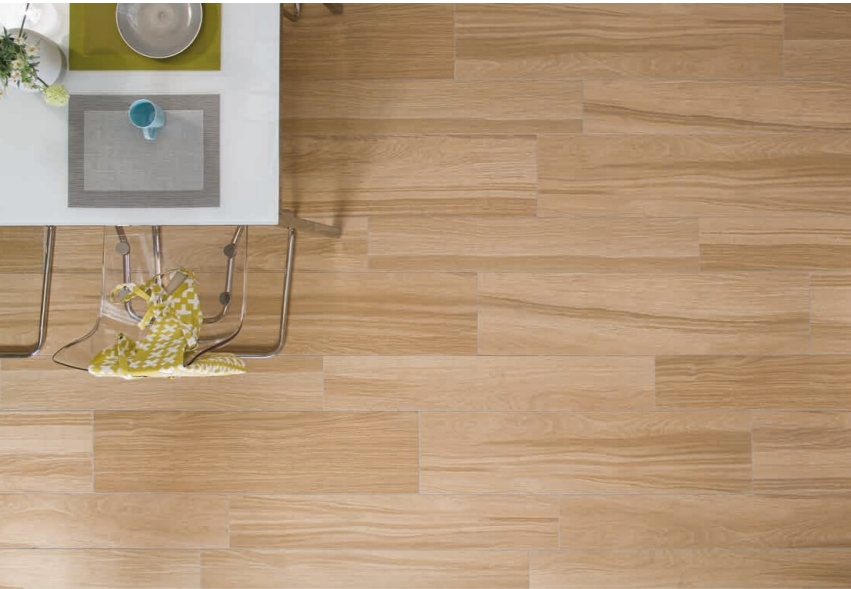

board



RAKO Home



30x120
R9/A
v4
R



DAKVF141
PEI 5 ○ 820 l m²
matt

20x120
R9/A
v4
R

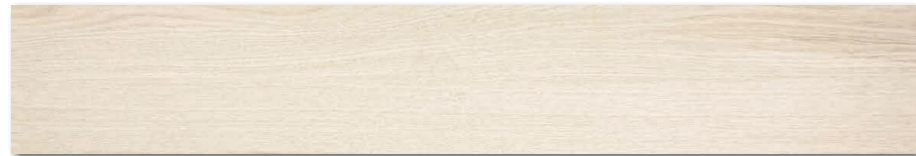

DAKVG141
PEI 5 ○ 820 l m²
matt
hellbeige | light beige

30x120
R9/A
v4
R



DAKVF142
PEI 4 ○ 820 l m²
matt

20x120
R9/A
v4
R

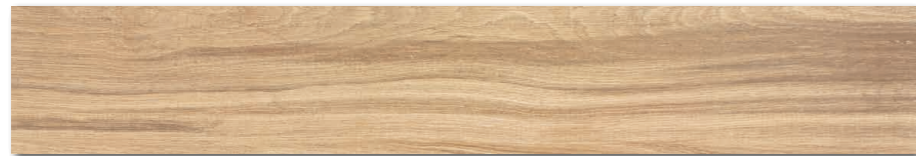

DAKVG142
PEI 4 ○ 820 l m²
matt
beige | beige

30x120
R9/A
v4
R



DAKVF143
PEI 4 ○ 820 l m²
matt

20x120
R9/A
v4
R

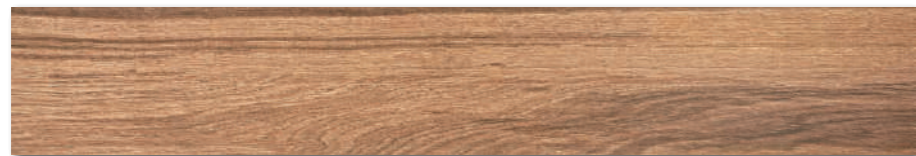

DAKVG143
PEI 4 ○ 820 l m²
matt
braun | brown

Produkt | product



Bodenfliese | floor tile
Bodenfliese | floor tile
Dekor | decor

30x120

298x1198x10

EN 14411 - G Bla

3

2,8

1,08

40

43,2

24,5

22,7

1 006

20x120

198x1198x10

EN 14411 - G Bla

4

4,2

0,96

32

30,72

21,8

22,7

723

20x120

198x1198x10

EN 14411 - G Bla

4

4,2

0,96

-

-

21,8

22,7

-



30x120
R9/A
v4
R



DAKVF144
PEI 4 ○ 820 l m²
matt

20x120
R9/A
v4
R



DAKVG144
PEI 4 ○ 820 l m²
matt
dunkelbraun | dark brown

30x120
R9/A
v4
R



DAKVF140
PEI 5 ○ 820 l m²
matt

20x120
R9/A
v4
R



DAKVG140
PEI 5 ○ 820 l m²
matt
hellgrau | light grey

20x120
R9/A
v4
R

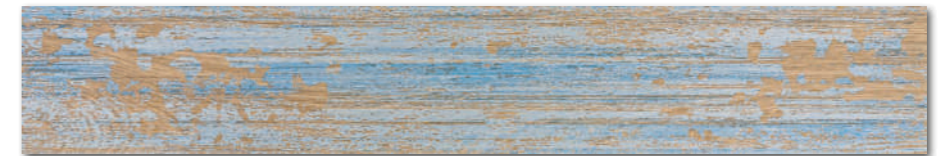

DDTVG467
PEI 4 ○ 1150 l St
matt
beige-türkis | beige-turquoise

20x120
R9/A
v4
R



DDTVG023
PEI 4 ○ 1150 l St
matt
hellbeige-weiß | light beige-white

Empfohlene Formatkombinationen siehe Seite 522-523. | Recommended combinations of modular sizes see pages 522-523.



Die Fliesen der Serie zeichnen sich durch ein breites Farbspiel V4 aus. | All products of the entire batch show big deviations in shade difference V4.

Wir empfehlen, einzelne Fliesen aus mehreren Paketen herauszunehmen und den gesamten Bodenbelag nach der Inspirationsfotodokumentation in den Katalogen RAKO, eventuell den Webseiten www.rako.eu, zu komponieren. Wünschenswert ist die Kombination aller Fliesendesigns einschließlich ihrer Drehung um 180°, sodass ausgewogene Optik der verlegten Fläche erzielt wird.

Before laying the tiles, we suggest you select from several cartons and arrange them as illustrated in the inspiration photo documentation in RAKO catalogues or website www.rako.eu, and mix the tiles to achieve the required result including turning them by 180°.

30x120

R9/A
V4
R

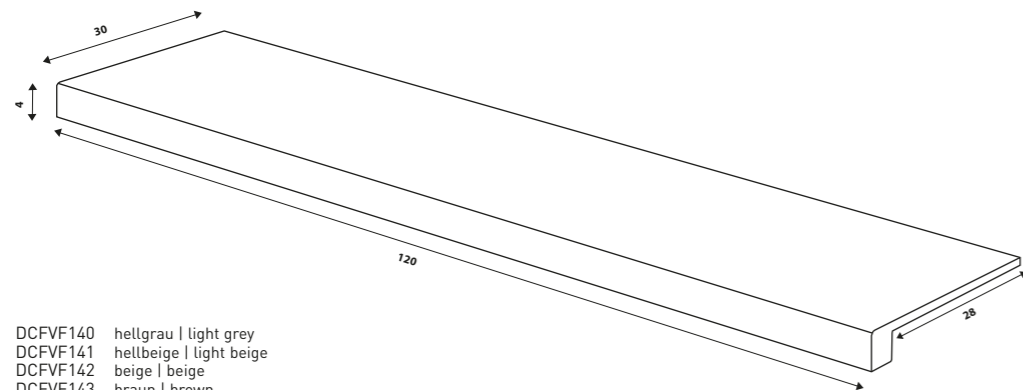

DCFVF140 hellgrau | light grey
DCFVF141 hellbeige | light beige
DCFVF142 beige | beige
DCFVF143 braun | brown
DCFVF144 dunkelbraun | dark brown
PEI 4-5 ○ 1300 | St
matt

Produkt | product

	cm	mm	EN	St/m ²	kg/m ²	St/m ²	kg/m ²	St/m ²	kg/m ²	St/m ²	kg/m ²
Dekor decor	30x60	298x598x10	EN 14411 - G Bla	4	5,6	0,72	-	-	16,3	22,7	-
Mosaik set 30x30 cm mosaic sheet 30x30 cm	5x5	48x48x10	EN 14411 - G Bla	3	11	0,27	-	-	5,9	22,7	-
Stufe step tile	30x120	298x1198x10	EN 14411 - G Bla	3/5	2,8	1,08/1,8	-	-	24,6/40,9	22,7	-
Sockel skirting plinth	60x9,5	598x95x10	EN 14411 - G Bla	13	17,5	0,74	-	-	16,2	22,7	-
Stufenformteil special step tile	30x120	298x1198x10	STO No. 030 - 059824	2	-	-	-	-	-	-	-

© ❄️ 🖌️
30x60
R10/A
V4
R



DDPSE023 (SHEET)
PEI 4 ○ 840 | Netz
matt
mehrfarbig | multicoloured



DDPSE467 (SHEET)
PEI 4 ○ 840 | Netz
matt



DDM06141 (SHEET)
PEI 5 ○ 300 | Netz
matt
hellbeige | light beige

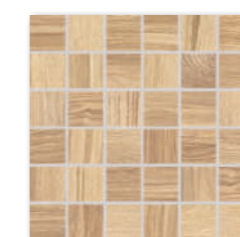

DDM06142 (SHEET)
PEI 4 ○ 300 | Netz
matt
beige | beige

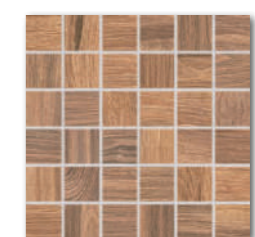

DDM06143 (SHEET)
PEI 4 ○ 300 | Netz
matt
braun | brown

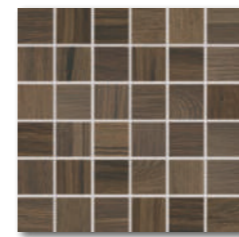

DDM06144 (SHEET)
PEI 4 ○ 300 | Netz
matt
dunkelbraun | dark brown



DDM06140 (SHEET)
PEI 5 ○ 300 | Netz
matt
hellgrau | light grey



DDM06145 (SHEET)
PEI 4 ○ 300 | Netz
matt
mehrfarbig | multicoloured

5x5 | 30x30
R10/A
V4
R

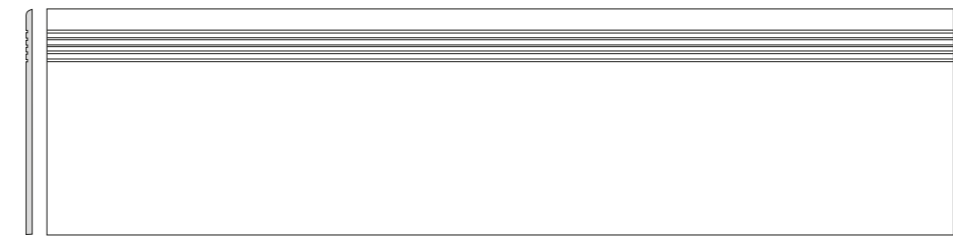

DCPVF140 hellgrau | light grey
DCPVF141 hellbeige | light beige
DCPVF142 beige | beige
DCPVF143 braun | brown
DCPVF144 dunkelbraun | dark brown
PEI 4-5 ○ 740 | St
matt



DSAS4140 hellgrau | light grey
DSAS4141 hellbeige | light beige
DSAS4142 beige | beige
DSAS4143 braun | brown
DSAS4144 dunkelbraun | dark brown
○ 350 | St
matt

30x120
R9/A
V4
R

60x9,5
R





60x120
20x120

R10/B

v3



DAKV1850*
DAKV9850**
PEI 5 ○ 700 l m²
matt

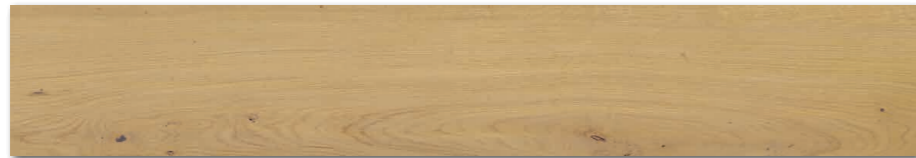

DAKVG850*
DAKVE850**
PEI 5 ○ 820 l m²
matt
color **ale**
beige | beige

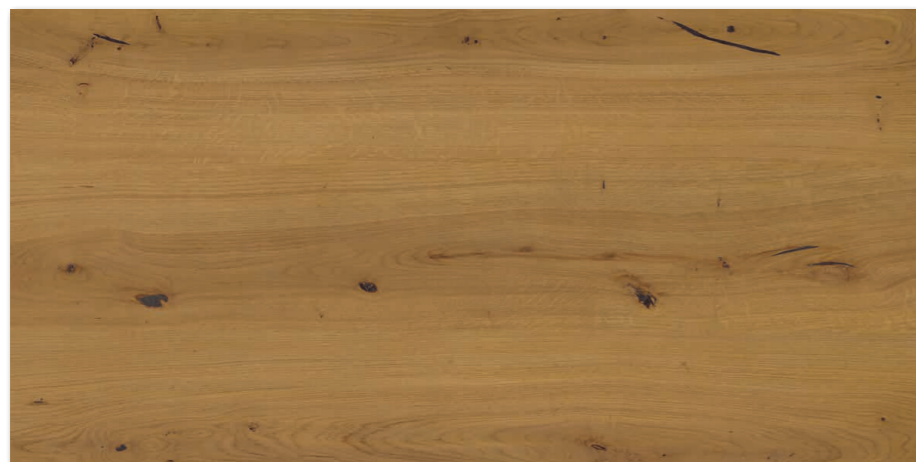

DAKV1851*
DAKV9851**
PEI 4 ○ 700 l m²
matt



DAKVG851*
DAKVE851**
PEI 4 ○ 820 l m²
matt
color **cognac**
braun | brown



60x120
20x120

R10/B

v3



DAKV1852*
DAKV9852**
PEI 4 ○ 700 l m²
matt



DAKVG852*
DAKVE852**
PEI 4 ○ 820 l m²
matt
color **barrique**
dunkelbraun | dark brown

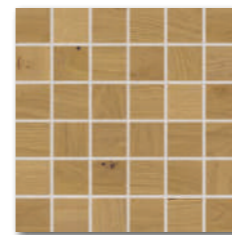

DDM06850* (SHEET)
DDM05850**
PEI 5 ○ 300 | Netz
matt
color **ale**
beige | beige

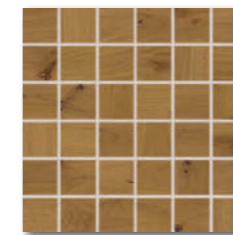

DDM06851* (SHEET)
DDM05851**
PEI 4 ○ 300 | Netz
matt
color **cognac**
braun | brown

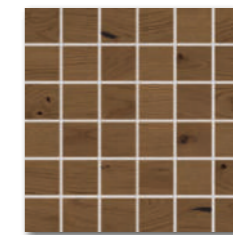

DDM06852* (SHEET)
DDM05852**
PEI 4 ○ 300 | Netz
matt
color **barrique**
dunkelbraun | dark brown

5x5 | 30x30



R10/B

v3



* Verfügbar solange der Vorrat reicht | Available while stocks last

** Neues Produkt in 9 mm Stärke im Laufe des Jahres 2025 verfügbar | New product in 9 mm thickness available during 2025

Produkt product	cm	mm	EN	Stk	Stk/m ²	kg	kg/m ²	kg	kg/m ²	kg	kg/m ²
Bodenfliese floor tile*	60x120	598x1198x10	EN 14411 - G Bla	2	1,4	1,44	27	38,88	32,7	22,7	908
Bodenfliese floor tile**	60x120	598x1198x9	EN 14411 - G Bla	2	1,4	1,44	30	43,20	29,3	20,4	905
Bodenfliese floor tile*	20x120	198x1198x10	EN 14411 - G Bla	4	4,2	0,96	32	30,72	21,8	22,7	723
Bodenfliese floor tile**	20x120	198x1198x9	EN 14411 - G Bla	4	4,2	0,96	32	30,72	19,6	20,4	651
Mosaik 30x30 cm mosaic sheet 30x30 cm*	5x5	48x48x10	EN 14411 - G Bla	3	11	0,27	-	-	6,1	-	-
Mosaik 30x30 cm mosaic sheet 30x30 cm**5x5	5x5	48x48x9	EN 14411 - G Bla	3	11	0,27	-	-	5,2	-	-

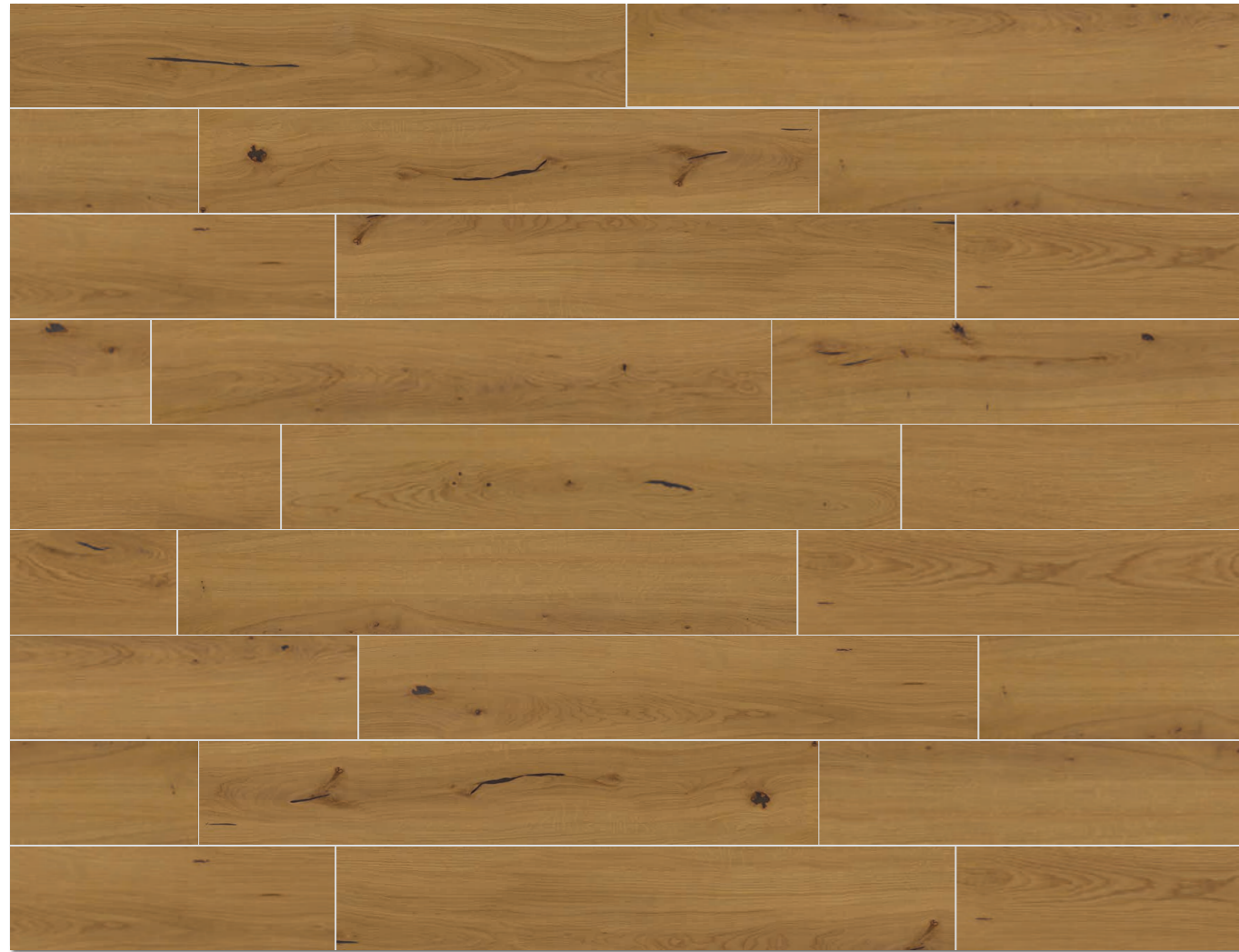

Die Fliesen der Serie zeichnen sich durch ein breites Farbspiel V3 aus. | All products of the entire batch show big deviations in shade difference V3.

Wir empfehlen, einzelne Fliesen aus mehreren Paketen herauszunehmen und den gesamten Bodenbelag nach der Inspirationsfotodokumentation in den Katalogen RAKO, eventuell den Webseiten www.rako.eu, zu komponieren. Wünschenswert ist die Kombination aller Fliesendesigns einschließlich ihrer Drehung um 180°, sodass ausgewogene Optik der verlegten Fläche erzielt wird.

Before laying the tiles, we suggest you select from several cartons and arrange them as illustrated in the inspiration photo documentation in RAKO catalogues or website www.rako.eu, and mix the tiles to achieve the required result including turning them by 180°.



30x120

R10/B

v3

R

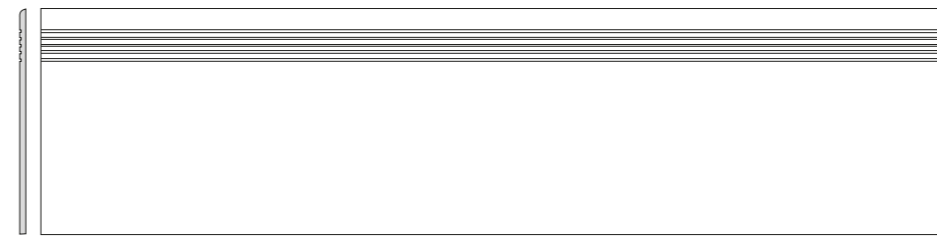

DCPVF850* | **DCPVD850**** color **ale** | beige | beige
 DCPVF851* | **DCPVD851**** color **cognac** | braun | brown
 DCPVF852* | **DCPVD852**** color **barrique** | dunkelbraun | dark brown
 PEI 4-5 ○ 740 | St
 matt

60x7,2

R



DSASP850* | **DSAS3850**** color **ale** | beige | beige
 DSASP851* | **DSAS3851**** color **cognac** | braun | brown
 DSASP852* | **DSAS3852**** color **barrique** | dunkelbraun | dark brown
 ○ 180 | St
 matt

30x120

R10/B

v3

R

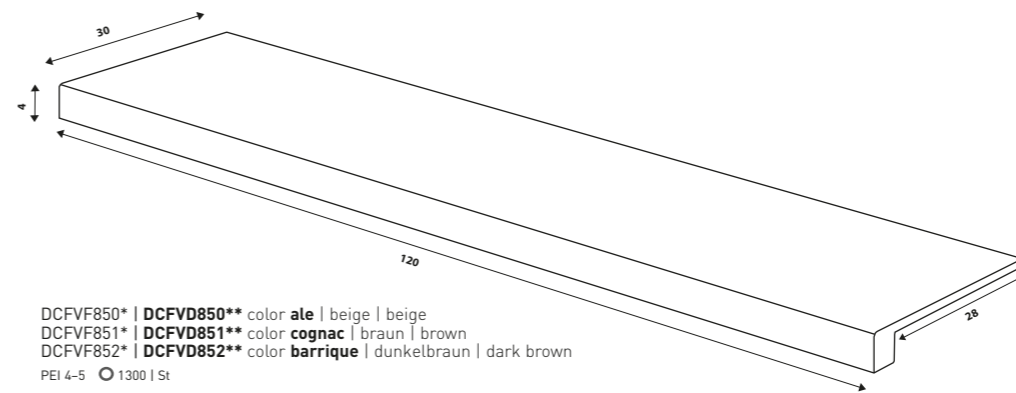

DCFVF850* | **DCFVD850**** color **ale** | beige | beige
 DCFVF851* | **DCFVD851**** color **cognac** | braun | brown
 DCFVF852* | **DCFVD852**** color **barrique** | dunkelbraun | dark brown
 PEI 4-5 ○ 1300 | St
 matt

Produkt product	cm	mm	EN	St/m ²	kg/m ²	kg	kg/m ²	brutto kg
Stufe step tile*	30x120	298x1198-10	EN 14411 - G Bla	3	2,8	1,08	-	24,6
Stufe step tile**	30x120	298x1198-9	EN 14411 - G Bla	3	2,8	1,08	-	22,5
Sockel skirting plinth*	60x7,2	598x72x10	EN 14411 - G Bla	13	23,2	0,56	-	12,7
Sockel skirting plinth**	60x7,2	598x72x9	EN 14411 - G Bla	14	23,1	0,60	-	11,5
Stufenformteil special step tile*	30x120	298x1198-10	STD No. 030 - 059824	2	-	-	-	-
Stufenformteil special step tile**	30x120	298x1198-9	STD No. 030 - 059824	2	-	-	-	-

* Verfügbar solange der Vorrat reicht | Available while stocks last

** Neues Produkt in 9 mm Stärke im Laufe des Jahres 2025 verfügbar | New product in 9 mm thickness available during 2025

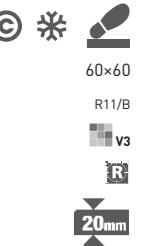

DAR66850
PEI 5 \bigcirc 760 l m²
relief matt
color **ale**
beige | beige



DAR66851
PEI 4 \bigcirc 760 l m²
relief matt
color **cognac**
braun | brown

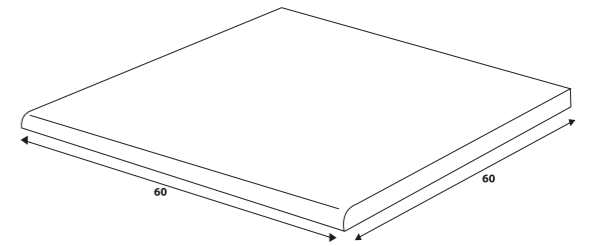

DCH66850 color **ale** | beige | beige
DCH66851 color **cognac** | braun | brown
PEI 4-5 \bigcirc 780 l St
relief matt

Produkt product											
Bodenfliese floor tile	60x60	598x598x20	EN 14411 - G Bla	2	2,8	0,72	30	21,6	32,5	45,1	999
Stufe step tile	60x60	598x598x20	EN 14411 - G Bla	2	-	-	-	-	32,5	-	-





WAKVK858
 ○ 500 l m²
 matt



WAKVK855
 ○ 500 l m²
 matt



WDM05858 (SHEET)
 ○ 250 l Netz
 matt
 color **dune**
 beige | beige

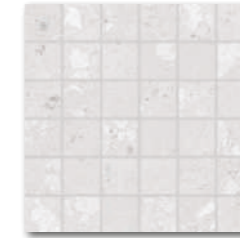

WDM05855 (SHEET)
 ○ 250 l Netz
 matt
 color **paper**
 weiß-grau | white-grey

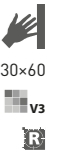

30x60

v3

R

5x5 | 30x30



v3

R

Produkt | product

Wandfliese | wall tile 30x60
 Mosaik 30x30 cm | mosaic sheet 30x30 cm 5x5



EN 14411 - L BIII
 STO No. 030 - 059826



8	5,56	1,44	40	57,60	21,3	14,8	876
4	11	0,36	-	-	5,2	14,8	-



120x120

R10/B

v3

R



DAK92858
 PEI 5 ○ 900 l m²
 matt
 color **dune**
 beige | beige



DAK92855
 PEI 5 ○ 900 l m²
 matt
 color **paper**
 weiß-grau | white-grey



120x120

R10/B

v3

R

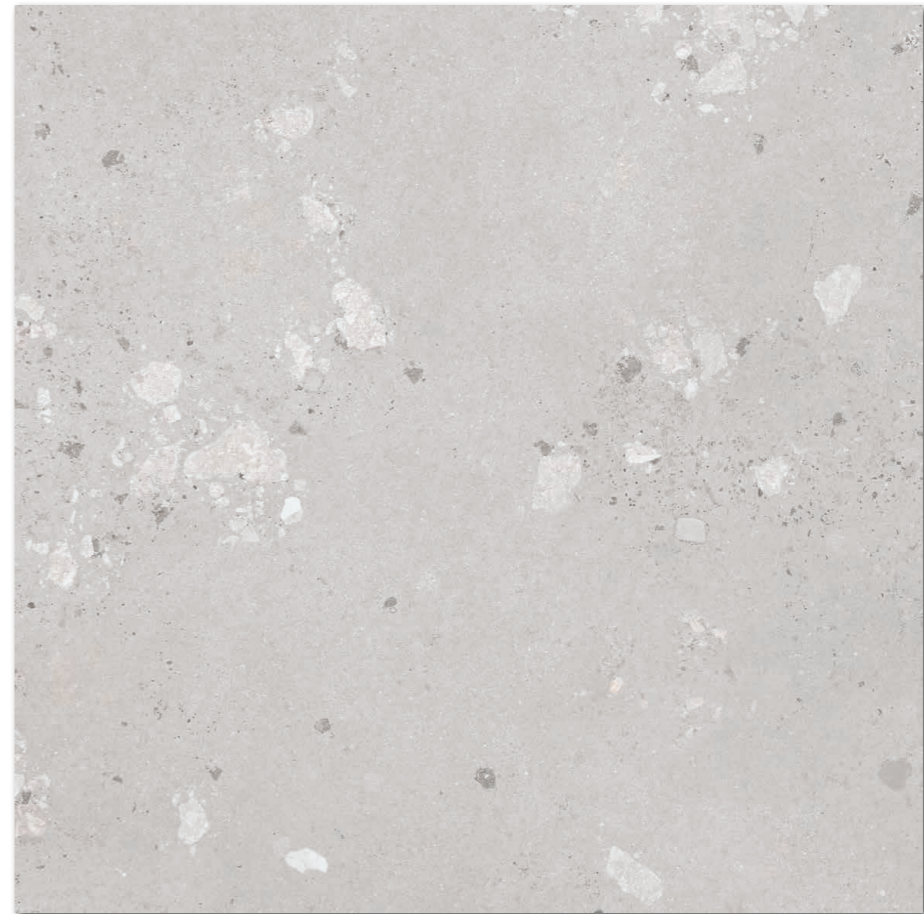

DAK92856
 PEI 5 ○ 900 l m²
 matt
 color **cement**
 grau | grey

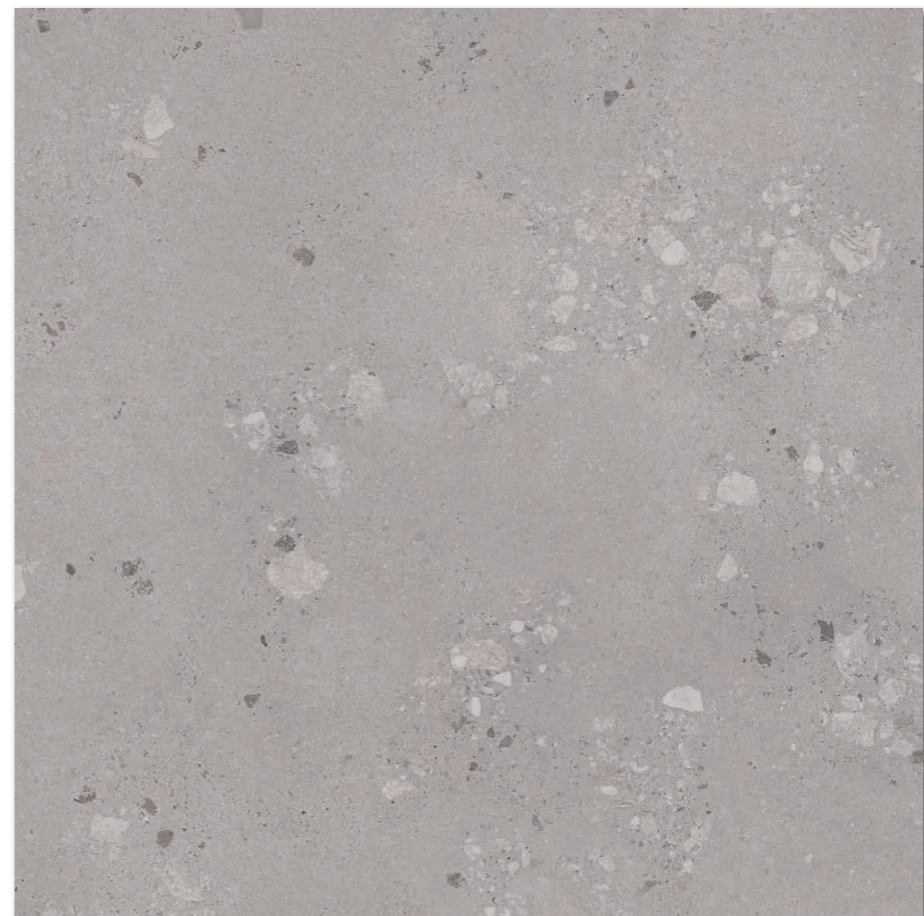

DAK92857
 PEI 4 ○ 900 l m²
 matt
 color **ash**
 dunkelgrau | dark grey

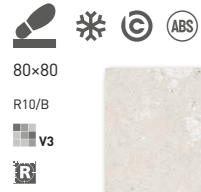

DAK81858
PEI 5 ○ 700 l m²
matt
color **dune**
beige | beige

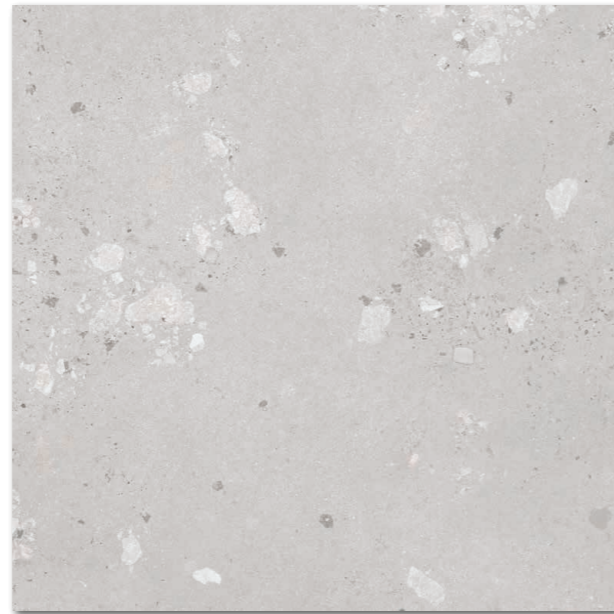

DAK81856
PEI 5 ○ 700 l m²
matt
color **cement**
grau | grey



DAK81855
PEI 5 ○ 700 l m²
matt
color **paper**
weiß-grau | white-grey

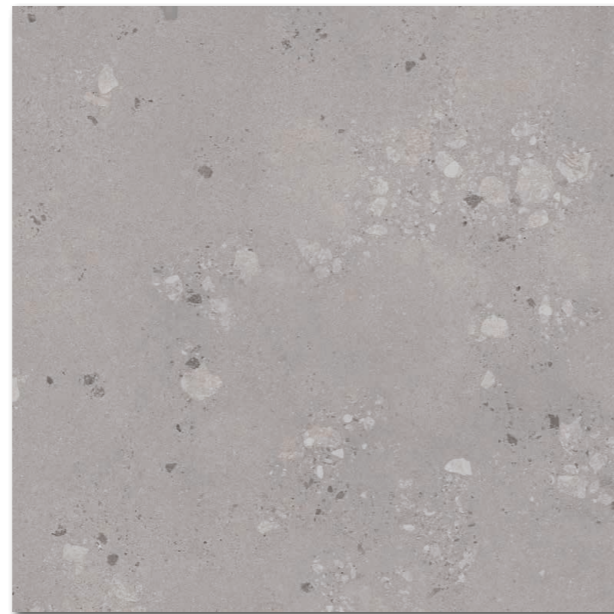

DAK81857
PEI 4 ○ 700 l m²
matt
color **ash**
dunkelgrau | dark grey



DAK62858
PEI 5 ○ 560 l m²
matt
color **dune**
beige | beige

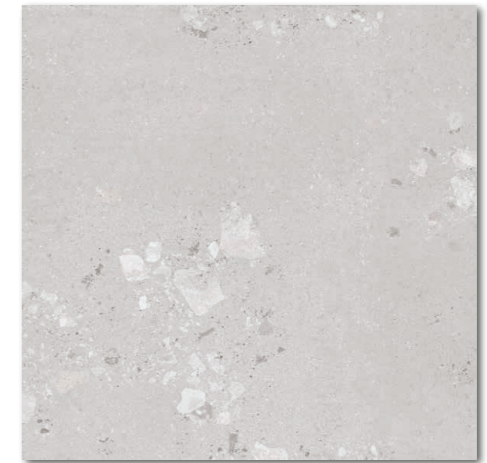

DAK62856
PEI 5 ○ 560 l m²
matt
color **cement**
grau | grey

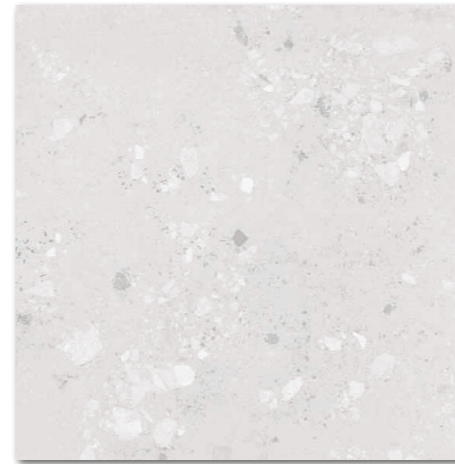

DAK62855
PEI 5 ○ 560 l m²
matt
color **paper**
weiß-grau | white-grey

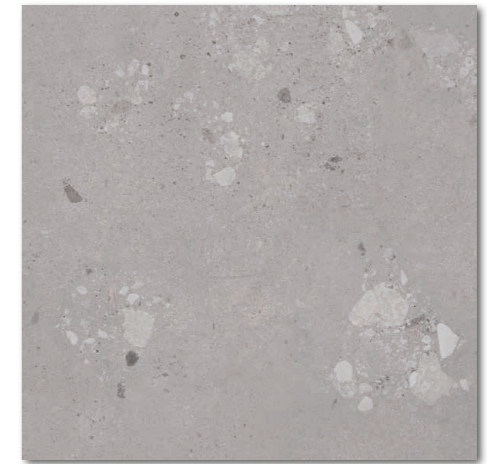

DAK62857
PEI 4 ○ 560 l m²
matt
color **ash**
dunkelgrau | dark grey

Produkt product	cm	mm	EN	Stk/m ²	kg/m ²	kg/m ²	kg/m ²	kg/m ²	kg/m ²	kg/m ²	
Bodenfliese floor tile	120x120	1198x1198x8,5	EN 14411 - G Bla	2	0,7	2,88	24	69,12	53,1	18,9	1 330
Bodenfliese floor tile	80x80	798x798x10	EN 14411 - G Bla	2	1,6	1,28	42	53,76	28,0	21,9	1 202
Bodenfliese floor tile	60x60	598x598x9	EN 14411 - G Bla	4	2,8	1,44	32	46,08	29,1	20,2	955

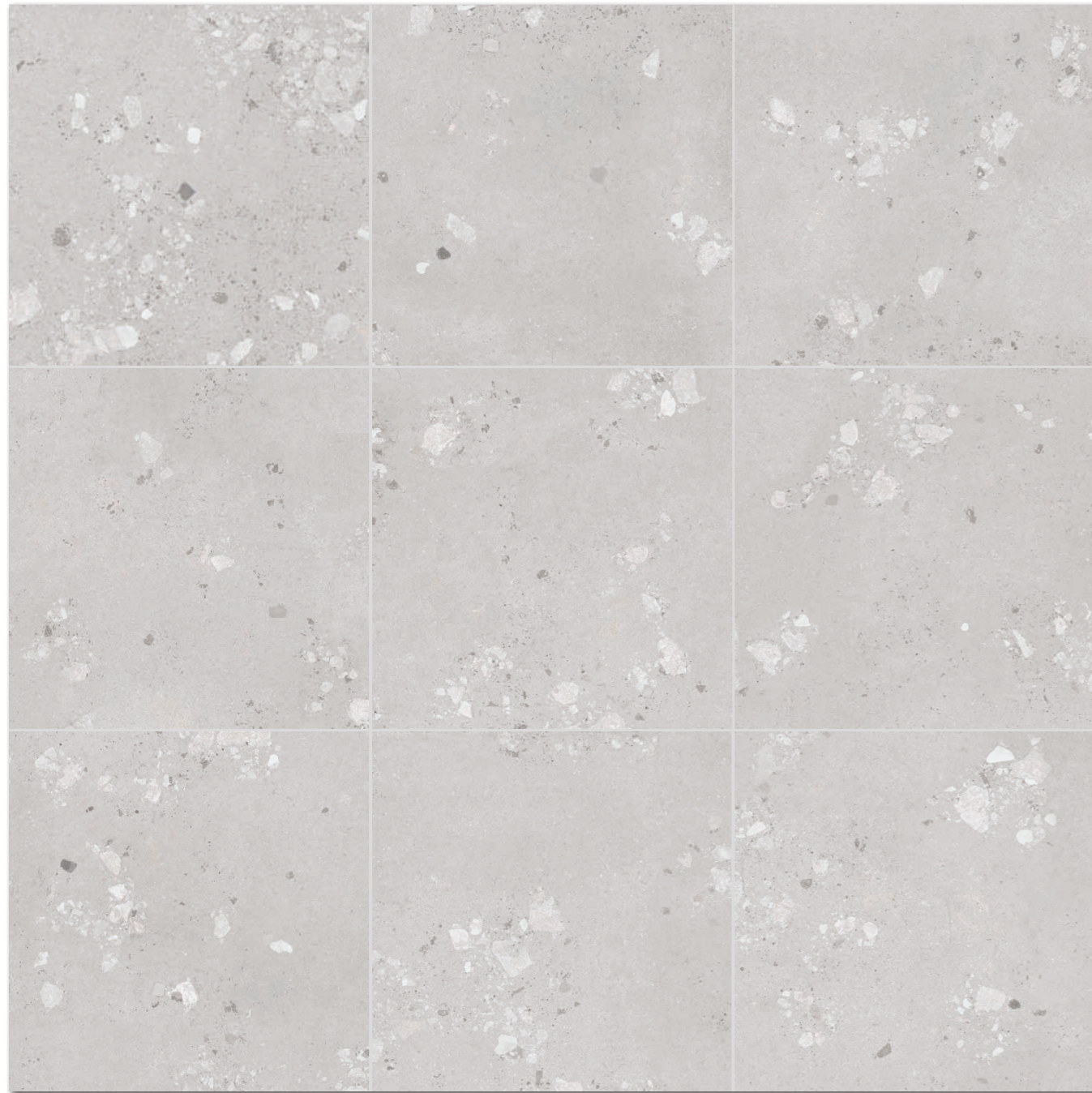

Die Fliesen der Serie zeichnen sich durch ein breites Farbspiel V3 aus. | All products of the entire batch show big deviations in shade difference V3.

Wir empfehlen, einzelne Fliesen aus mehreren Paketen herauszunehmen und den gesamten Bodenbelag nach der Inspirationsfotodokumentation in den Katalogen RAKO, eventuell den Webseiten www.rako.eu, zu komponieren. Wünschenswert ist die Kombinierung aller Fliesendesigns einschließlich ihrer Drehung um 90° oder 180°, sodass ausgewogene Optik der verlegten Fläche erzielt wird.

Before laying the tiles, we suggest you select from several cartons and arrange them as illustrated in the inspiration photo documentation in RAKO catalogues or website www.rako.eu, and mix the tiles to achieve the required result including turning them by 90° or 180°.

Produkt product	cm	mm	EN	St/m ²	kg/m ²	St/m ²	kg/m ²	St/m ²	kg/m ²	St/m ²	kg/m ²
Bodenfliese floor tile	10×10	98×98×9	EN 14411 - G Bla	11	11	1,00	56	56,00	20,2	20,2	1 155
Stufe step tile	60×60	598×597×9	EN 14411 - G Bla	3	2,8	1,08	-	-	21,9	-	-
Stufe step tile	40×80	398×798×10	EN 14411 - G Bla	2	3,1	0,64	-	-	14,1	-	-
Sockel skirting plinth	120×7,2	1198×72×8,5	EN 14411 - G Bla	11	11,9	0,93	-	-	17,6	-	-
Sockel skirting plinth	80×9,5	798×95×10	EN 14411 - G Bla	10	13,2	0,76	-	-	16,7	-	-
Sockel skirting plinth	60×7,2	598×72×9	EN 14411 - G Bla	14	23,1	0,60	-	-	11,5	-	-
Stufenformteil special step tile	40×80	398×798×10	STD No. 030 - 059824	2	-	-	-	-	16,5	-	-



10×10 | 30×30



R10/B



V3



R10/B



DAK11858 (SHEET)
PEI 5 ○ 900 | m²
matt
color **dune**
beige | beige



DAK11855 (SHEET)
PEI 5 ○ 900 | m²
matt
color **paper**
weiß-grau | white-grey

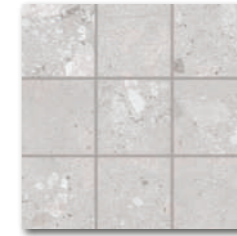

DAK11856 (SHEET)
PEI 5 ○ 900 | m²
matt
color **cement**
grau | grey

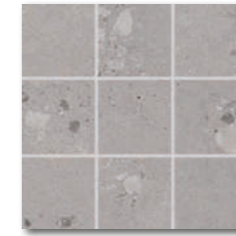

DAK11857 (SHEET)
PEI 4 ○ 900 | m²
matt
color **ash**
dunkelgrau | dark grey

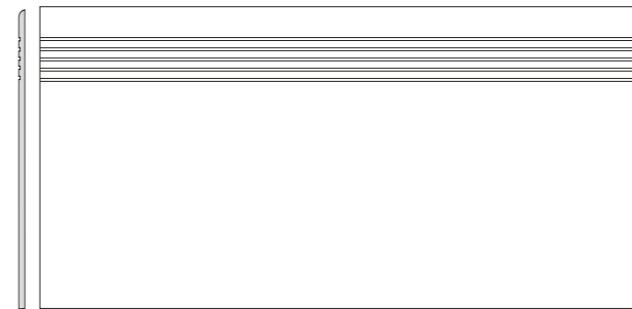

DCP84855 color **paper** | weiß-grau | white-grey
DCP84856 color **cement** | grau | grey
DCP84857 color **ash** | dunkelgrau | dark grey
DCP84858 color **dune** | beige | beige
PEI 4-5 ○ 380 | St
matt

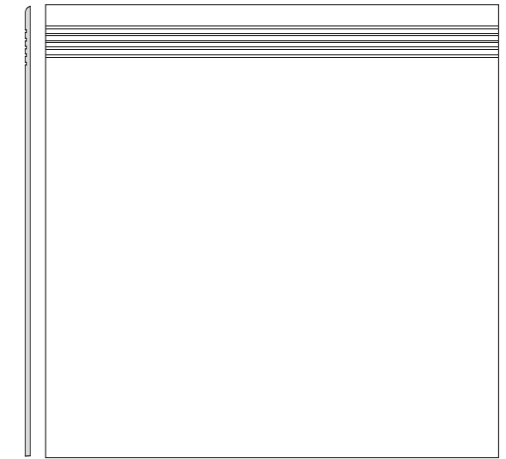

DCP62855 color **paper** | weiß-grau | white-grey
DCP62856 color **cement** | grau | grey
DCP62857 color **ash** | dunkelgrau | dark grey
DCP62858 color **dune** | beige | beige
PEI 4-5 ○ 370 | St
matt



DSA98855 color **paper** | weiß-grau | white-grey
DSA98856 color **cement** | grau | grey
DSA98857 color **ash** | dunkelgrau | dark grey
DSA98858 color **dune** | beige | beige
○ 380 | St
mat | matt



DSA89855 color **paper** | weiß-grau | white-grey
DSA89856 color **cement** | grau | grey
DSA89857 color **ash** | dunkelgrau | dark grey
DSA89858 color **dune** | beige | beige
○ 210 | St
matt



DSAS3855 color **paper** | weiß-grau | white-grey
DSAS3856 color **cement** | grau | grey
DSAS3857 color **ash** | dunkelgrau | dark grey
DSAS3858 color **dune** | beige | beige
○ 180 | St
matt

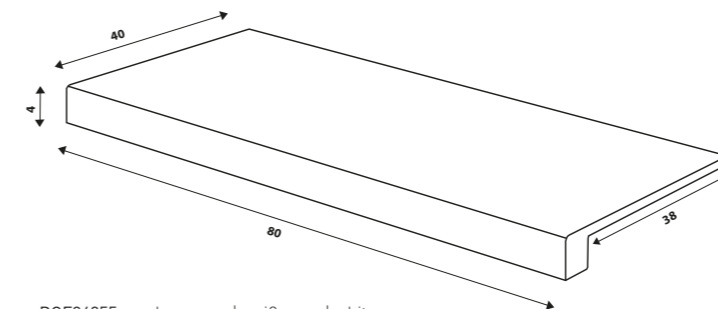

DCF84855 color **paper** | weiß-grau | white-grey
DCF84856 color **cement** | grau | grey
DCF84857 color **ash** | dunkelgrau | dark grey
DCF84858 color **dune** | beige | beige
PEI 4-5 ○ 1130 | St
matt

40×80

60×60



R10/B



V3



R10/B

120×7,2



R10/B

80×9,5

60×7,2



R10/B

40×80

R10/B



V3



R10/B



60x120

R11/B

v3

R

20mm



DARV6858
PEI 5 ○ 850 l m²
relief matt
color **dune**
beige | beige



DARV6856
PEI 5 ○ 850 l m²
relief matt
color **cement**
grau | grey



60x120

R11/B

v3

R

20mm

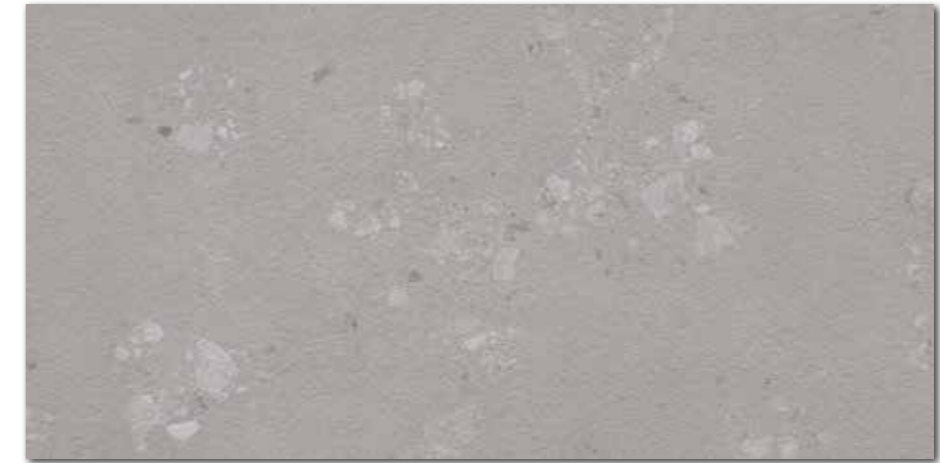

DARV6857
PEI 4 ○ 850 l m²
relief matt
color **ash**
dunkelgrau | dark grey

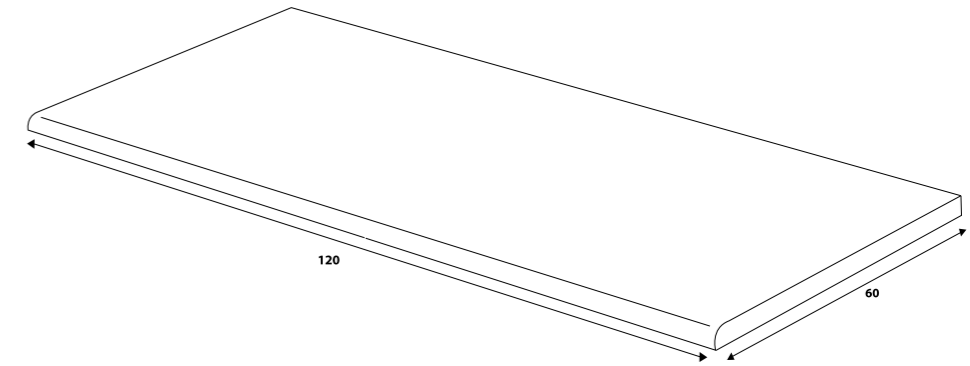

DCHV6856 color **cement** | grau | grey
DCHV6857 color **ash** | dunkelgrau | dark grey
DCHV6858 color **dune** | beige | beige
PEI 4-5 ○ 1150 l St
relief matt

Produkt | product



60x120

60x120

598x1198+20

598x1198+20

EN 14411 - G Bla

EN 14411 - G Bla

1

1,4

0,72

30

21,60

32,5

45,1

999

Bodenfliese | floor tile

Stufe | step tile

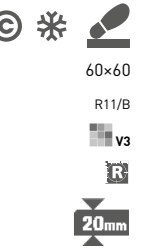

DAR66858
PEI 5 ○ 760 l m²
relief matt
color **dune**
beige | beige



DAR66856
PEI 5 ○ 760 l m²
relief matt
color **cement**
grau | grey



DAR66857
PEI 4 ○ 760 l m²
relief matt
color **ash**
dunkelgrau | dark grey

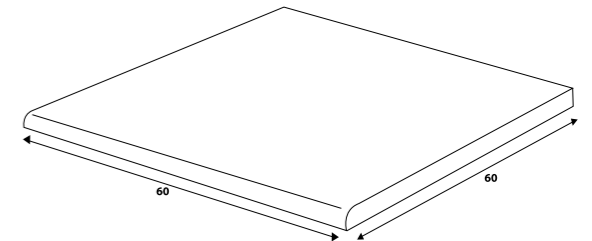

DCH66856 color **cement** | grau | grey
DCH66857 color **ash** | dunkelgrau | dark grey
DCH66858 color **dune** | beige | beige
PEI 4-5 ○ 780 l St
relief matt

Produkt product	60x60	598x598x20	EN	Stim ²	m ²	kg	kg/m ²	brutto kg			
Bodenfliese floor tile	60x60	598x598x20	EN 14411 - G Bla	2	2,8	0,72	30	21,6	32,5	45,1	999
Stufe step tile	60x60	598x598x20	EN 14411 - G Bla	2	-	-	-	-	32,5	-	-



WAKV6730
○ 680 l m²
matt

WAKV6830
○ 680 l m²
glossy

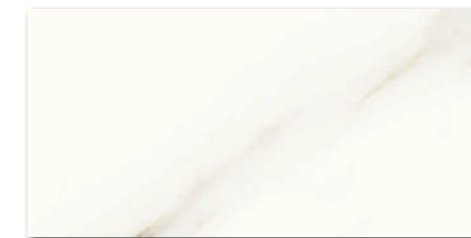

WAKVK730
○ 500 l m²
matt

WAKVK830
○ 500 l m²
glossy



WARVK730
○ 500 l m²
relief matt

WARVK830
○ 500 l m²
relief glossy



WDM05730
○ 250 l Netz
matt
weiß | white

(SHEET)
WDM05830
○ 250 l Netz
glossy



WDM05731
○ 250 l Netz
matt
weiß-gold | white-gold

(SHEET)
WDM05831
○ 250 l Netz
glossy



Produkt product	cm	mm	EN	St/m ²	kg/m ²	kg	kg	kg	kg	kg	
Wandfliese wall tile	40x120	398x1198x10	EN 14411 - L BIII	3	2,1	1,44	21	30,24	29,0	20,1	633
Wandfliese wall tile	30x60	298x598x8	EN 14411 - L BIII	8	5,56	1,44	40	57,6	21,3	14,8	876
Mosaik set 30x30 cm mosaic sheet 30x30	5x5	48x48x8	STD No. 030 - 059826	4	11	0,36	-	-	5,2	14,8	-

Um das optimale Effekt zu erreichen, empfehlen wir die Verlegung in einer Richtung. | For optimal effect, the laying of individual tiles in one direction is recommended.



Die Fliesen der Serie zeichnen sich durch ein breites Farbspiel V4 aus. | All products of the entire batch show big deviations in shade difference V4.

Wir empfehlen, einzelne Fliesen aus mehreren Paketen herauszunehmen und den gesamten Bodenbelag nach der Inspirationsfotodokumentation in den Katalogen RAKO, eventuell den Webseiten www.rako.eu, zu komponieren. Wünschenswert ist die Kombination aller Fliesendesigns einschließlich ihrer Drehung um 90° oder 180°, sodass ausgewogene Optik der verlegten Fläche erzielt wird.

Before laying the tiles, we suggest you select from several cartons and arrange them as illustrated in the inspiration photo documentation in RAKO catalogues or website www.rako.eu, and mix the tiles to achieve the required result including turning them by 90° or 180°.

Produkt product	cm	mm	EN	St/m ²	St/m ²	St/m ²	St/m ²	St/m ²	St/m ²	kg/m ²	St/m ²
Bodenfliese floor tile*	60-60	598-598-10	EN 14411 - G Bla	3	2,8	1,08	32	34,56	23,7	21,9	782
Bodenfliese floor tile**	60-60	598-598-9	EN 14411 - G Bla	4	2,8	1,44	32	46,08	29,1	20,2	955
Mosaik set 30x30 cm mosaic sheet 30x30 cm*	5x5	48-48-10	EN 14411 - G Bla	3	11	0,27	-	-	5,9	-	-
Mosaik 30x30 cm mosaic sheet 30x30 cm**	5x5	48-48-9	EN 14411 - G Bla	3	11	0,27	-	-	5,2	-	-
Stufe step tile*	60-60	598-597-10	EN 14411 - G Bla	6	5,6	1,08	-	-	23,7	-	-
Stufe step tile**	60-60	598-597-9	EN 14411 - G Bla	3	2,8	1,08	-	-	21,9	-	-
Stufenformteil special step tile*	60-53	598-530-10	STO No. 030 - 059824	2	-	-	-	-	-	-	-
Stufenformteil special step tile**	60-53	598-530-9	STO No. 030 - 059824	2	-	-	-	-	-	-	-
Sockel skirting plinth*	60-9,5	598-95-10	EN 14411 - G Bla	13	17,5	0,74	-	-	16,2	-	-
Sockel skirting plinth**	60-7,2	598-72-9	EN 14411 - G Bla	14	23,1	0,60	-	-	11,5	-	-



60x60
V4

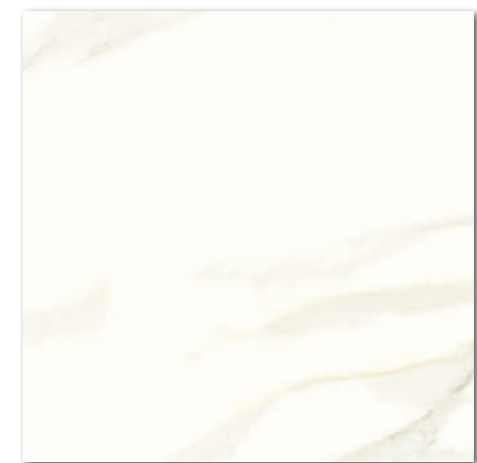

DAK63830*
DAK62830**
PEI 5 ○ 610 | m²
matt | R9/A

DAL63830*
DAL62830**
PEI 4 ○ 840 | m²
full lappato



5x5 | 30x30

V4

DDM06830*
DDM05830**
PEI 5 ○ 300 | Netz
matt | R10/B

DDL06830*
DDL05830**
PEI 4 ○ 440 | Netz
full lappato

(SHEET)

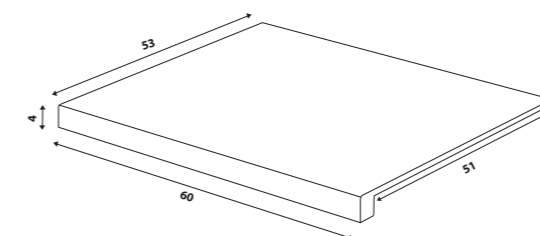

DCF65830*
DCF64830**
PEI 5 ○ 900 | St
matt | R9/A

DCG65830*
DCG64830**
PEI 4 ○ 900 | St
full lappato

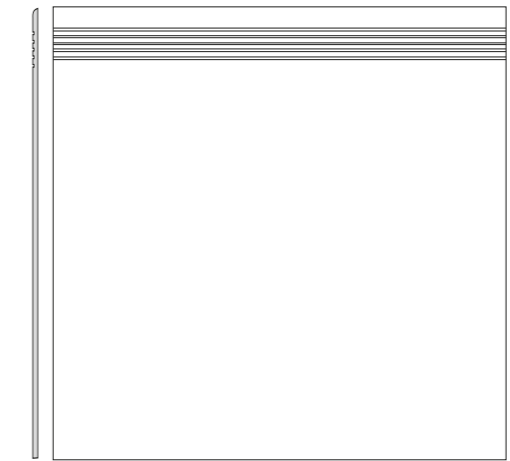

60x53
60x60
V4

DCP63830*
DCP62830**
PEI 5 ○ 370 | St
matt | R9/A



60x9,5*
60x7,2**

DSAS4830*
DSAS3830**
○ 180 | St
matt
weiß | white

DSKS4830*
DSKS3830**
○ 270 | St
full lappato

* Verfügbar solange der Vorrat reicht | Available while stocks last

** Neues Produkt in 9 mm Stärke im Laufe des Jahres 2025 verfügbar | New product in 9 mm thickness available during 2025



60x60
R9
V3
R

30x60
R9
V3
R

30x60
R10/A
V3
R

5x5 | 30x30
R10/B
V3
R

30x60
60x9,5
R



DAK63660
PEI 5 ○ 560 | m²
matt



DAKSE660
PEI 5 ○ 540 | m²
matt



DDPSE660 (SHEET)
PEI 5 ○ 530 | Netz
relief matt



DDM06660 (SHEET)
PEI 5 ○ 300 | Netz
relief matt
hellgrau | light grey



DAK63661
PEI 5 ○ 560 | m²
matt



DAKSE661
PEI 5 ○ 540 | m²
matt



DDPSE661 (SHEET)
PEI 5 ○ 530 | Netz
relief matt



DDM06661 (SHEET)
PEI 5 ○ 300 | Netz
relief matt
grau | grey

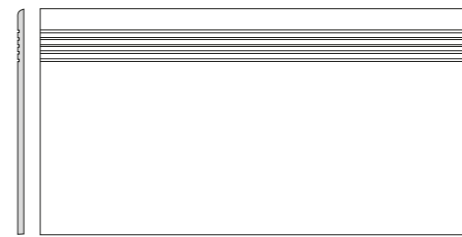

DCPSE660 hellgrau | light grey
DCPSE661 grau | grey
DCPSE662 grau-beige | grey-beige
PEI 5 ○ 270 | St
matt | R9 | V3



DAK63662
PEI 5 ○ 560 | m²
matt



DAKSE662
PEI 5 ○ 540 | m²
matt



DDPSE662 (SHEET)
PEI 5 ○ 530 | Netz
relief matt



DDM06662 (SHEET)
PEI 5 ○ 300 | Netz
relief matt
grau-beige | grey-beige



DSAS4660 hellgrau | light grey
DSAS4661 grau | grey
DSAS4662 grau-beige | grey-beige
○ 180 | St
matt

Produkt product	cm	mm	EN	St/m ²	kg/m ²	St/m ²	kg/m ²	St/m ²	kg/m ²	St/m ²	kg/m ²
Bodenfliese floor tile	60x60	598x598x10	EN 14411 - G Bla	3	2,8	1,08	32	34,56	23,7	21,9	782
Bodenfliese floor tile	30x60	298x598x10	EN 14411 - G Bla	6	5,6	1,08	40	43,20	23,7	21,9	971
Dekor decor	30x60	298x598x10	EN 14411 - G Bla	4	5,6	0,72	-	-	15,8	21,9	-
Mosaik set 30x30 cm mosaic sheet 30x30 cm	5x5	48x48x10	EN 14411 - G Bla	3	11	0,27	-	-	5,9	21,9	-
Stufe step tile	30x60	298x598x10	EN 14411 - G Bla	6	5,6	1,08	-	-	23,7	21,9	-
Sockel skirting plinth	60x9,5	598x95x10	EN 14411 - G Bla	13	17,5	0,74	-	-	16,2	21,9	-

Empfohlene Formatkombinationen siehe Seite 522-523. | Recommended combinations of modular sizes see pages 522-523.



DAR34692
PEI 5 \odot 430 | m²
relief matt



DAR34693
PEI 5 \odot 430 | m²
relief matt



DAR34694
PEI 3 \odot 430 | m²
relief matt



DDP34692 (SHEET)
PEI 5 \odot 400 | Netz
relief matt



DDP34693 (SHEET)
PEI 5 \odot 400 | Netz
relief matt



DDP34694 (SHEET)
PEI 3 \odot 400 | Netz
relief matt



DDM05692 (SHEET)
PEI 5 \odot 300 | Netz
relief matt
weiß | white



DDM05693 (SHEET)
PEI 5 \odot 300 | Netz
relief matt
beige | beige

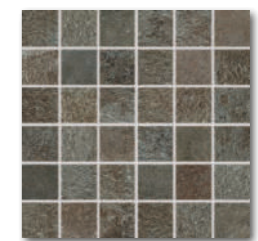

DDM05694 (SHEET)
PEI 3 \odot 300 | Netz
relief matt
braun-schwarz | brown-black

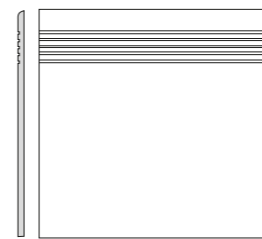

DCP34692 weiß | white
DCP34693 beige | beige
DCP34694 braun-schwarz | brown-black
PEI 3-5 \odot 150 | St
relief matt

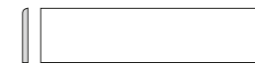

DSAJ8692 weiß | white
DSAJ8693 beige | beige
DSAJ8694 braun-schwarz | brown-black
 \odot 110 | St
relief matt



30x30
R9/A
v4



30x30
R9/A
v4



5x5 | 30x30
R10/A
v4



30x30
R9/A
v4

30x7,2

Produkt | product

	cm	mm	EN	St/m ²	kg/m ²	kg	kg	kg	kg	kg	kg
Bodenfliese floor tile	30x30	298x298x8	EN 14411 - G Bla	13	11	1,18	48	56,64	20,5	17,4	1 011
Dekor (set) decor (set)	30x30	298x298x8	EN 14411 - G Bla	4	11	0,36	-	-	6,3	17,4	-
Mosaik set 30x30 cm mosaic sheet 30x30 cm	5x5	48x48x8	EN 14411 - G Bla	3/4	11	0,27/0,36	-	-	4,7/6,2	17,4	-
Stufe step tile	30x30	298x298x8	EN 14411 - G Bla	13	11	1,18	52	-	20,5	17,4	-
Sockel skirting plinth	30x7,2	298x72x8	EN 14411 - G Bla	30	46,3	0,65	-	-	11,3	17,4	-

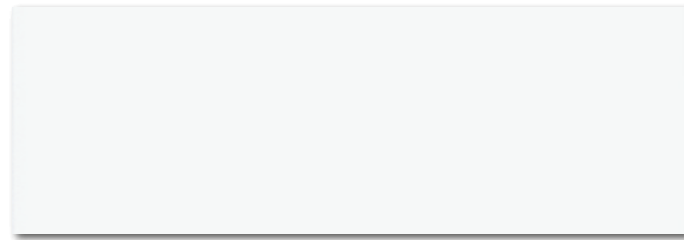

WAKV5104*
WAKVN104**
○ 660 | m²
matt | V1

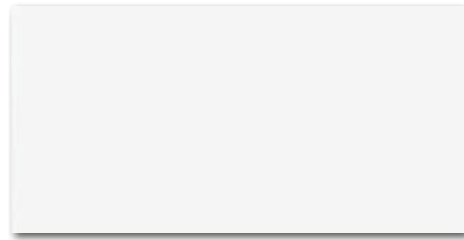

WAKV5000*
WAKVN000**
○ 660 | m²
glossy | V1

WAKVK104
○ 480 | m²
matt | V1

WAKVK000
○ 480 | m²
glossy | V1

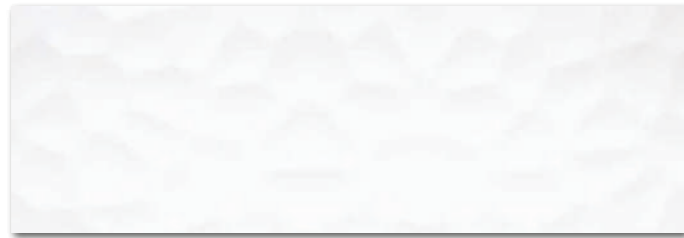

WR2V5104*
WR2VN104**
○ 750 | m²
matt | V2
weiß | white

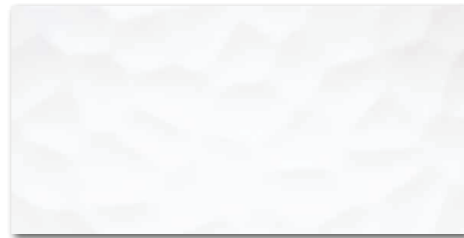

WR2V5000*
WR2VN000**
○ 750 | m²
glossy | V2

WR2VK104
○ 500 | m²
matt | V2

WR2VK000
○ 500 | m²
glossy | V2

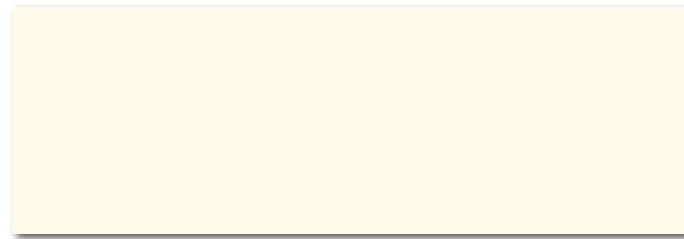

WAKV5107
○ 710 | m²
matt | V1

hellbeige | light beige

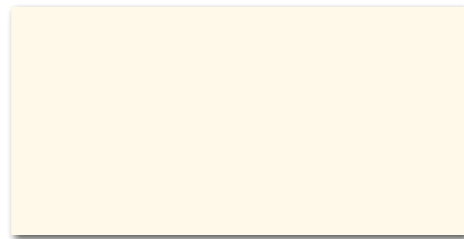

WAKV5007
○ 710 | m²
glossy | V1

WAKVK107
○ 500 | m²
matt | V1

WAKVK007
○ 500 | m²
glossy | V1

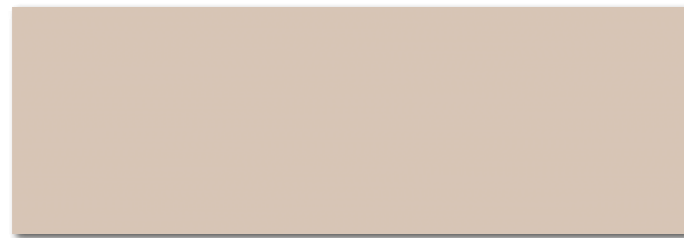

WAKV5108
○ 710 | m²
matt | V1

beige | beige

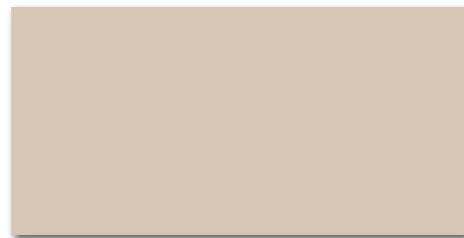

WAKV5008
○ 710 | m²
glossy | V1

WAKVK108
○ 500 | m²
matt | V1

WAKVK008
○ 500 | m²
glossy | V1

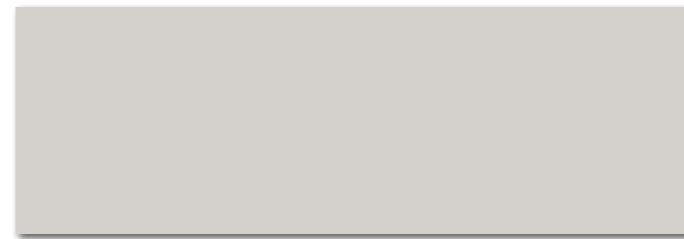

WAKV5112
○ 710 | m²
matt

hellgrau | light grey

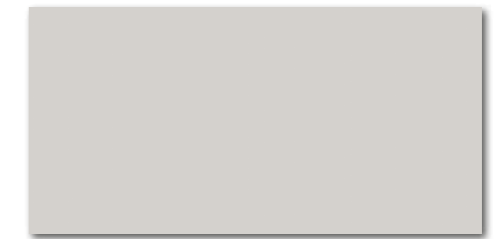

WAKV5012
○ 710 | m²
glossy

WAKVK112
○ 500 | m²
matt

WAKVK012
○ 500 | m²
glossy

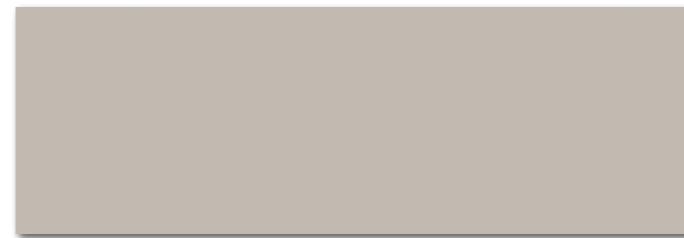

WAKV5110
○ 710 | m²
matt

grau | grey

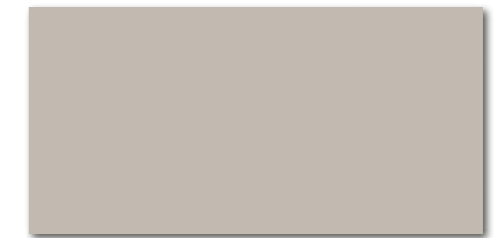

WAKV5010
○ 710 | m²
glossy

WAKVK110
○ 500 | m²
matt

WAKVK010
○ 500 | m²
glossy



* Verfügbar solange der Vorrat reicht | Available while stocks last

** Neues Produkt in 8 mm Stärke im Laufe des Jahres 2025 verfügbar | New product in 8 mm thickness available during 2025

Produkt product	30x90	298x898x10	EN	4	5	8	30	40	20,0	14,8	625
Wandfliese wall tile*	30x90	298x898x10	EN 14411 - L BIII	4	3,7	1,08	30	32,40	20,0	14,8	625
Wandfliese wall tile**	30x90	298x898x8	EN 14411 - L BIII	5	3,7	1,35	30	40,50	20,0	14,8	625
Wandfliese wall tile	30x60	298x598x8	EN 14411 - L BIII	8	5,56	1,44	40	57,60	21,3	14,8	876



30x60
20x60
v1

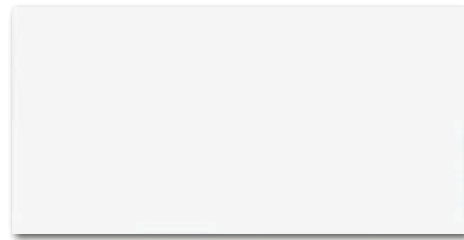

WAAVK104
○ 430 l m²
matt
weiß | white

WAAVK000
○ 430 l m²
glossy

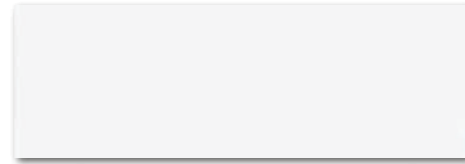

WAAVE104
○ 430 l m²
matt

WAAVE000
○ 430 l m²
glossy

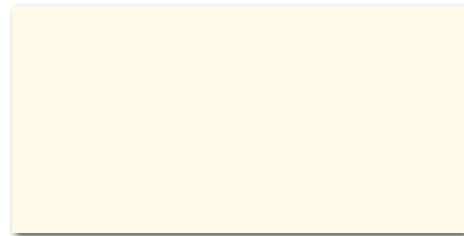

WAAVK107
○ 480 l m²
matt
hellbeige | light beige

WAAVK007
○ 480 l m²
glossy

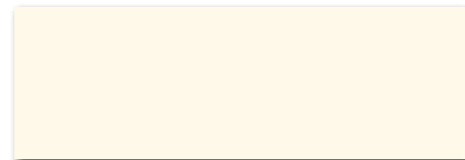

WAAVE107
○ 480 l m²
matt

WAAVE007
○ 480 l m²
glossy

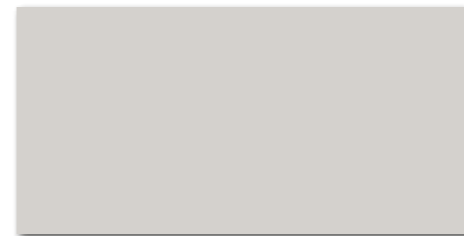

WAAVK112
○ 480 l m²
matt
hellgrau | light grey

WAAVK012
○ 480 l m²
glossy

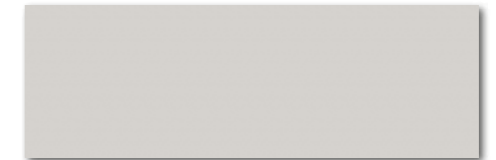

WAAVE112
○ 480 l m²
matt

WAAVE012
○ 480 l m²
glossy



WAAVK108
○ 480 l m²
matt
beige | beige

WAAVK008
○ 480 l m²
glossy



WAAVE108
○ 480 l m²
matt

WAAVE008
○ 480 l m²
glossy



WAAVK110
○ 480 l m²
matt
grau | grey

WAAVK010
○ 480 l m²
glossy



WAAVE110
○ 480 l m²
matt

WAAVE010
○ 480 l m²
glossy

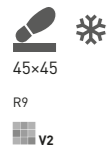

45x45
R9
v2

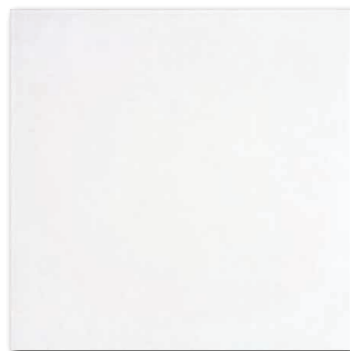

DAA4H599
PEI 4 ○ 510 l m²
matt
weiß | white



DAA4H600
PEI 4 ○ 510 l m²
matt
beige | beige



DAA4H601
PEI 3 ○ 510 l m²
matt
braun | brown



DAA4H602
PEI 4 ○ 510 l m²
matt
grau | grey



DAA4H603
PEI 3 ○ 510 l m²
matt
schwarz | black



30x60
20x60
v1



45x45
R9
v2

Produkt | product



Produkt product	cm	mm	EN	PEI	St/m ²	kg/m ²	mm	kg/m ³	kg	kg	
Wandfliese wall tile	30x60	298x598x8	EN 14411 - L BIII	8	5,56	1,44	40	57,60	21,3	14,8	876
Wandfliese wall tile	20x60	198x598x10	EN 14411 - L BIII	9	8,3	1,08	42	45,36	20	18,5	865
Bodenfliese floor tile	45x45	448x448x8	EN 14411 - G BIIa	6	5	1,21	34	41,14	21,1	17,4	741



20x40
v1

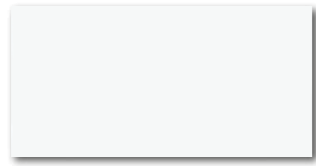

WAAMB104
390 | m²
matt
WAAMB000
390 | m²
glossy

weiß | white



WAAMB107
440 | m²
matt



WAAMB007
440 | m²
glossy

WAAMB108
440 | m²
matt

WAAMB008
440 | m²
glossy



WAAMB109
500 | m²
matt

WAAMB009
500 | m²
glossy



WAAMB112
440 | m²
matt

WAAMB012
440 | m²
glossy



WAAMB110
440 | m²
matt

WAAMB010
440 | m²
glossy



WAAMB111
500 | m²
matt

WAAMB011
500 | m²
glossy

20x40



WIFMB007
220 | St
glossy



WIFMB008
220 | St
glossy



WIFMB009
220 | St
glossy



WIFMB012
220 | St
glossy



WIFMB010
220 | St
glossy



WIFMB011
220 | St
glossy

20x40



WITMB029
Interia
350 | St
matt



WITMB021
Monopoli
220 | St
matt



WITMB030
Interia
350 | St
matt



WITMB022
Monopoli
220 | St
matt

40x4,3
40x4,5



WLAMH004
Interia
220 | St
matt



WLAMH010
Monopoli
170 | St
glossy

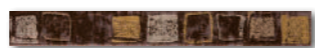

WLAMH011
Monopoli
170 | St
glossy

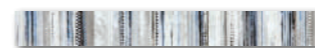

WLAMH008
Interia
220 | St
matt



WLAMH012
Monopoli
170 | St
glossy



WLAMH013
Monopoli
170 | St
glossy

20x3

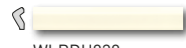

WLRDH030
140 | St
matt
hellbeige | light beige

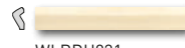

WLRDH031
140 | St
matt
beige | beige

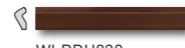

WLRDH032
140 | St
matt
braun | brown

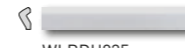

WLRDH035
140 | St
matt
hellgrau | light grey

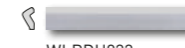

WLRDH033
140 | St
matt
grau | grey

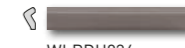

WLRDH034
140 | St
matt
dunkelgrau | dark grey

20x6



WARDT104
150 | St
matt
weiß | white



WARDT107
150 | St
matt
hellbeige | light beige



WARDT108
150 | St
matt
beige | beige



WARDT109
150 | St
matt
braun | brown



WARDT112
150 | St
matt
hellgrau | light grey



WARDT110
150 | St
matt
grau | grey



WARDT111
150 | St
matt
dunkelgrau | dark grey



WARDT001
150 | St
glossy
orange | orange



WARDT002
150 | St
glossy
rot | red



20x40
v1

20x40

20x40

40x4,3
40x4,5

20x3

20x6



25x33
v1

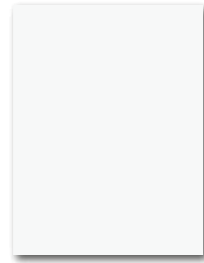

WAAKB104
360 | m²
matt

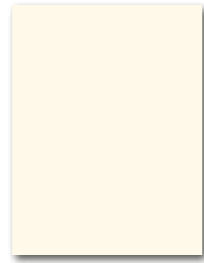

WAAKB000
360 | m²
glossy

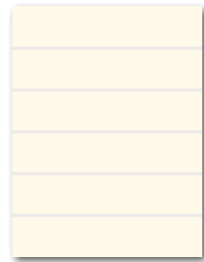

WAAKB107
430 | m²
matt

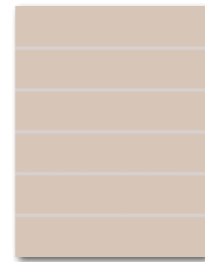

WAAKB007
430 | m²
glossy



WAAKB108
430 | m²
matt

WAAKB008
430 | m²
glossy



WAAKB109
490 | m²
matt

WAAKB009
490 | m²
glossy



WAAKB112
430 | m²
matt



WAAKB012
430 | m²
glossy

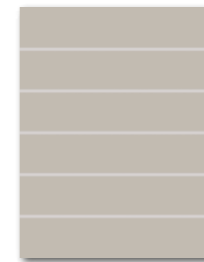

WAAKB110
430 | m²
matt

WAAKB010
430 | m²
glossy



WAAKB111
490 | m²
matt

WAAKB011
490 | m²
glossy



25x33
v1

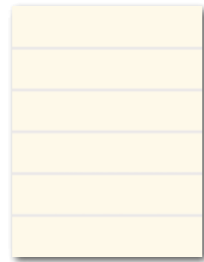

WIFKB107
Akcent
220 | St
matt

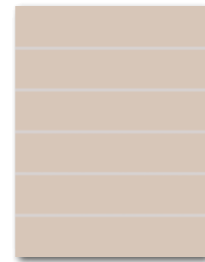

WIFKB108
Akcent
220 | St
matt



WIFKB109
Akcent
220 | St
matt

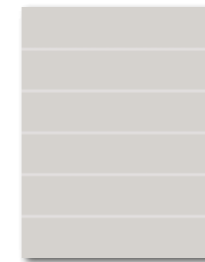

WIFKB112
Akcent
220 | St
matt

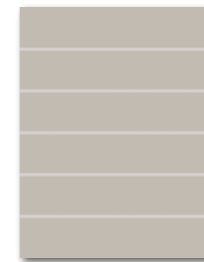

WIFKB110
Akcent
220 | St
matt



WIFKB111
Akcent
220 | St
matt

25x10
25x4,5
25x1,5

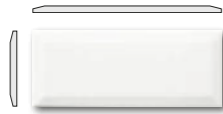

WARGT104
150 | St
matt
weiß | white

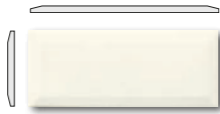

WARGT107
150 | St
matt
hellbeige | light beige



WARGT108
150 | St
matt

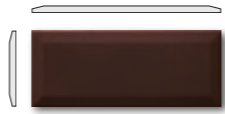

WARGT109
150 | St
matt



WARGT112
150 | St
matt
hellgrau | light grey



WARGT110
150 | St
matt



WARGT111
150 | St
matt
dunkelgrau | dark grey

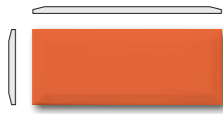

WARGT001
150 | St
glossy
orange | orange



WLAH5010
Monopoli
160 | St
glossy



WLAH5011
Monopoli
160 | St
glossy



VLAG8001
Akcent
140 | St
glossy



WARGT002
150 | St
glossy
rot | red



WLAH5012
Monopoli
160 | St
glossy



WLAH5013
Monopoli
160 | St
glossy



VLAG8002
Akcent
140 | St
glossy

25x10
25x4,5
25x1,5

RAKO Home



30x30
R9
v2

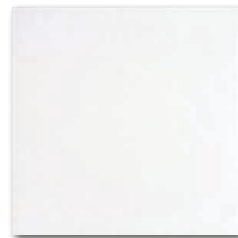

DAA34599
PEI 4 390 | m²
matt
weiß | white



DAA34600
PEI 4 390 | m²
matt
beige | beige



DAA34601
PEI 3 390 | m²
matt
braun | brown



DAA34602
PEI 4 390 | m²
matt
grau | grey



DAA34603
PEI 3 390 | m²
matt
schwarz | black



30x30
R9
v2

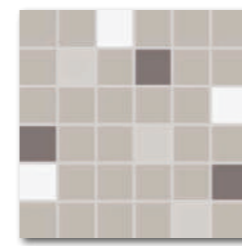

WDM05010 (SHEET)
 250 | Netz
 glossy
 grau | grey

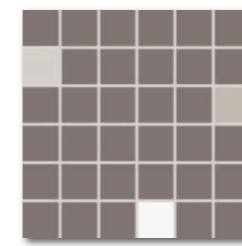

WDM05011 (SHEET)
 250 | Netz
 glossy
 dunkelgrau | dark grey

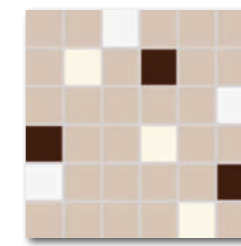

WDM05008 (SHEET)
 250 | Netz
 glossy
 beige | beige

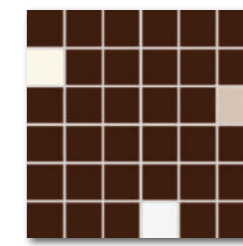

WDM05009 (SHEET)
 250 | Netz
 glossy
 braun | brown



5x5 | 30x30

>

v4

R



45x8,5

- DSAPS599 weiß | white
- DSAPS600 beige | beige
- DSAPS601 braun | brown
- DSAPS602 grau | grey
- DSAPS603 dunkelgrau | dark grey
- 160 | St
- matt



30x7,2

- DSAJ8599 weiß | white
- DSAJ8600 beige | beige
- DSAJ8601 braun | brown
- DSAJ8602 grau | grey
- DSAJ8603 dunkelgrau | dark grey
- 110 | St
- matt



Produkt product	cm	mm	EN	cm	St/m²	mm	cm	mm	kg	kg/m²	brutto kg
Wandfliese wall tile	20x40	198x398x7	EN 14411 - L BIII	20	12,5	1,6	48	76,80	20,6	12,9	1 016
Dekor decor	20x40	198x398x7	EN 14411 - L BIII	4	12,5	0,32	-	-	4,1	12,9	-
Bordüre listel	40x4,3	398x43x7	EN 14411 - L BIII	12	58	0,2	-	-	1,4	12,9	-
Bordüre listel	40x4,5	398x45x7	EN 14411 - L BIII	12	58	0,2	-	-	1,4	12,9	-
Bordüre relief listel	20x3	198x30	STO No. 030 - 060753	18	167	0,11	-	-	1,7	15,8	-
Dekor decor	20x6	198x60x7	EN 14411 - L BIII	18	83,3	0,22	-	-	2,8	12,9	-
Wandfliese wall tile	25x33	250x330x7	EN 14411 - L BIII	18	12	1,5	54	81,00	18,6	12,4	1 030
Dekor decor	25x33	250x330x7	EN 14411 - L BIII	4	12	0,33	50	16,50	4,4	12,4	-
Dekor decor	25x10	250x100x7	EN 14411 - L BIII	20	40	0,5	-	-	6,3	12,6	-
Bordüre listel	25x4,5	250x45x7	EN 14411 - L BIII	14	88,9	0,16	-	-	2,2	12,9	-
Bordüre (VLAG*) listel (VLAG*)	25x1,5	250x15x6	STO No. 030 - 059826	30	-	-	-	-	2,8	-	-
Bodenfliese floor tile	30x30	298x298x8	EN 14411 - G BIIa	13	11	1,18	48	56,64	20,5	17,4	1 011
Mosaik set 30x30 cm mosaic sheet 30x30 cm	5x5	48x48x7	STO No. 030 - 059826	3/4	11	0,27/0,36	-	-	3,5/4,8	12,9	-
Sockel skirting plinth	45x8,5	448x85x8	EN 14411 - G BIIa	25	26,1	0,96	-	-	16,7	17,4	-
Sockel skirting plinth	30x7,2	298x72x8	EN 14411 - G BIIa	30	46,3	0,65	-	-	11,3	17,4	-

60x60
45x45
15x60
15x45
R9
V4
RE

20x40

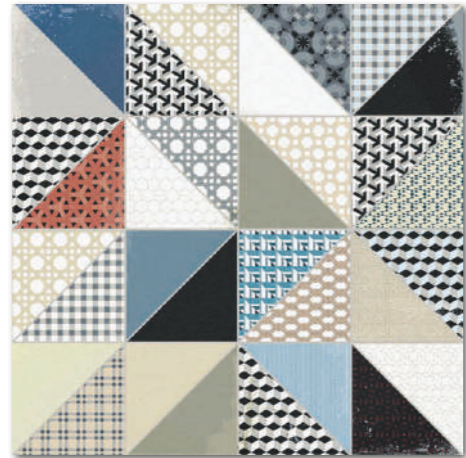

DAK63659*
DAK62659**
PEI 4 ○ 530 | St
matt
mehrfarbig | multicoloured



DAK4H659
PEI 4 ○ 460 | St
matt



DDPSU659*
DDPSX659**
PEI 4 ○ 360 | St
matt



DDPP2659
PEI 4 ○ 300 | St
matt



WATMB060
○ 400 | m²
matt | V2
weiß | white

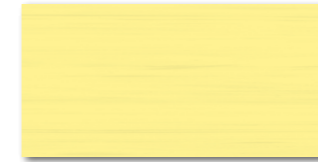

WATMB063
○ 400 | m²
matt | V2

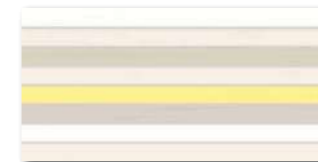

WILMB063
○ 300 | Netz
matt | >8



WLRMG063
○ 220 | St
matt
gelb | yellow

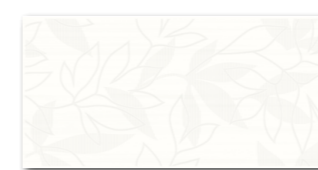

WITMB060
○ 300 | St
matt



WLRMG060
○ 220 | St
matt



WITMB047
○ 300 | St
matt
weiß | white



WATMB061
○ 400 | m²
matt | V2
grau | grey



WATMB064
○ 400 | m²
matt | V2

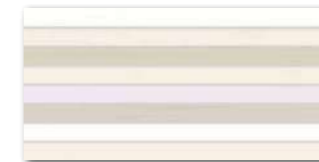

WILMB064
○ 300 | Netz
matt | >8



WLRMG064
○ 220 | St
matt
lila | violet



WITMB061
○ 300 | St
matt



WLRMG061
○ 220 | St
matt
grau | grey



WATMB062
○ 400 | m²
matt | V2
beige | beige

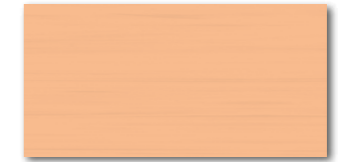

WATMB065
○ 400 | m²
matt | V2

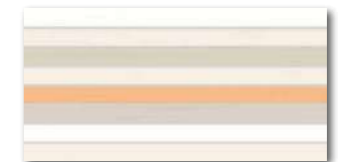

WILMB065
○ 300 | Netz
matt | >8



WLRMG065
○ 220 | St
matt
orange | orange

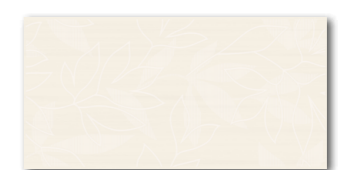

WITMB062
○ 300 | St
matt



WLRMG062
○ 220 | St
matt
beige | beige



WDM05060 (SHEET)
○ 250 | Netz
matt | >8 | V3 | RE
weiß | white

* Verfügbar solange der Vorrat reicht | Available while stocks last

** Neues Produkt in 9 mm Stärke im Laufe des Jahres 2025 verfügbar | New product in 9 mm thickness available during 2025

Die Serie Deco zeigt die individuellen Designmöglichkeiten auf in jeder Verpackung. Die Variationsmöglichkeiten reichen von drei DAK++659 bis zu 24 mögliche Variationen bei DDP++659. The products of Deco serie are deliberately mixed in packing to include a random selection of designs. DAK++659 has 3 designs as shown, and DDP++659 has up to 24 possibilities.

Produkt product	cm	mm	EN	St/m ²	kg/m ²	kg	kg	kg	kg	kg	kg
Bodenfliese floor tile*	60x60	598x598x10	EN 14411 - G Bla	3	2,8	1,08	-	-	23,7	21,9	-
Bodenfliese floor tile**	60x60	598x598x9	EN 14411 - G Bla	4	2,8	1,44	32	46,08	29,1	20,2	955
Bordüre floor tile listel*	15x60	148x598x10	EN 14411 - G Bla	10	11,1	0,90	-	-	19,7	21,9	-
Bordüre floor tile listel**	15x60	148x598x9	EN 14411 - G Bla	11	11,1	0,99	-	-	19,0	-	-
Bodenfliese floor tile	45x45	445x445x8	EN 14411 - G Bla	6	5	1,21	-	-	21,1	17,4	741
Bordüre floor tile listel	15x45	147x445x8	EN 14411 - G Bla	18	14,8	1,21	-	-	21,1	17,4	-

Wir empfehlen die Kombination mit den Fliesen der Serie Concept. | To combine with Concept floor tiles is recommended.

Produkt product	cm	mm	EN	St/m ²	kg/m ²	kg	kg	kg	kg	kg	kg
Wandfliese wall tile	20x40	198x398x7	EN 14411 - L BlII	20	12,5	1,60	48	76,80	20,6	12,9	1 016
Dekor decor	20x40	198x398x7	EN 14411 - L BlIII	4	12,5	0,32	-	-	4,1	12,9	-
Bordüre relief listel	40x2	398x20x7	STO No. 030 - 060753	12	125	0,10	-	-	1,2	12,9	-
Mosaik set 30x30 cm mosaic sheet 30x30 cm	5x5	48x48x7	STO No. 030 - 059826	3/4	11	0,27/0,36	-	-	3,5/4,8	12,9	-

20x40
5x5 | 30x30



DAR4G706
PEI 5 ○ 510 l m²
relief matt
weiß | white



DAR4G707
PEI 4 ○ 510 l m²
relief matt
beige | beige



DAR4G708
PEI 4 ○ 510 l m²
relief matt
rot-braun | red-brown



DAR4G709
PEI 4 ○ 510 l m²
relief matt
braun | brown



DDM05706 (SHEET)
PEI 5 ○ 300 | Netz
relief matt
weiß | white

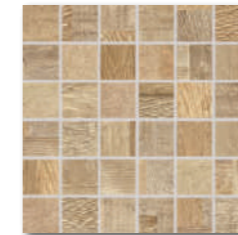

DDM05707 (SHEET)
PEI 4 ○ 300 | Netz
relief matt
beige | beige



DDM05708 (SHEET)
PEI 4 ○ 300 | Netz
relief matt
rot-braun | red-brown



DDM05709 (SHEET)
PEI 4 ○ 300 | Netz
relief matt
braun | brown



Produkt | product

Bodenfliese floor tile	45x45	448x448x8	EN 14411 - G Bla	6	5	1,21	34	41,14	21,1	17,4	741
Mosaik set 30x30 cm mosaic sheet 30x30 cm	5x5	48x48x8	EN 14411 - G Bla	3/4	11	0,27/0,36	-	-	4,7/6,2	17,4	-



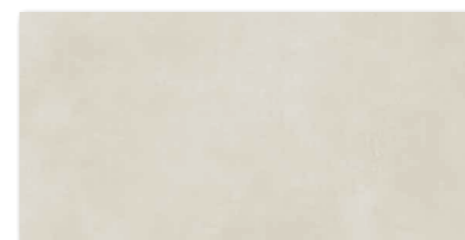

WADV820
 ○ 480 l m²
 relief matt | **V3**

WARVK820
 ○ 500 l m²
 relief matt | **V3**

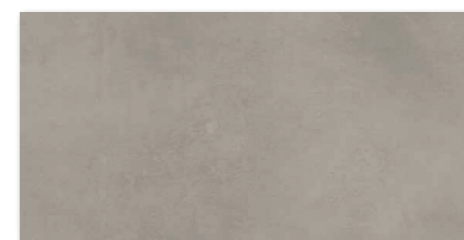

WADV821
 ○ 480 l m²
 relief matt | **V3**

WARVK821
 ○ 500 l m²
 relief matt | **V3**



30x60



WADV826
 ○ 480 l m²
 relief matt|glossy | **V4**



WARVK833
 ○ 500 l m²
 relief matt|glossy | **V4**



WARVK831
 ○ 500 l m²
 relief matt|glossy | **V4**



WDM05820 (SHEET)
 ○ 250 l Netz
 relief matt
 elfenbein | ivory



WDM05821 (SHEET)
 ○ 250 l Netz
 relief matt
 braun-grau | brown-grey

5x5 | 30x30



Produkt | product



Produkt product	30x60	298x598x8	EN 14411 - L BIII	8	5,56	1,44	40	57,60	21,3	14,8	876
Wandfliese wall tile	30x60	298x598x8	EN 14411 - L BIII	8	5,56	1,44	40	57,60	21,3	14,8	876
Mosaik set 30x30 cm mosaic sheet 30x30 cm	5x5	48x48x8	STO No. 030 - 059826	4	11	0,36	-	-	5,2	14,8	-

Das Produkt zeigt die individuellen Designmöglichkeiten auf in jeder Verpackung. | This product is deliberately mixed in packing to include a random selection of designs.



30x60



WADV822
○ 480 l m²
relief matt | **V3**

WARV822
○ 500 l m²
relief matt | **V3**

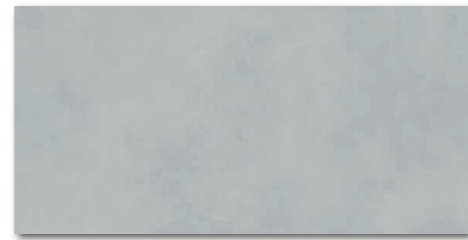

WADV823
○ 480 l m²
relief matt | **V3**

WARV823
○ 500 l m²
relief matt | **V3**



WADV824
○ 480 l m²
relief matt | **V3**

WARV824
○ 500 l m²
relief matt | **V3**



WADV825
○ 480 l m²
relief matt | **V3**

WARV825
○ 500 l m²
relief matt | **V3**



WADV827
○ 480 l m²
relief matt|glossy | **V4**



WADV828
○ 480 l m²
relief matt|glossy | **V4**

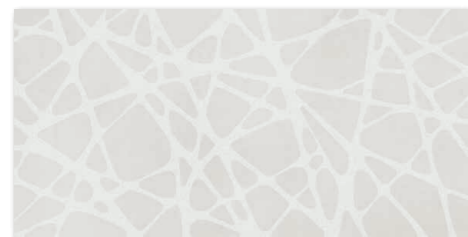

WARV834
○ 500 l m²
relief matt|glossy | **V4**

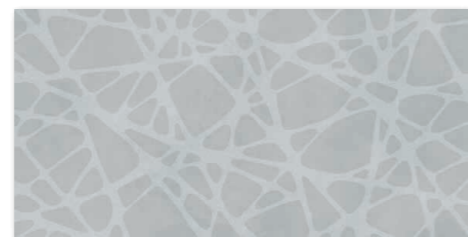

WARV835
○ 500 l m²
relief matt|glossy | **V4**



WARV832
○ 500 l m²
relief matt|glossy | **V4**



5x5 | 30x30

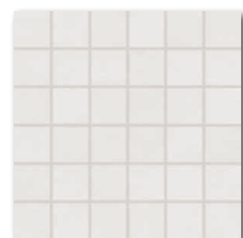

WDM05822 (SHEET)
○ 250 l Netz
relief matt
weiß | white



WDM05823 (SHEET)
○ 250 l Netz
relief matt
hellgrau | light grey



WDM05824 (SHEET)
○ 250 l Netz
relief matt
dunkelgrau | dark grey



WDM05825 (SHEET)
○ 250 l Netz
relief matt
schwarz | black

5x5 | 30x30



Produkt | product



Produkt product	H (cm)	W (cm)	EN	Blätter	Stk/m ²	mm	m ²	kg	kg/m ²	kg
Wandfliese wall tile	30-60	298-598-8	EN 14411 - L BIII	8	5,56	1,44	40	57,60	21,3	14,8
Mosaik set 30x30 cm mosaic sheet 30x30 cm	5x5	48x48-8	STD No. 030 - 059826	4	11	0,36	-	-	5,2	14,8

Das Produkt zeigt die individuellen Designmöglichkeiten auf in jeder Verpackung. | This product is deliberately mixed in packing to include a random selection of designs.

20x40



WADMB719
○ 440 | m²
matt | **V2**

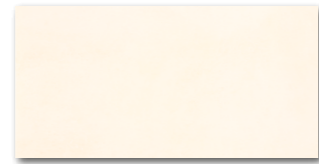

WADMB720
○ 440 | m²
matt | **V2**

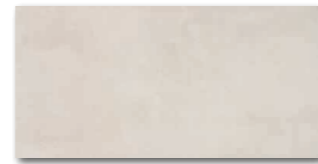

WADMB721
○ 440 | m²
matt | **V2**

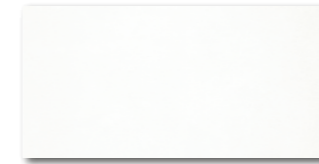

WADMB722
○ 440 | m²
matt | **V2**

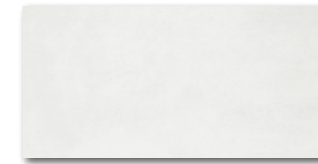

WADMB723
○ 440 | m²
matt | **V2**

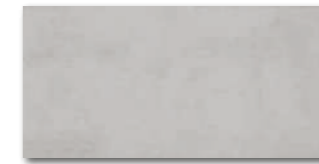

WADMB724
○ 440 | m²
matt | **V2**



WADMB220
○ 440 | m²
matt | **V4**
elfenbein | ivory



WADMB223
○ 440 | m²
matt | **V4**
hellgrau | light grey

40x2



WLRMG719
○ 240 | St
relief matt



WLRMG720
○ 240 | St
relief matt



WLRMG721
○ 240 | St
relief matt



WLRMG722
○ 240 | St
relief matt



WLRMG723
○ 240 | St
relief matt



WLRMG724
○ 240 | St
relief matt

5x5 | 30x30

V2

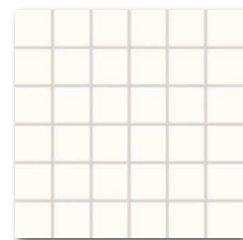

WDM05719 (SHEET)
○ 250 | Netz
matt
weiß-beige | white-beige

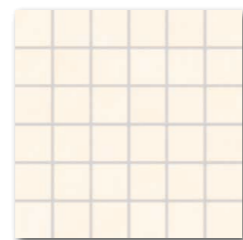

WDM05720 (SHEET)
○ 250 | Netz
matt
elfenbein | ivory

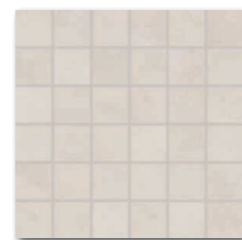

WDM05721 (SHEET)
○ 250 | Netz
matt
braun-grau | brown-grey

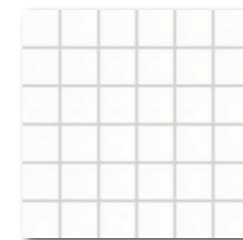

WDM05722 (SHEET)
○ 250 | Netz
matt
weiß-grau | white-grey



WDM05723 (SHEET)
○ 250 | Netz
matt
hellgrau | light grey

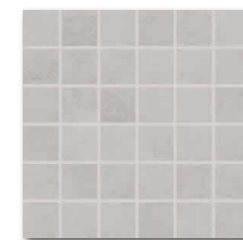

WDM05724 (SHEET)
○ 250 | Netz
matt
dunkelgrau | dark grey

Produkt | product



EN



St/m²



kg/m²



Produkt product	20x40	198x398x7	EN 14411 - L BIII	20	12,5	1,60	48	76,80	20,6	12,9	1 016
Wandfliese wall tile	20x40	198x398x7	EN 14411 - L BIII	20	12,5	1,60	48	76,80	20,6	12,9	1 016
Bordüre listel	40x4,8	398x48x7	EN 14411 - L BIII	7	52,1	0,13	-	-	1,8	13,6	-
Bordüre relief listel	40x2	398x20	STO No. 030 - 060753	12	125	0,09	-	-	1,7	18,9	-
Mosaik set 30x30 cm mosaic sheet 30x30 cm	5x5	48x48x7	STO No. 030 - 059826	3/4	11	0,27/0,36	-	-	3,5/4,8	12,9	-

Das Produkt zeigt die individuellen Designmöglichkeiten auf in jeder Verpackung. | This product is deliberately mixed in packing to include a random selection of designs.

20x40

40x2

5x5 | 30x30

V2



60x120
R10/B
v3
R



DARV1722*
DARV9722**
PEI 5 ○ 700 l m²
relief matt
weiß | white



DARV1720*
DARV9720**
PEI 5 ○ 700 l m²
relief matt
elfenbein | ivory

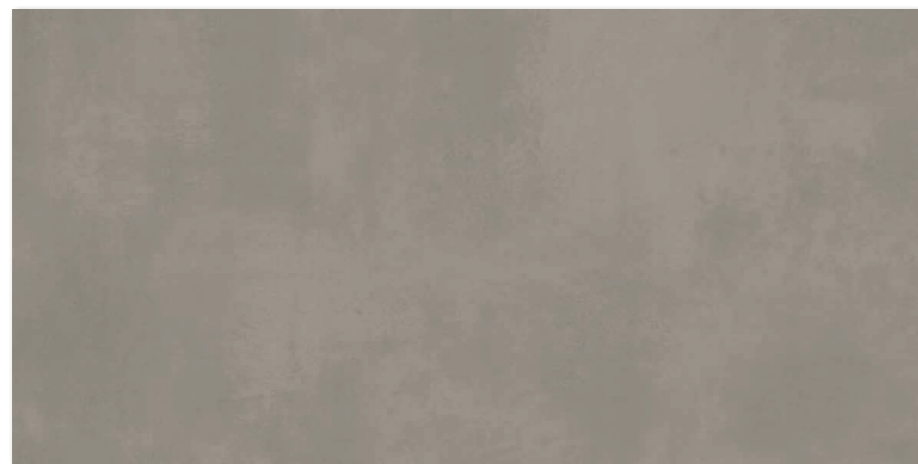

DARV1721*
DARV9721**
PEI 4 ○ 700 l m²
relief matt
braun-grau | brown-grey



60x120
R10/B
v3
R



DARV1723*
DARV9723**
PEI 4 ○ 700 l m²
relief matt
hellgrau | light grey



DARV1724*
DARV9724**
PEI 4 ○ 700 l m²
relief matt
dunkelgrau | dark grey

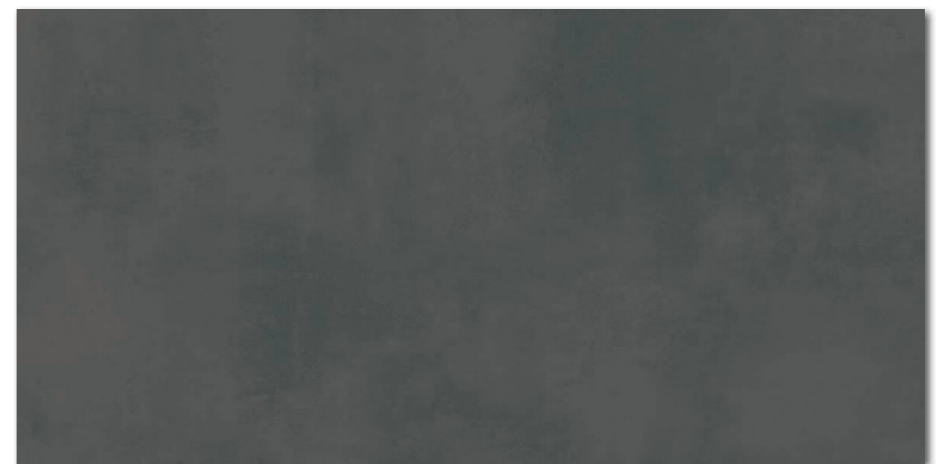

DARV1725*
DARV9725**
PEI 4 ○ 700 l m²
relief matt
schwarz | black

Produkt | product



Bodenfliese floor tile*	60x120	598x1198x10	EN 14411 - G Bla	2	1,4	1,44	27	38,88	32,7	22,7	908
Bodenfliese floor tile**	60x120	598x1198x9	EN 14411 - G Bla	2	1,4	1,44	30	43,20	29,3	20,4	905

* Verfügbar solange der Vorrat reicht | Available while stocks last

** Neues Produkt in 9 mm Stärke im Laufe des Jahres 2025 verfügbar | New product in 9 mm thickness available during 2025



DAR81722
PEI 5 ○ 700 l m²
relief matt

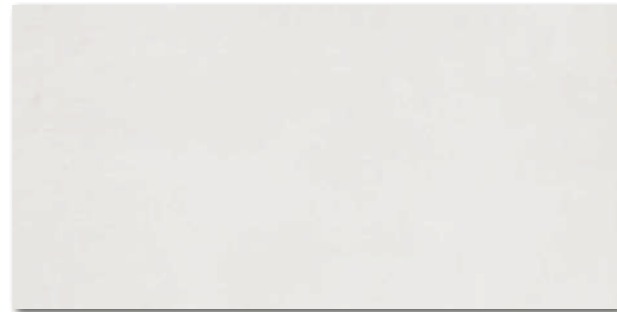

DAR84722
PEI 5 ○ 720 l m²
relief matt
weiß | white



DAR81720
PEI 5 ○ 700 l m²
relief matt

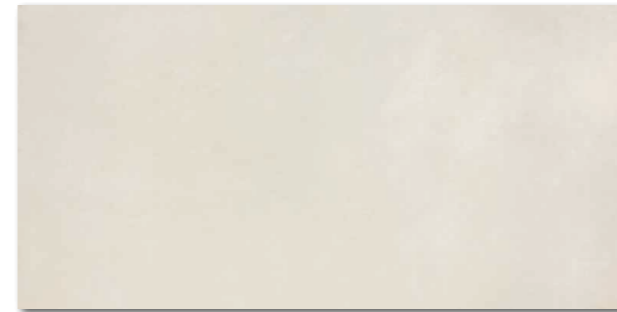

DAR84720
PEI 5 ○ 720 l m²
relief matt
elfenbein | ivory



DAR81721
PEI 4 ○ 700 l m²
relief matt



DAR84721
PEI 4 ○ 720 l m²
relief matt
braun-grau | brown-grey

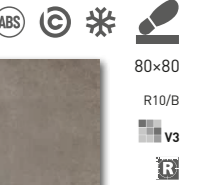

80x80
R10/B
v3
R

40x80
R10/B
v3
R

RAKO Home

Produkt | product



Bodenfliese floor tile	80-80	798-798-10	EN 14411 - G Bla	2	1,6	1,28	42	53,76	28,0	21,9	1.202
Bodenfliese floor tile	40-80	398-798-10	EN 14411 - G Bla	4	3,1	1,28	42	53,76	28,0	21,9	1.202

Empfohlene Formatkombinationen siehe Seite 522-523. | Recommended combinations of modular sizes see pages 522-523.

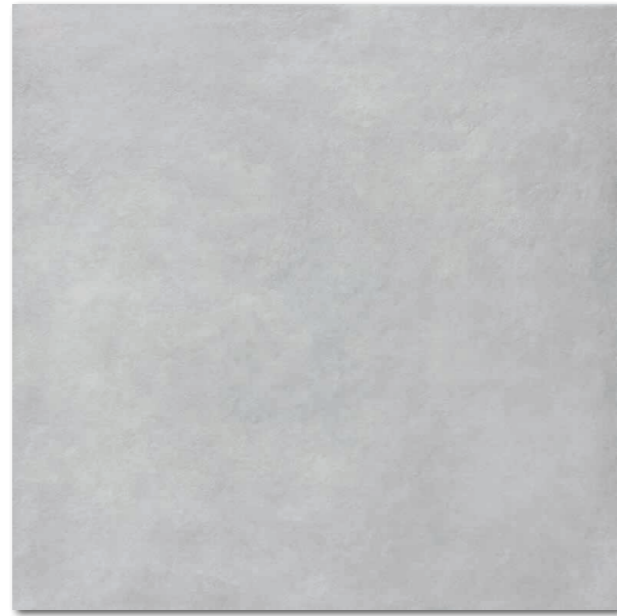

DAR81723
PEI 4 ○ 700 | m²
relief matt

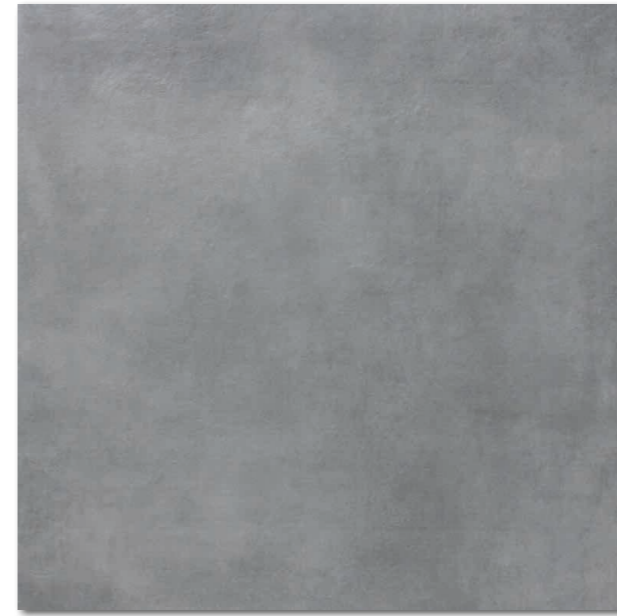

DAR81724
PEI 4 ○ 700 | m²
relief matt

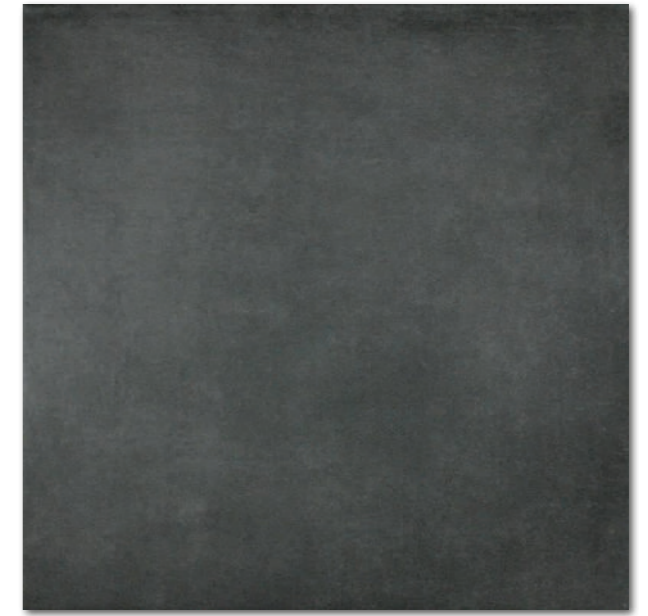

DAR81725
PEI 4 ○ 700 | m²
relief matt

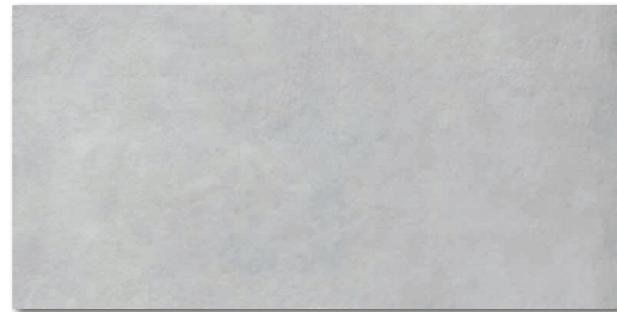
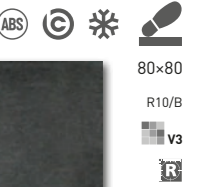

DAR84723
PEI 4 ○ 720 | m²
relief matt
hellgrau | light grey



DAR84724
PEI 4 ○ 720 | m²
relief matt
dunkelgrau | dark grey



DAR84725
PEI 4 ○ 720 | m²
relief matt
schwarz | black



Produkt | product



Bodenfliese floor tile	80-80	798-798-10	EN 14411 - G Bla	2	1,6	1,28	42	53,76	28,0	21,9	1 202
Bodenfliese floor tile	40-80	398-798-10	EN 14411 - G Bla	4	3,1	1,28	42	53,76	28,0	21,9	1 202

Empfohlene Formatkombinationen siehe Seite 522-523. | Recommended combinations of modular sizes see pages 522-523.



60x60
R10/B
v3
R

30x60
R10/B
v3
R

45x45
R10/B
v3
R

RAKO Home

30x45
R10/B
v3
R

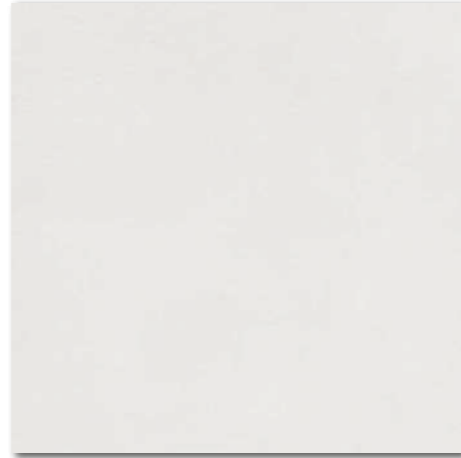

DAR63722*
DAR62722**
PEI 5 ○ 560 l m²
relief matt

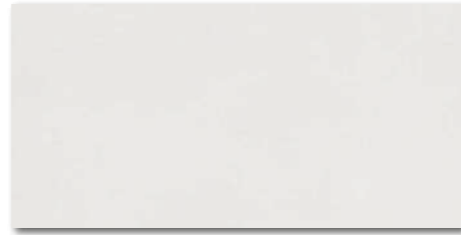

DARSE722*
DARSR722**
PEI 5 ○ 540 l m²
relief matt

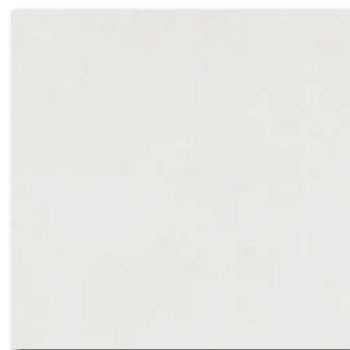

DAR4H722
PEI 5 ○ 520 l m²
relief matt



DDVP4722 (SHEET)
PEI 5 ○ 610 l Netz
relief matt
weiß | white

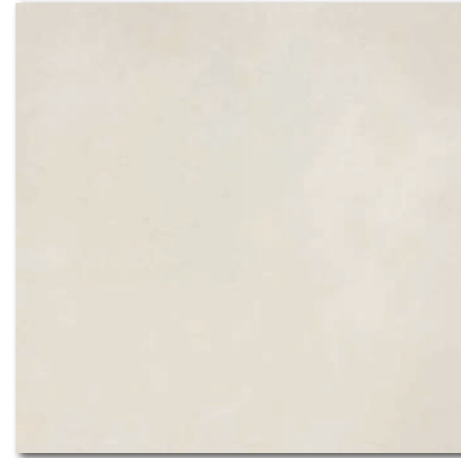

DAR63720*
DAR62720**
PEI 5 ○ 560 l m²
relief matt

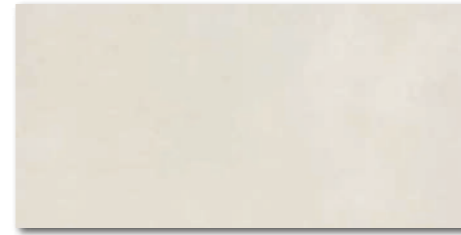

DARSE720*
DARSR720**
PEI 5 ○ 540 l m²
relief matt

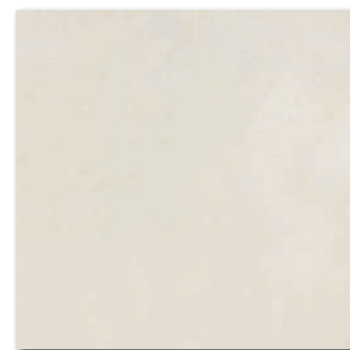

DAR4H720
PEI 5 ○ 520 l m²
relief matt



DDVP4720 (SHEET)
PEI 5 ○ 610 l Netz
relief matt
elfenbein | ivory



DAR63721*
DAR62721**
PEI 4 ○ 560 l m²
relief matt



DARSE721*
DARSR721**
PEI 4 ○ 540 l m²
relief matt



DAR4H721
PEI 4 ○ 520 l m²
relief matt



DDVP4721 (SHEET)
PEI 4 ○ 610 l Netz
relief matt
braun-grau | brown-grey

Produkt product	cm	mm	EN	Stk/m ²	Stk/m ²	Stk/m ²	Stk/m ²	Stk/m ²	Stk/m ²	Stk/m ²	Stk/m ²
Bodenfliese floor tile*	60x60	598-598x10	EN 14411 - G Bla	3	2,8	1,08	32	34,56	23,7	21,9	782
Bodenfliese floor tile**	60x60	598x598x9	EN 14411 - G Bla	4	2,8	1,44	32	46,08	29,1	20,2	955
Bodenfliese floor tile*	30x60	298-598x10	EN 14411 - G Bla	6	5,6	1,08	40	43,20	23,7	21,9	971
Bodenfliese floor tile**	30x60	298x598x9	EN 14411 - G Bla	7	5,6	1,26	40	50,40	24,2	19,2	993
Bodenfliese floor tile	45x45	445-445x8	EN 14411 - G Bla	6	5	1,21	34	41,14	21,1	17,4	741
Bodenfliese floor tile	30x45	298-445x8	EN 14411 - G Bla	5	7,4	0,68	36	-	10,5	17,4	-

* Verfügbar solange der Vorrat reicht | Available while stocks last

** Neues Produkt in 9 mm Stärke im Laufe des Jahres 2025 verfügbar | New product in 9 mm thickness available during 2025

Empfohlene Formatkombinationen siehe Seite 522-523. | Recommended combinations of modular sizes see pages 522-523.

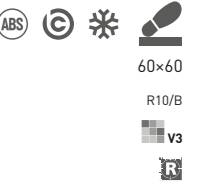

60x60
R10/B
v3
R

30x60
R10/B
v3
R

45x45
R10/B
v3
R

RAKO Home

30x45
R10/B
v3
R



DAR63723*
DAR62723**
PEI 4 ○ 560 l m²
relief matt



DARSE723*
DARSR723**
PEI 4 ○ 540 l m²
relief matt



DAR4H723
PEI 4 ○ 520 l m²
relief matt



DDVP4723 (SHEET)
PEI 4 ○ 610 l Netz
relief matt
hellgrau | light grey

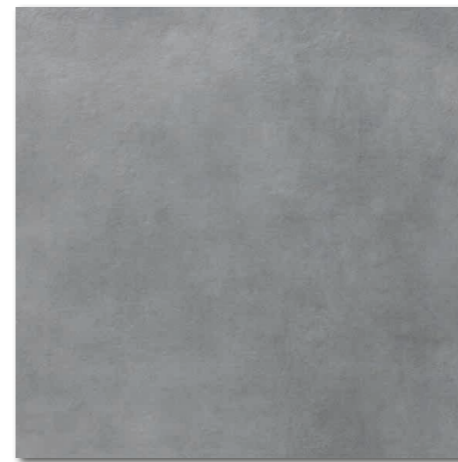

DAR63724*
DAR62724**
PEI 4 ○ 560 l m²
relief matt



DARSE724*
DARSR724**
PEI 4 ○ 540 l m²
relief matt

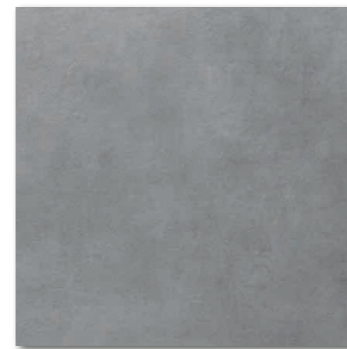

DAR4H724
PEI 4 ○ 520 l m²
relief matt



DDVP4724 (SHEET)
PEI 4 ○ 610 l Netz
relief matt
dunkelgrau | dark grey



DAR63725*
DAR62725**
PEI 4 ○ 560 l m²
relief matt



DARSE725*
DARSR725**
PEI 4 ○ 540 l m²
relief matt



DAR4H725
PEI 4 ○ 520 l m²
relief matt



DDVP4725 (SHEET)
PEI 4 ○ 610 l Netz
relief matt
schwarz | black

Produkt product	cm	mm	EN	Stk/m ²	Stk/m ²	Stk/m ²	Stk/m ²	Stk/m ²	Stk/m ²	Stk/m ²	Stk/m ²
Bodenfliese floor tile*	60x60	598x598x10	EN 14411 - G Bla	3	2,8	1,08	32	34,56	23,7	21,9	782
Bodenfliese floor tile**	60x60	598x598x9	EN 14411 - G Bla	4	2,8	1,44	32	46,08	29,1	20,2	955
Bodenfliese floor tile*	30x60	298x598x10	EN 14411 - G Bla	6	5,6	1,08	40	43,20	23,7	21,9	971
Bodenfliese floor tile**	30x60	298x598x9	EN 14411 - G Bla	7	5,6	1,26	40	50,40	24,2	19,2	993
Bodenfliese floor tile	45x45	445x445x8	EN 14411 - G Bla	6	5	1,21	34	41,14	21,1	17,4	741
Bodenfliese floor tile	30x45	298x445x8	EN 14411 - G Bla	5	7,4	0,68	36	-	10,5	17,4	-

* Verfügbar solange der Vorrat reicht | Available while stocks last

** Neues Produkt in 9 mm Stärke im Laufe des Jahres 2025 verfügbar | New product in 9 mm thickness available during 2025

Empfohlene Formatkombinationen siehe Seite 522-523. | Recommended combinations of modular sizes see pages 522-523.



30x30
20x20
10x10
5x5 | 30x30

R10/B
v3

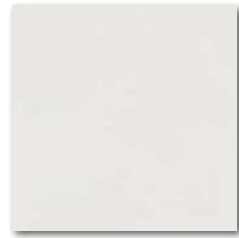

DAR34722
PEI 5 ○ 390 | m²
relief matt
weiß | white



DAR26722*
DAR25722**
PEI 5 ○ 780 | m²
relief matt | 15



DAR12722* (SHEET)
DAR11722**
PEI 5 ○ 900 | m²
relief matt | >6 | 15



DDM06722* (SHEET)
DDM05722**
PEI 5 ○ 300 | Netz
relief matt | >6 | 15



DAR34723
PEI 4 ○ 390 | m²
relief matt
hellgrau | light grey



DAR26723*
DAR25723**
PEI 4 ○ 780 | m²
relief matt | 15



DAR12723* (SHEET)
DAR11723**
PEI 4 ○ 900 | m²
relief matt | >6 | 15



DDM06723* (SHEET)
DDM05723**
PEI 4 ○ 300 | Netz
relief matt | >6 | 15



30x30
20x20
10x10
5x5 | 30x30

R10/B
v3



DAR34720
PEI 5 ○ 390 | m²
relief matt
elfenbein | ivory



DAR26720*
DAR25720**
PEI 5 ○ 780 | m²
relief matt | 15



DAR12720* (SHEET)
DAR11720**
PEI 5 ○ 900 | m²
relief matt | >6 | 15



DDM06720* (SHEET)
DDM05720**
PEI 5 ○ 300 | Netz
relief matt | >6 | 15



DAR34724
PEI 4 ○ 390 | m²
relief matt
dunkelgrau | dark grey



DAR26724*
DAR25724**
PEI 4 ○ 780 | m²
relief matt | 15



DAR12724* (SHEET)
DAR11724**
PEI 4 ○ 900 | m²
relief matt | >6 | 15

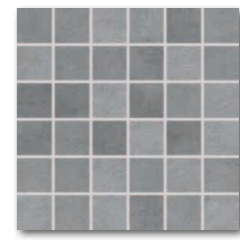

DDM06724* (SHEET)
DDM05724**
PEI 4 ○ 300 | Netz
relief matt | >6 | 15



DAR34721
PEI 4 ○ 390 | m²
relief matt
braun-grau | brown-grey



DAR26721*
DAR25721**
PEI 4 ○ 780 | m²
relief matt | 15



DAR12721* (SHEET)
DAR11721**
PEI 4 ○ 900 | m²
relief matt | >6 | 15



DDM06721* (SHEET)
DDM05721**
PEI 4 ○ 300 | Netz
relief matt | >6 | 15



DAR34725
PEI 4 ○ 390 | m²
relief matt
schwarz | black



DAR26725*
DAR25725**
PEI 4 ○ 780 | m²
relief matt | 15

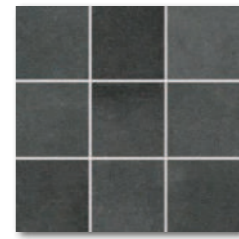

DAR12725* (SHEET)
DAR11725**
PEI 4 ○ 900 | m²
relief matt | >6 | 15

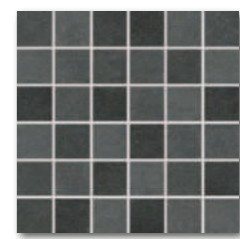

DDM06725* (SHEET)
DDM05725**
PEI 4 ○ 300 | Netz
relief matt | >6 | 15

Produkt product	mm	mm	EN	St/m ²	kg/m ²	kg/m ²	kg/m ²	kg/m ²	kg/m ²	kg/m ²	kg/m ²
Bodenfliese floor tile	30x30	298x298-8	EN 14411 - G Bla	13	11	1,18	48	56,64	20,5	17,4	1 011
Bodenfliese floor tile*	20x20	197x197-10	EN 14411 - G Bla	23	25	0,92	57	52,44	20,1	21,9	1 174
Bodenfliese floor tile**	20x20	197x197-9	EN 14411 - G Bla	25	25	1,00	57	57,00	19,2	19,2	1 119
Bodenfliese floor tile	10x10	98x98-10	EN 14411 - G Bla	10	11	0,91	56	50,96	19,9	21,9	1 142
Bodenfliese floor tile**	10x10	98x98-9	EN 14411 - G Bla	11	11	1,00	56	56,00	19,2	19,2	1 125
Mosaik set 30x30 cm mosaic sheet 30x30 cm*	5x5	48x48-10	EN 14411 - G Bla	3	11	0,27	-	-	5,9	-	-
Mosaik 30x30 cm mosaic sheet 30x30 cm**	5x5	48x48-9	EN 14411 - G Bla	3	11	0,27	-	-	5,2	-	-

* Verfügbar solange der Vorrat reicht | Available while stocks last

** Neues Produkt in 9 mm Stärke im Laufe des Jahres 2025 verfügbar | New product in 9 mm thickness available during 2025

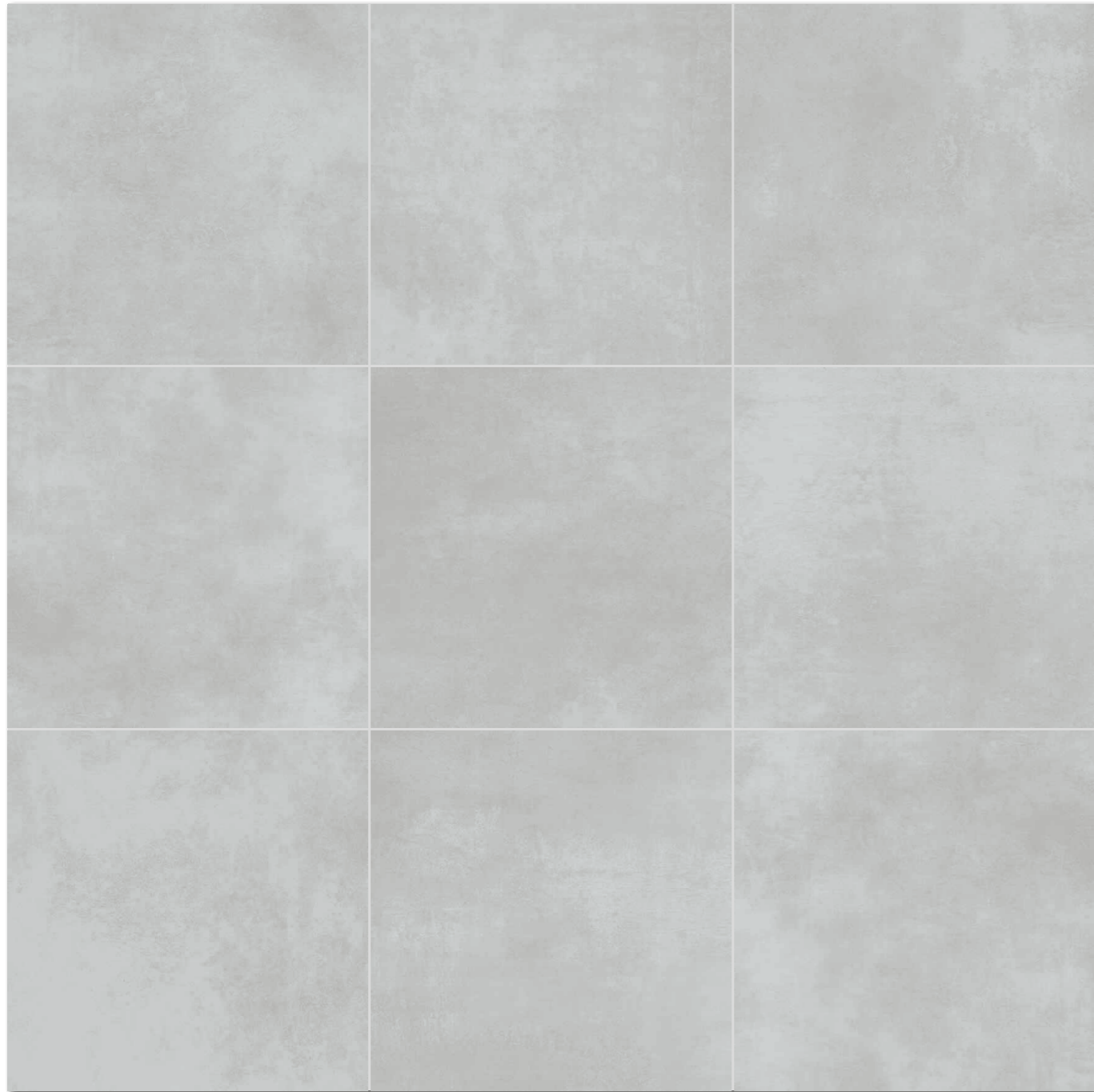

Die Fliesen der Serie zeichnen sich durch ein breites Farbspiel V3 aus. | All products of the entire batch show big deviations in shade difference V3.

Wir empfehlen, einzelne Fliesen aus mehreren Paketen herauszunehmen und den gesamten Bodenbelag nach der Inspirationsfotodokumentation in den Katalogen RAKO, eventuell den Webseiten www.rako.eu, zu komponieren. Wünschenswert ist die Kombination aller Fliesendesigns einschließlich ihrer Drehung um 90° oder 180°, sodass ausgewogene Optik der verlegten Fläche erzielt wird.

Before laying the tiles, we suggest you select from several cartons and arrange them as illustrated in the inspiration photo documentation in RAKO catalogues or website www.rako.eu, and mix the tiles to achieve the required result including turning them by 90° or 180°.

Produkt product	cm	mm	EN	St/m²	kg/m²	St/m²	kg/m²	St/m²	kg/m²	St/m²	kg/m²	St/m²	kg/m²
Stufe step tile*	30x120	298x1198x10	EN 14411 - G Bla	3/5	2,8	1,08/1,8	-	-	24,6/40,9	22,7	-	-	-
Stufe step tile**	30x120	298x1198x9	EN 14411 - G Bla	3	2,8	1,08	-	-	22,5	-	-	-	-
Stufe step tile	40x80	398x798x10	EN 14411 - G Bla	2	3,1	0,64	-	-	14,1	-	-	-	-
Stufe step tile*	30x60	298x598x10	EN 14411 - G Bla	6	5,6	1,08	-	-	23,7	-	-	-	-
Stufe step tile**	30x60	298x598x9	EN 14411 - G Bla	5	5,6	0,90	-	-	17,3	-	-	-	-
Sockel skirting plinth	80x9,5	798x95x10	EN 14411 - G Bla	10	13,2	0,76	-	-	16,7	-	-	-	-
Sockel skirting plinth*	60x9,5	598x95x10	EN 14411 - G Bla	13	17,5	0,74	-	-	16,2	-	-	-	-
Sockel skirting plinth**	60x7,2	598x72x9	EN 14411 - G Bla	14	23,1	0,60	-	-	11,5	-	-	-	-
Sockel skirting plinth	45x8,5	448x85x8	EN 14411 - G Bla	25	26,1	0,96	-	-	16,7	-	-	-	-
Stufenformteil special step tile	40x80	398x798x10	STO No. 030 - 059824	2	-	-	-	-	16,5	-	-	-	-
Stufenformteil special step tile*	30x120	298x1198x10	STO No. 030 - 059824	2	-	-	-	-	-	-	-	-	-
Stufenformteil special step tile**	30x120	298x1198x9	STO No. 030 - 059824	2	-	-	-	-	-	-	-	-	-

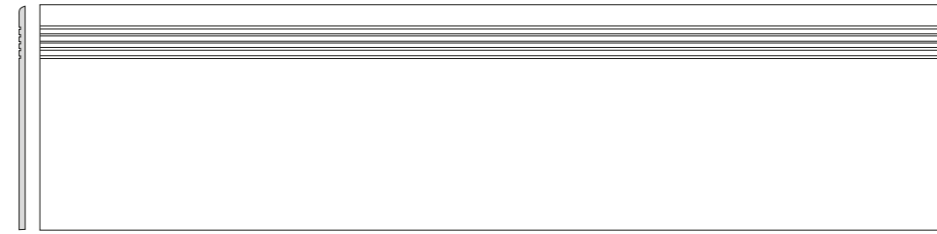

30x120
R10/B
v3
R

DCPVF720* | **DCPVD720**** elfenbein | ivory
DCPVF721* | **DCPVD721**** braun-grau | brown-grey
DCPVF722* | **DCPVD722**** weiß | white
DCPVF723* | **DCPVD723**** hellgrau | light grey
DCPVF724* | **DCPVD724**** dunkelgrau | dark grey
DCPVF725* | **DCPVD725**** schwarz | black
PEI 4-5 ○ 740 | St
relief matt

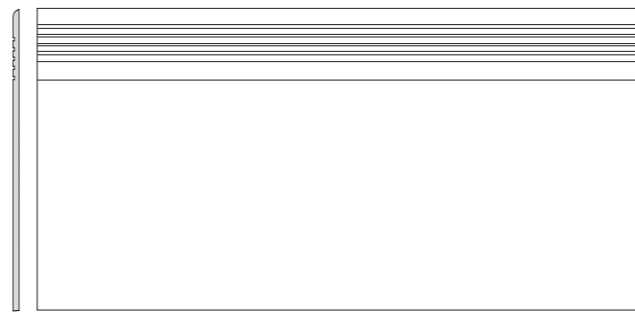

40x80
30x60
R10/B
v3
R

DCP84720 elfenbein | ivory
DCP84721 braun-grau | brown-grey
DCP84722 weiß | white
DCP84723 hellgrau | light grey
DCP84724 dunkelgrau | dark grey
DCP84725 schwarz | black
PEI 4-5 ○ 380 | St
relief matt

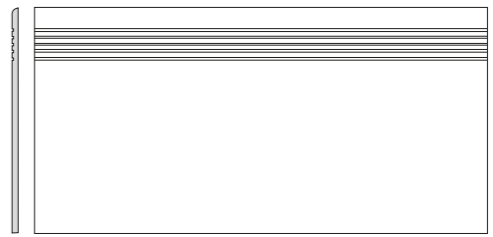

DCPSE720* | **DCPSR720**** elfenbein | ivory
DCPSE721* | **DCPSR721**** braun-grau | brown-grey
DCPSE722* | **DCPSR722**** weiß | white
DCPSE723* | **DCPSR723**** hellgrau | light grey
DCPSE724* | **DCPSR724**** dunkelgrau | dark grey
DCPSE725* | **DCPSR725**** schwarz | black
PEI 4-5 ○ 270 | St
relief matt



60x9,5
60x9,5*
60x7,2**
R

DSA89720 elfenbein | ivory
DSA89721 braun-grau | brown-grey
DSA89722 weiß | white
DSA89723 hellgrau | light grey
DSA89724 dunkelgrau | dark grey
DSA89725 schwarz | black
○ 210 | St
relief matt



DSAS4720* | **DSAS3720**** elfenbein | ivory
DSAS4721* | **DSAS3721**** braun-grau | brown-grey
DSAS4722* | **DSAS3722**** weiß | white
DSAS4723* | **DSAS3723**** hellgrau | light grey
DSAS4724* | **DSAS3724**** dunkelgrau | dark grey
DSAS4725* | **DSAS3725**** schwarz | black
○ 180 | St
relief matt



45x8,5
R

DSAPS720 elfenbein | ivory
DSAPS721 braun-grau | brown-grey
DSAPS722 weiß | white
DSAPS723 hellgrau | light grey
DSAPS724 dunkelgrau | dark grey
DSAPS725 schwarz | black
○ 160 | St
relief matt

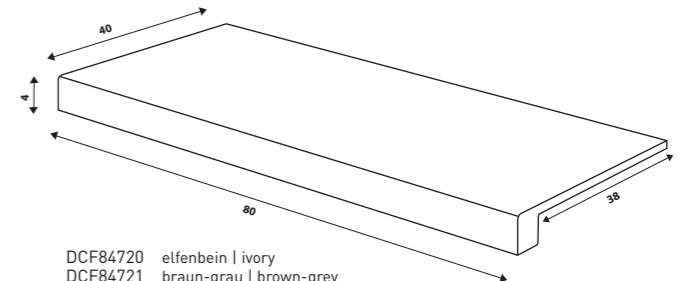

40x80
R10/B
v3
R

DCF84720 elfenbein | ivory
DCF84721 braun-grau | brown-grey
DCF84722 weiß | white
DCF84723 hellgrau | light grey
DCF84724 dunkelgrau | dark grey
DCF84725 schwarz | black
PEI 4-5 ○ 1130 | St
relief matt

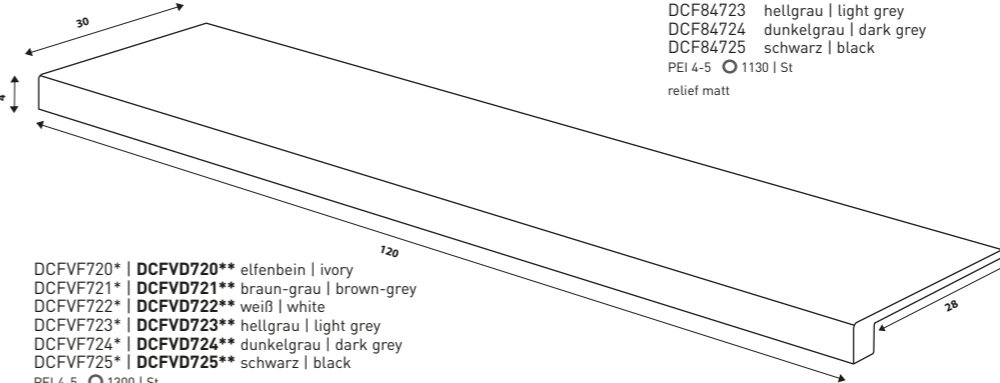

30x120
R10/B
v3
R

DCFVF720* | **DCFVD720**** elfenbein | ivory
DCFVF721* | **DCFVD721**** braun-grau | brown-grey
DCFVF722* | **DCFVD722**** weiß | white
DCFVF723* | **DCFVD723**** hellgrau | light grey
DCFVF724* | **DCFVD724**** dunkelgrau | dark grey
DCFVF725* | **DCFVD725**** schwarz | black
PEI 4-5 ○ 1300 | St
relief matt

* Verfügbar solange der Vorrat reicht | Available while stocks last

** Neues Produkt in 9 mm Stärke im Laufe des Jahres 2025 verfügbar | New product in 9 mm thickness available during 2025



WAKV5333
○ 750 l m²
matt

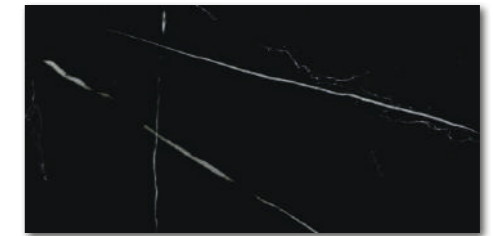

WAKV4333*
WAKVK333
○ 500 l m²
matt

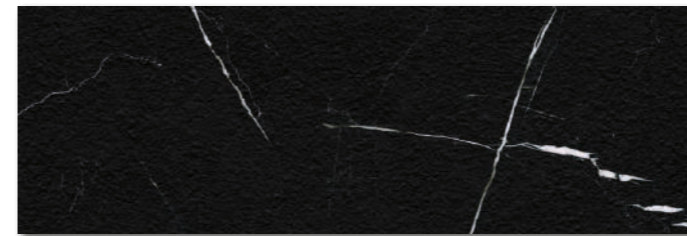

WARV5333
○ 750 l m²
relief matt
schwarz | black



WARV4333*
WARVK333
○ 500 l m²
relief matt
schwarz | black



WAKV5233
Vein
○ 710 l m²
matt
weiß | white

WAKV5133
Vein
○ 710 l m²
glossy

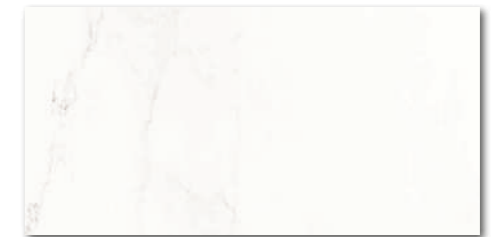

WAKVK233
Vein
○ 500 l m²
matt
weiß | white

WAKVK133
Vein
○ 500 l m²
glossy



WDVT8333
○ 580 l Netz
matt
mehrfarbig | multicoloured

(SHEET)



30x90
30x60

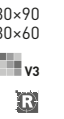

30x90
30x60



RAKO Home



52,5x30



Produkt product	cm	mm	EN	St/m ²	St/m ²	St/m ²	St/m ²	St/m ²	St/m ²	kg/m ²	kg/m ²
Wandfliese wall tile	30x90	298-898-10	EN 14411 - L BIII	4	3,7	1,08	30	32,40	20,0	18,5	625
Wandfliese wall tile*	30x60	298-598-10	EN 14411 - L BIII	6	5,56	1,08	40	43,20	20,0	18,5	825
Wandfliese wall tile	30x60	298-598-8	EN 14411 - L BIII	8	5,56	1,44	40	57,60	21,3	14,8	876
Dekor decor	15/8,5	145/84-8	STO No. 030 - 059826	5	8,9	0,56	-	-	9,2	16,5	-

* Verfügbar solange der Vorrat reicht | Available while stocks last

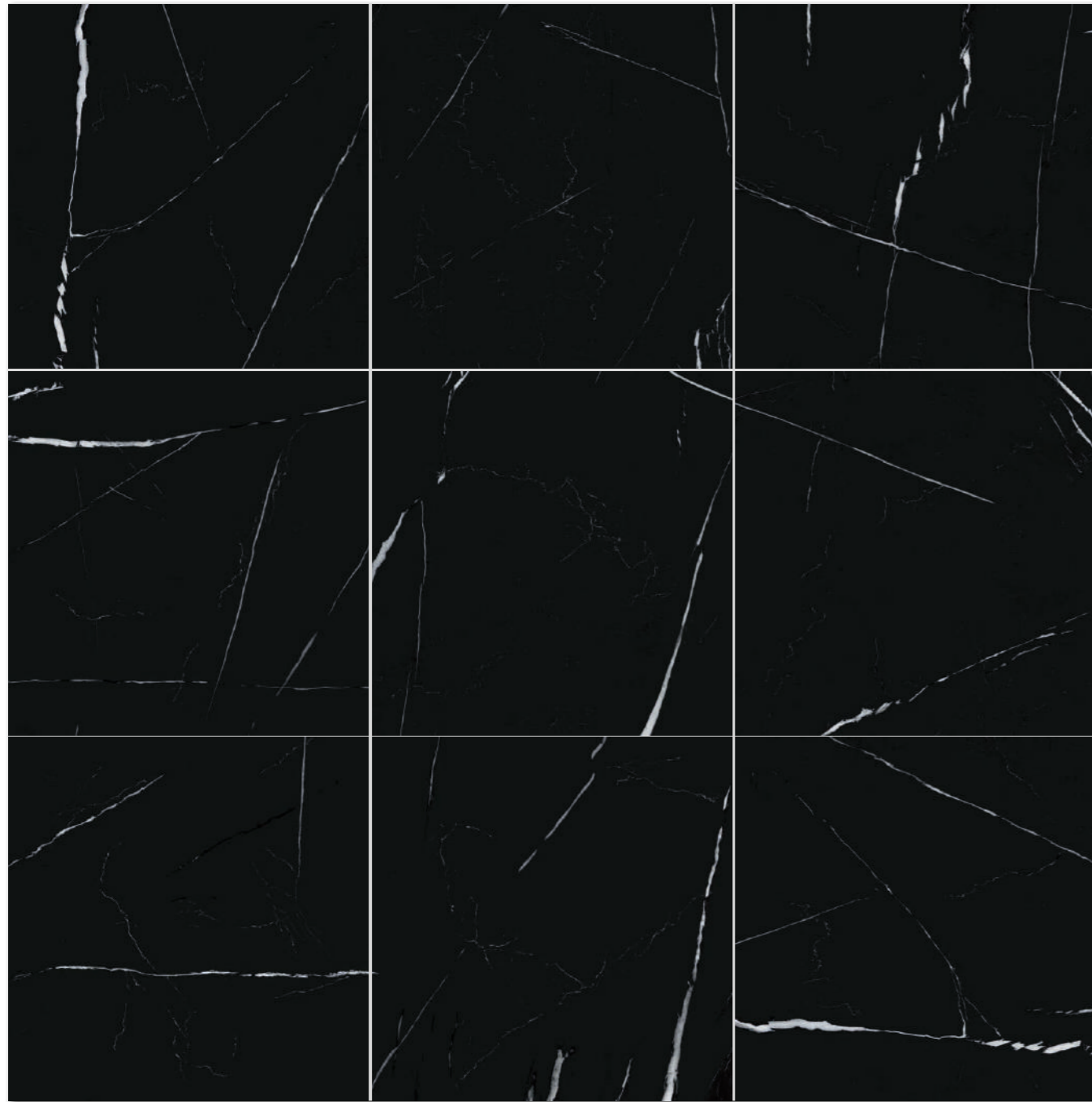

Die Fliesen der Serie zeichnen sich durch ein breites Farbspiel V4 aus. | All products of the entire batch show big deviations in shade difference V4.

Wir empfehlen, einzelne Fliesen aus mehreren Paketen herauszunehmen und den gesamten Bodenbelag nach der Inspirationsfotodokumentation in den Katalogen RAKO, eventuell den Webseiten www.rako.eu, zu komponieren. Wünschenswert ist die Kombination aller Fliesendesigns einschließlich ihrer Drehung um 90° oder 180°, sodass ausgewogene Optik der verlegten Fläche erzielt wird.

Before laying the tiles, we suggest you select from several cartons and arrange them as illustrated in the inspiration photo documentation in RAKO catalogues or website www.rako.eu, and mix the tiles to achieve the required result including turning them by 90° or 180°.

Produkt product	cm	mm	EN	St/m ²	kg/m ²	St/m ²	kg/m ²	St/m ²	kg/m ²	St/m ²	kg/m ²
Bodenfliese floor tile*	60x60	598x598x10	EN 14411 - G Bla	3	2,8	1,08	32	34,56	23,7	21,9	782
Bodenfliese floor tile**	60x60	598x598x9	EN 14411 - G Bla	4	2,8	1,44	32	46,08	29,1	20,2	955
Mosaik set 30x30 cm mosaic sheet 30x30 cm*	5x5	48x48x10	EN 14411 - G Bla	3	11	0,27	-	-	5,9	-	-
Mosaik 30x30 cm mosaic sheet 30x30 cm**	5x5	48x48x9	EN 14411 - G Bla	3	11	0,27	-	-	5,2	-	-
Stufe step tile*	60x60	598x597x10	EN 14411 - G Bla	6	5,6	1,08	-	-	23,7	-	-
Stufe step tile**	60x60	598x597x9	EN 14411 - G Bla	3	2,8	1,08	-	-	21,9	-	-
Stufenformteil special step tile*	60x53	598x530x10	STO No. 030 - 059824	2	-	-	-	-	-	-	-
Stufenformteil special step tile**	60x53	598x530x9	STO No. 030 - 059824	2	-	-	-	-	-	-	-
Sockel skirting plinth*	60x9,5	598x95x10	EN 14411 - G Bla	13	17,5	0,74	-	-	16,2	-	-
Sockel skirting plinth**	60x7,2	598x72x9	EN 14411 - G Bla	14	23,1	0,60	-	-	11,5	-	-

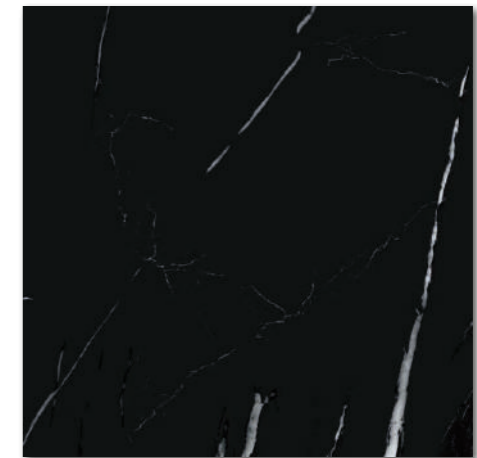

DAK63833*
DAK62833**
PEI 3 ○ 560 | m²
matt

60x60
R9/A
v4

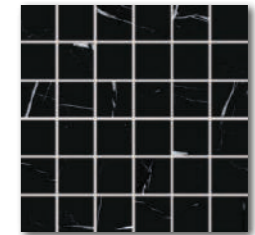

DDM06833* (SHEET)
DDM05833**
PEI 3 ○ 300 | Netz
matt

5x5 | 30x30
R10/B
v4

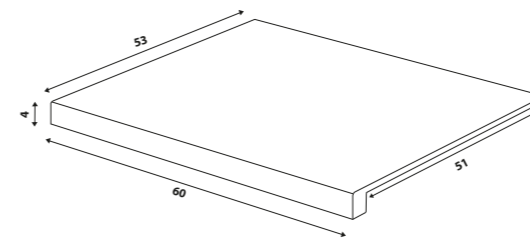

DCF65833*
DCF64833**
PEI 3 ○ 900 | St
matt



DCP63833*
DCP62833**
PEI 3 ○ 370 | St
matt

60x53
60x60
R9/A
v4



DSAS4833*
DSAS3833**
○ 180 | St
matt
schwarz | black

60x9,5*
60x7,2**

* Verfügbar solange der Vorrat reicht | Available while stocks last

** Neues Produkt in 9 mm Stärke im Laufe des Jahres 2025 verfügbar | New product in 9 mm thickness available during 2025

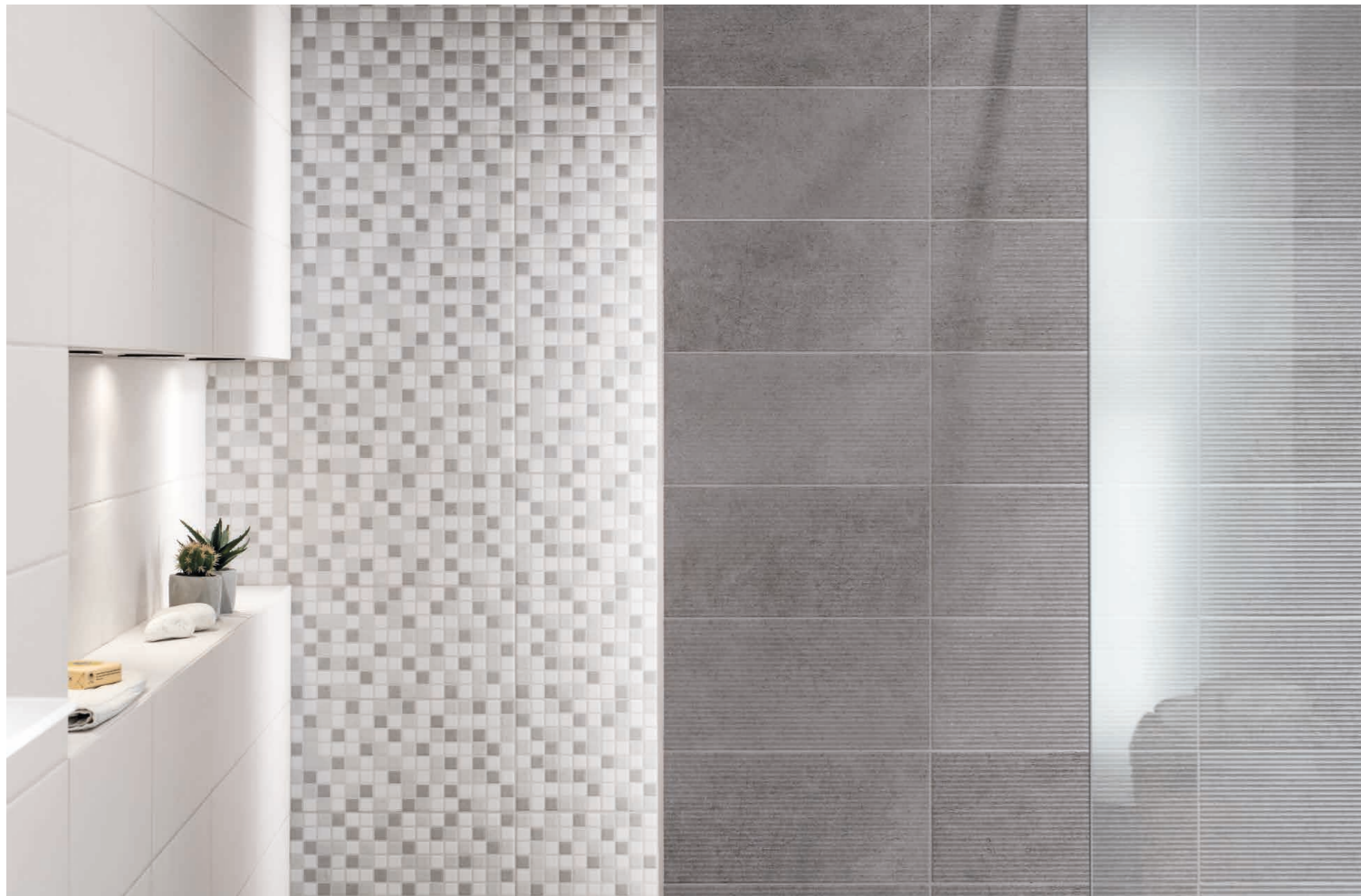

DAA34695
PEI 5 ○ 390 l m²
matt



DAA34696
PEI 4 ○ 390 l m²
matt



DAA34697
PEI 4 ○ 390 l m²
matt

© ❄️ 🖌️
30x30
R9/A
v3



DDM05695 (SHEET)
PEI 5 ○ 300 l Netz
matt
hellgrau | light grey



DDM05696 (SHEET)
PEI 4 ○ 300 l Netz
matt

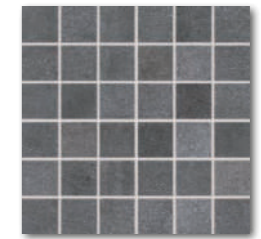

DDM05697 (SHEET)
PEI 4 ○ 300 l Netz
matt

5x5 | 30x30
✂️
R10/A
v3
F



DDR05696* (SHEET)
PEI 4 ○ 440 l Netz
relief matt
grau | grey

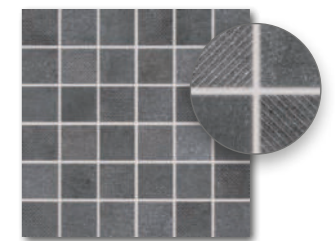

DDR05697* (SHEET)
PEI 4 ○ 440 l Netz
relief matt
dunkelgrau | dark grey

RAKO Home

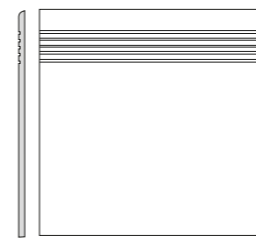

DCP34695 hellgrau | light grey
DCP34696 grau | grey
DCP34697 dunkelgrau | dark grey
PEI 4-5 ○ 150 l St
matt



DSAJ8695 hellgrau | light grey
DSAJ8696 grau | grey
DSAJ8697 dunkelgrau | dark grey
○ 110 l St
matt

30x30
R9/A
v3

30x7,2

Produkt | product



Produkt product	cm	mm	EN	mm	St/m ²	kg/m ²	cm	cm	kg	cm	kg
Bodenfliese floor tile	30-30	298-298-8	EN 14411 - G Bla	13	11	1,18	48	56,64	20,5	17,4	1 011
Mosaik set 30x30 cm mosaic sheet 30x30 cm	5x5	48x48x8	EN 14411 - G Bla	3/4	11	0,27/0,36	-	-	4,7/6,2	17,4	-
Stufe step tile	30-30	298-298-8	EN 14411 - G Bla	13	11	1,18	52	-	20,5	17,4	-
Sockel skirting plinth	30x7,2	298-72x8	EN 14411 - G Bla	30	46,3	0,65	-	-	11,3	17,4	-

* Verfügbar solange der Vorrat reicht | Available while stocks last



20x60



WADVE694
 ○ 510 l m²
 matt | **V3**
 hellbeige | light beige

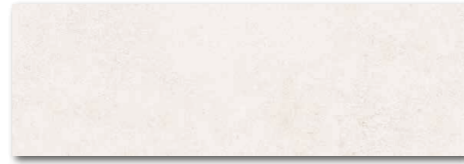

WADVE695
 ○ 510 l m²
 matt | **V3**
 hellgrau | light grey

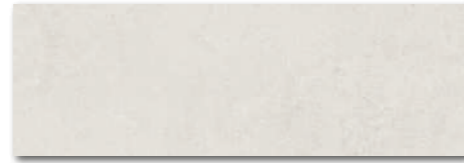

WADVE696
 ○ 510 l m²
 matt | **V3**
 grau | grey



WADVE697
 ○ 510 l m²
 matt | **V3**
 dunkelgrau | dark grey

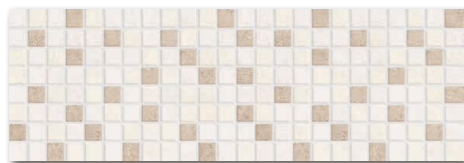

WARVE698
 ○ 510 l m²
 relief matt | **V4**
 beige | beige



WARVE699
 ○ 510 l m²
 relief matt | **V4**
 grau | grey

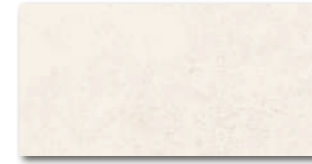

WADMB694
 ○ 400 l m²
 matt | **V3**

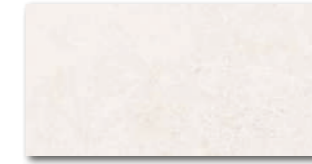

WADMB695
 ○ 400 l m²
 matt | **V3**



WADMB696
 ○ 400 l m²
 matt | **V3**
 grau | grey

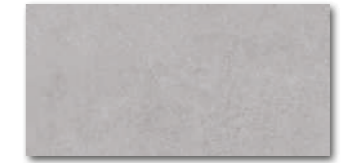

WADMB697
 ○ 400 l m²
 matt | **V3**
 dunkelgrau | dark grey

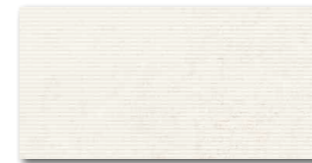

WARMB694
 ○ 440 l m²
 relief matt | **V3**
 hellbeige | light beige

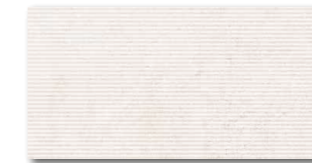

WARMB695
 ○ 440 l m²
 relief matt | **V3**
 hellgrau | light grey



WARMB696
 ○ 440 l m²
 relief matt | **V3**
 grau | grey

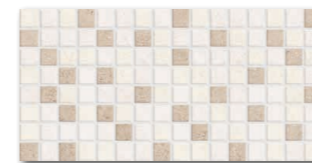

WARMB698
 ○ 440 l m²
 relief matt | **V4**
 beige | beige



WARMB699
 ○ 440 l m²
 relief matt | **V4**
 grau | grey

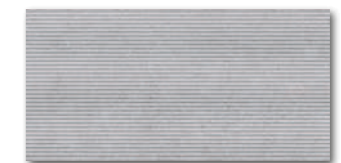

WARMB697
 ○ 440 l m²
 relief matt | **V3**
 dunkelgrau | dark grey



20x40

Produkt | product



Wandfliese wall tile	20x60	198x598-10	EN 14411 - L BIII	9	8,3	1,08	42	45,36	20,0	18,5	865
Wandfliese wall tile	20x40	198x398-7	EN 14411 - L BIII	20	12,5	1,60	48	76,80	20,6	12,9	1 016

Wir empfehlen die Kombination mit den Fliesen der Serie Pino 20x80, Form und Kaamos. | To combine with Pino 20x80, Form and Kaamos floor tiles is recommended.

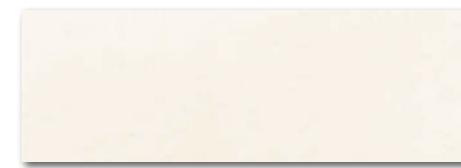

WADVE565
 ○ 510 | m²
 matt | **V2**
 hellbeige | light beige

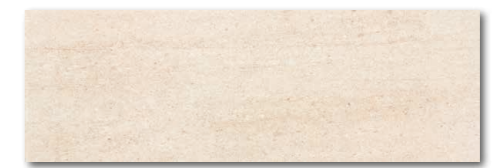

WADVE566
 ○ 510 | m²
 matt | **V2**



WARVE566
 ○ 510 | m²
 relief matt | **V3**

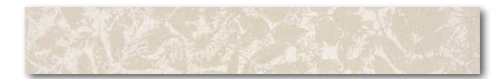

WLASP566
 ○ 350 | St
 matt
 beige | beige

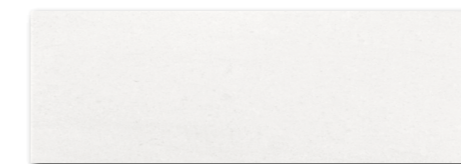

WADVE567
 ○ 510 | m²
 matt | **V2**
 hellgrau | light grey



WADVE568
 ○ 510 | m²
 matt | **V2**



WARVE568
 ○ 510 | m²
 relief matt | **V3**



WLASP568
 ○ 350 | St
 matt
 grau | grey



20x60

60x8,7

20x60

60x8,7

Produkt | product

	cm	mm	EN	St/m ²	kg/m ²	kg	kg	kg	kg	kg	kg
Wandfliese wall tile	20x60	198x598x10	EN 14411 - L BIII	9	8,3	1,08	42	45,36	20,0	18,5	865
Bordüre listel	60x8,7	598x87x10	EN 14411 - L BIII	10	18,5	0,53	-	-	9,1	18,5	-



WADMB565
 ○ 400 | m²
 matt | **V2**
 hellbeige | light beige



WADMB566
 ○ 400 | m²
 matt | **V2**



WADMB569
 ○ 440 | m²
 relief matt | **V3**

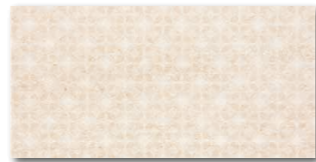

WADMB570
 ○ 440 | m²
 matt | **V3**



WLAMI566
 ○ 270 | St
 matt



WLRMG566
 ○ 270 | St
 relief matt



GLLJV100
 ○ 160 | St
 glossy
 beige | beige

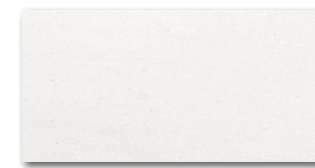

WADMB567
 ○ 400 | m²
 matt | **V2**
 hellgrau | light grey



WADMB568
 ○ 400 | m²
 matt | **V2**



WADMB571
 ○ 440 | m²
 relief matt | **V3**
 grau | grey

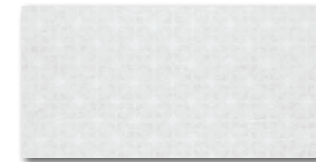

WADMB572
 ○ 440 | m²
 matt | **V3**



WLAMI568
 ○ 270 | St
 matt



WLRMG568
 ○ 270 | St
 relief matt
 grau | grey



GLLJV101
 ○ 160 | St
 glossy
 weiß-grau | white-grey



DAA4H566
 PEI 5 ○ 510 | m²
 matt
 beige | beige



DAA4H569
 PEI 4 ○ 510 | m²
 matt
 braun-grau | brown-grey



DAA4H568
 PEI 5 ○ 510 | m²
 matt
 grau | grey



DAA4H570
 PEI 3 ○ 510 | m²
 matt
 dunkelgrau | dark grey

20x40

40x6

40x2,3

30x2,5

45x45

R9/A

V2

RAKO Home

Produkt product	cm	mm	EN	St/m ²	kg/m ²	St/m ²	kg/m ²	St/m ²	kg/m ²	St/m ²	kg/m ²
Wandfliese wall tile	20x40	198x398x7	EN 14411 - L Billi	20	12,5	1,60	48	76,80	20,6	12,9	1 016
Bordüre listel	40x6	398x60x7	EN 14411 - L Billi	6	41,7	0,14	-	-	1,9	13,6	-
Bordüre relief listel	40x2,3	398x23	STO No. 030 - 060753	12	108,7	0,11	-	-	1,8	16,4	-
Bordüre listel	30x2,5	298x25x7	EN 1469 - 2005	48	133,3	0,36	-	-	5,8	16,0	-
Bodenfliese floor tile	45x45	448x448x8	EN 14411 - G Bia	6	5	1,21	34	41,14	21,1	17,4	741



20x60



WADVE033
○ 510 | m²
matt | V3
hellbeige | light beige



WADVE035
○ 510 | m²
matt | V4

60x8,7

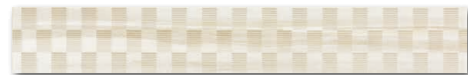

WLASP035
○ 540 | St
matt | glossy

60x1,5
5x5 | 30x30



WLASW001
○ 310 | St
matt
orange | orange



WLASW002
○ 310 | St
matt
bordo | bordo

20x60



WADVE036
○ 510 | m²
matt | V3



WADVE038
○ 510 | m²
matt | V4
hellgrau | light grey

60x8,7

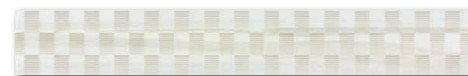

WLASP038
○ 540 | St
matt | glossy

60x1,5
5x5 | 30x30



WLASW003
○ 310 | St
matt
rot | red



WLASW004
○ 310 | St
matt
lila | violet



WADVE034
○ 510 | m²
matt | V3
beige | beige



WITVE033 (SET)
○ 830 | Set
matt

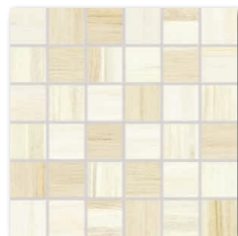

WDM06035 (SHEET)
○ 320 | Netz
matt | V4 | V3

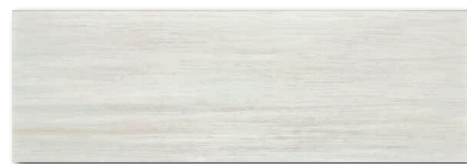

WADVE037
○ 510 | m²
matt | V3
grau | grey



WITVE036 (SET)
○ 830 | Set
matt



WDM06038 (SHEET)
○ 320 | Netz
matt | V4 | V3



15x20



WATDP259
○ 380 | m²
matt
beige | beige



WATDP257
○ 380 | m²
matt
grau | grey

WATDP258
○ 380 | m²
glossy

WATDP256
○ 380 | m²
glossy

Produkt product											
Wandfliese wall tile	20x60	198x598x10	EN 14411 - L BIII	9	8,3	1,08	42	45,36	20,0	18,5	865
Dekor (set) decor (set)	20x60	198x598x10	EN 14411 - L BIII	3	8,3	0,72	-	-	13,3	18,5	-
Bordüre listel	60x8,7	598x87x10	EN 14411 - L BIII	5/10	19,2	0,26/0,52	-	-	5,05/9,6	-	-
Bordüre listel	60x1,5	598x15x10	EN 14411 - L BIII	10	111,1	0,09	-	-	1,6	17,8	-
Mosaik set 30x30 cm mosaic sheet 30x30 cm	5x5	48x48x10	STO No. 030 - 059826	3	11	0,27	-	-	4,7	18,5	-
Wandfliese wall tile	15x20	148x198x6	EN 14411 - L BIII	33	33	1,00	100	100,00	10,0	10,0	1 045

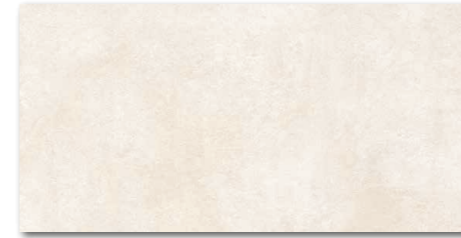

WADV687
 ○ 480 | m²
 matt | **V3**
 elfenbein | ivory



WADV690
 ○ 480 | m²
 mattglossy | **V4**
 elfenbein | ivory

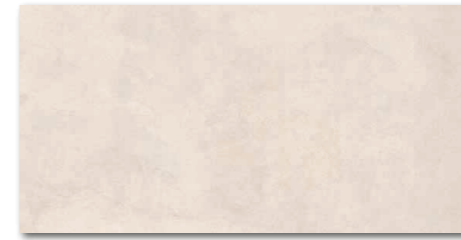

WADV688
 ○ 480 | m²
 matt | **V3**
 beige | beige



WADV691
 ○ 480 | m²
 mattglossy | **V4**
 beige | beige



WADV689
 ○ 480 | m²
 matt | **V3**
 grau | grey



WADV692
 ○ 480 | m²
 mattglossy | **V4**
 grau | grey

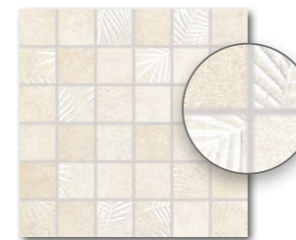

WDM05687 (SHEET)
 ○ 250 | Netz
 mattglossy
 elfenbein | ivory

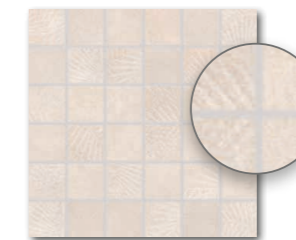

WDM05688 (SHEET)
 ○ 250 | Netz
 mattglossy
 beige | beige



WDM05689 (SHEET)
 ○ 250 | Netz
 mattglossy
 grau | grey



Produkt | product



Wandfliese wall tile	30x60	298x598x8	EN 14411 - L BIII	8	5,56	1,44	40	57,60	21,3	14,8	876
Mosaik set 30x30 cm mosaic sheet 30x30 cm	5x5	48x48x8	STO No. 030 - 059826	4	11	0,36	-	-	5,2	14,8	-

Die Produktverpackung enthält zufällige Designmöglichkeiten. | The products are deliberately mixed in packing to include a random selection of designs.

Wir empfehlen die Kombination mit den Fliesen der Serie Extra. | To combine with Extra floor tiles is recommended.



WADV5001*
WADVN001**
○ 710 l m²
matt



WADV5002*
WADVN002**
○ 710 l m²
matt

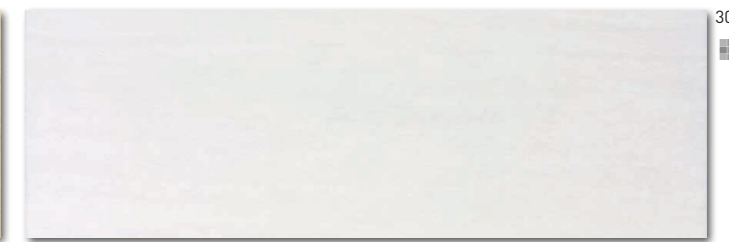

WADV5003*
WADVN003**
○ 710 l m²
matt

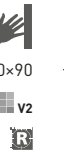

30x90

v2

R



WADVK001
○ 480 l m²
matt



WADVK002
○ 480 l m²
matt



WADVK003
○ 480 l m²
matt

30x60

v2

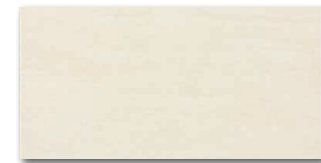

WADMB001
○ 400 l m²
matt



WADMB002
○ 400 l m²
matt
beige | beige

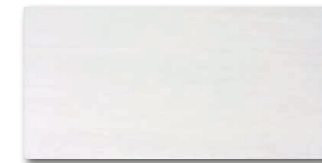

WADMB003
○ 400 l m²
matt
hellgrau | light grey

20x40

v2

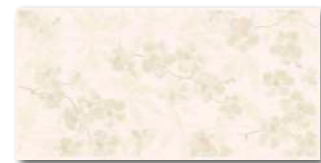

WITMB054
○ 220 l St
matt | V3

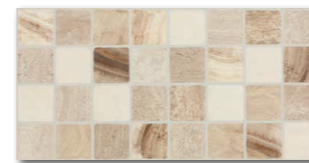

WADMB004
○ 440 l m²
relief matt | V4
mehrfarbig | multicoloured

20x40



WLAMF022
○ 160 l St
matt
hellbeige | light beige



WLAMF023
○ 160 l St
matt
beige | beige

3,2x40

Produkt | product



Produkt product	cm	mm	EN	mm	kg/m ²	kg	kg	kg	kg	kg	kg
Wandfliese wall tile	30-90	298-898-10	EN 14411 - L BIII	4	3,7	1,08	30	32,40	20,0	18,5	625
Wandfliese wall tile**	30x90	298x898x8	EN 14411 - L BIII	5	3,7	1,35	30	40,50	20,0	14,8	625
Wandfliese wall tile	20-40	198-398-7	EN 14411 - L BIII	20	12,5	1,60	48	76,80	20,6	12,9	1 016
Dekor decor (WITMB...)	20-40	198-398-7	EN 14411 - L BIII	4	12,5	0,32	-	-	4,1	12,9	-
Bordüre listel	40x3,2	398-32x7	EN 14411 - L BIII	12	-	0,14	-	-	-	-	-

* Verfügbar solange der Vorrat reicht | Available while stocks last

** Neues Produkt in 8 mm Stärke im Laufe des Jahres 2025 verfügbar | New product in 8 mm thickness available during 2025

Wir empfehlen die Kombination mit den Fliesen der Serie Bricola, Pino, Plank und Concept. | To combine with Bricola, Pino, Plank und Concept floor tiles is recommended.

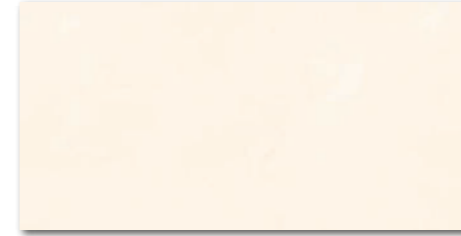

WADV590
 ○ 480 | m²
 matt | **V3**
 hellbeige | light beige

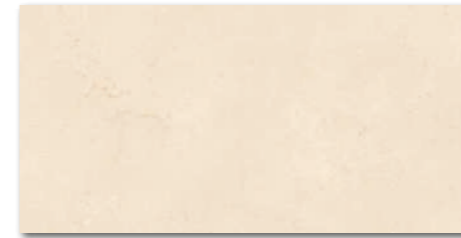

WADV591
 ○ 480 | m²
 matt | **V3**
 beige | beige



WADV592
 ○ 480 | m²
 mattglossy | **V4**

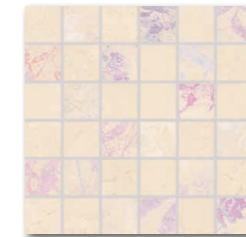

WDM05592 (SHEET)
 ○ 250 | Netz
 mattglossy



WADMB590
 ○ 400 | m²
 matt | **V3**
 hellbeige | light beige

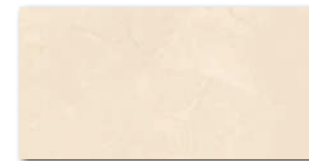

WADMB591
 ○ 400 | m²
 matt | **V3**
 beige | beige

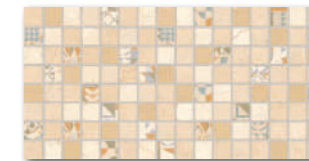

WARMB593
 ○ 440 | m²
 relief matt | **V4**
 mehrfarbig | multicoloured

5x5 | 30x30



RAKO Home

20x40

Produkt | product



Produkt product	cm	mm	EN	mm	St/m ²	kg/m ²	kg	kg	kg	kg	kg	kg
Wandfliese wall tile	30x60	298x598x8	EN 14411 - L BIII	8	5,56	1,44	40	57,60	21,3	14,8	876	
Wandfliese wall tile	20x40	198x398x7	EN 14411 - L BIII	20	12,5	1,60	48	76,80	20,6	12,9	1 016	
Mosaik set 30x30 cm mosaic sheet 30x30 cm	5x5	48x48x8	STD No. 030 - 059826	4	11	0,36	-	-	5,2	14,8	-	

Die Produktverpackung enthält zufällige Designmöglichkeiten. | The products are deliberately mixed in packing to include a random selection of designs.



Produkt product	cm	mm	EN	St/m²	kg/m²	kg	kg	kg	kg	kg	kg
Bodenfliese floor tile*	60×60	598×598×10	EN 14411 - G Bla	3	2,8	1,08	32	34,56	23,7	21,9	782
Bodenfliese floor tile**	60×60	598×598×9	EN 14411 - G Bla	4	2,8	1,44	32	46,08	29,1	20,2	955
Mosaik set 30×30 cm mosaic sheet 30×30 cm*	5×5	48×48×10	EN 14411 - G Bla	3	11	0,27	-	-	5,9	-	-
Mosaik 30×30 cm mosaic sheet 30×30 cm**	5×5	48×48×9	EN 14411 - G Bla	3	11	0,27	-	-	5,2	-	-
Stufe step tile*	60×60	598×597×10	EN 14411 - G Bla	6	5,6	1,08	-	-	23,7	-	-
Stufe step tile**	60×60	598×597×9	EN 14411 - G Bla	3	2,8	1,08	-	-	21,9	-	-
Sockel skirting plinth*	60×9,5	598×95×10	EN 14411 - G Bla	13	17,5	0,74	-	-	16,2	-	-
Sockel skirting plinth**	60×7,2	598×72×9	EN 14411 - G Bla	14	23,1	0,60	-	-	11,5	-	-

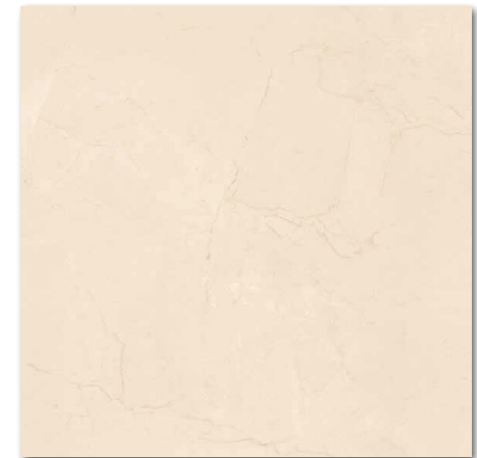
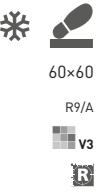

DAK63591*
DAK62591**
 PEI 4 ○ 560 | m²
 matt



DDM06591* (SHEET)
DDM05591**
 PEI 4 ○ 300 | Netz
 matt

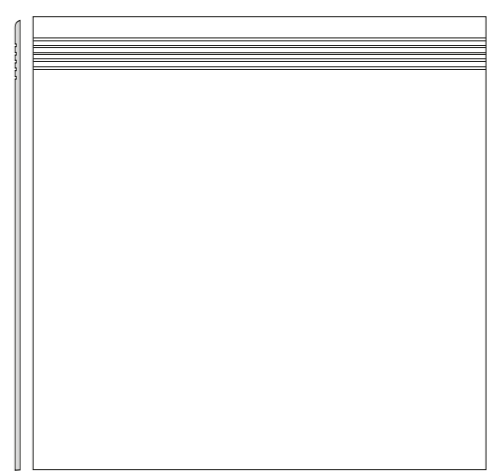

DCP63591*
DCP62591**
 PEI 4 ○ 370 | St
 matt

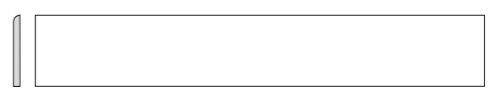

DSAS4591*
DSAS3591**
 ○ 180 | St
 matt
 beige | beige

* Verfügbar solange der Vorrat reicht | Available while stocks last

** Neues Produkt in 9 mm Stärke im Laufe des Jahres 2025 verfügbar | New product in 9 mm thickness available during 2025

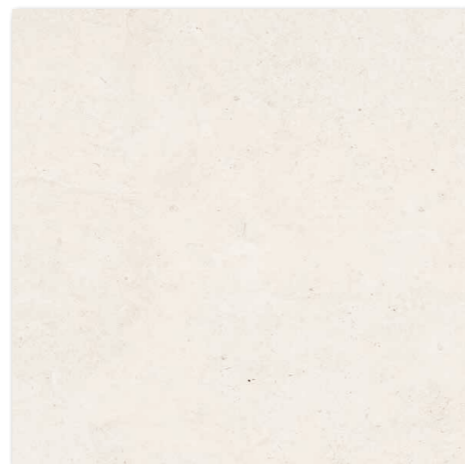

DAK63800*
DAK62800**
PEI 5 ○ 560 l m²
matt | R9/A

DAL63800*
DAL62800**
PEI 4 ○ 710 l m²
full lappato

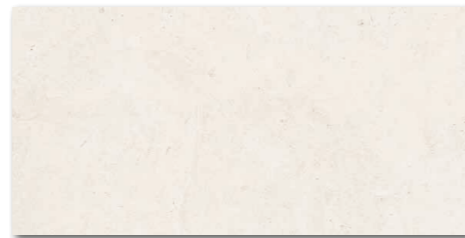

DAKSE800*
DAKSR800**
PEI 5 ○ 540 l m²
matt | R9/A

DALSE800*
DALSR800**
PEI 4 ○ 690 l m²
full lappato

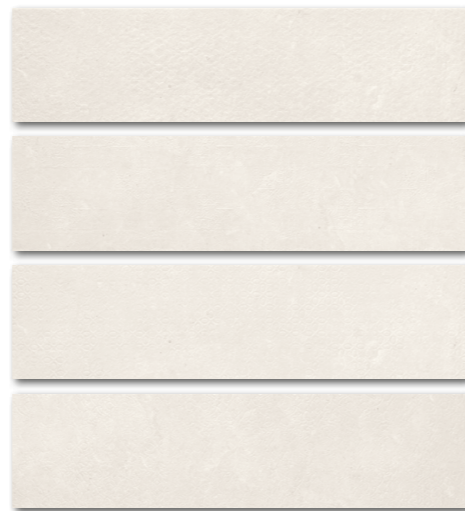

DARSU800*
DARSX800**
PEI 5 ○ 560 l m²
relief matt
elfenbein | ivory



DAK63801*
DAK62801**
PEI 5 ○ 560 l m²
matt | R9/A

DAL63801*
DAL62801**
PEI 4 ○ 710 l m²
full lappato

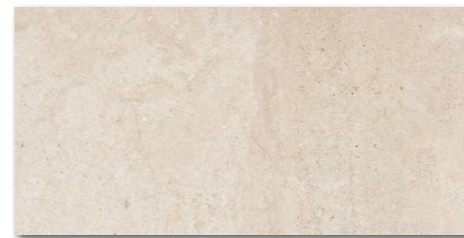

DAKSE801*
DAKSR801**
PEI 5 ○ 540 l m²
matt | R9/A

DALSE801*
DALSR801**
PEI 4 ○ 690 l m²
full lappato

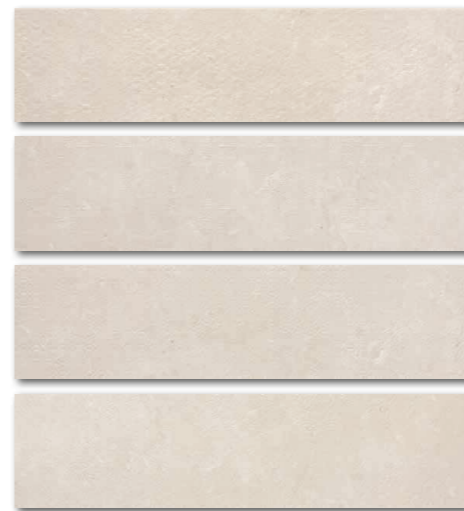

DARSU801*
DARSX801**
PEI 5 ○ 560 l m²
relief matt
beige | beige



DAK63802*
DAK62802**
PEI 4 ○ 560 l m²
matt | R9/A

DAL63802*
DAL62802**
PEI 3 ○ 710 l m²
full lappato



DAKSE802*
DAKSR802**
PEI 4 ○ 540 l m²
matt | R9/A

DALSE802*
DALSR802**
PEI 3 ○ 690 l m²
full lappato

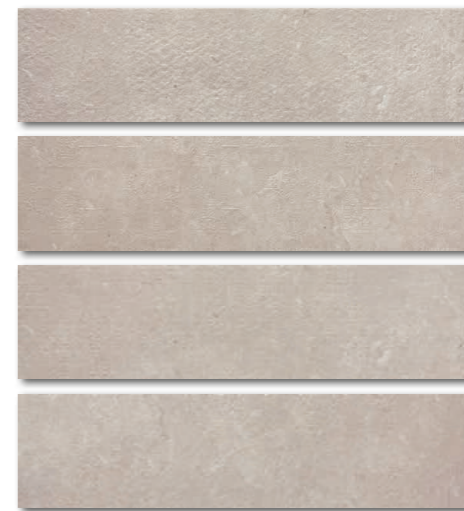

DARSU802*
DARSX802**
PEI 4 ○ 560 l m²
relief matt
beige-grau | beige-grey



60x60
v3
R



30x60
v3
R



15x60
R10/A
v4
R

Produkt product	cm	mm	EN	Stk/m ²	Stk/m ²	Stk/m ²	Stk/m ²	Stk/m ²	Stk/m ²	kg/m ²	Stk/m ²
Bodenfliese floor tile*	60x60	598-598x10	EN 14411 - G Bla	3	2,8	1,08	32	34,56	23,7	21,9	782
Bodenfliese floor tile**	60x60	598-598x9	EN 14411 - G Bla	4	2,8	1,44	32	46,08	29,1	20,2	955
Bodenfliese floor tile*	30x60	298-598x10	EN 14411 - G Bla	6	5,6	1,08	40	43,20	23,7	21,9	971
Bodenfliese floor tile**	30x60	298-598x9	EN 14411 - G Bla	7	5,6	1,26	40	50,40	24,2	19,2	993
Bodenfliese floor tile*	15x60	148-598x10	EN 14411 - G Bla	10	11,1	0,90	-	-	19,7	-	-
Bodenfliese floor tile**	15x60	148-598x9	EN 14411 - G Bla	11	11,1	0,99	-	-	19,0	-	-

* Verfügbar solange der Vorrat reicht | Available while stocks last

** Neues Produkt in 9 mm Stärke im Laufe des Jahres 2025 verfügbar | New product in 9 mm thickness available during 2025

Die Produktverpackung enthält zufällige Designmöglichkeiten. | The products are deliberately mixed in packing to include a random selection of designs.

Empfohlene Formatkombinationen siehe Seite 522-523. | Recommended combinations of modular sizes see pages 522-523.



Die Fliesen der Serie zeichnen sich durch ein breites Farbspiel V3 aus. | All products of the entire batch show big deviations in shade difference V3.

Wir empfehlen, einzelne Fliesen aus mehreren Paketen herauszunehmen und den gesamten Bodenbelag nach der Inspirationsfotodokumentation in den Katalogen RAKO, eventuell den Webseiten www.rako.eu, zu komponieren. Wünschenswert ist die Kombination aller Fliesendesigns einschließlich ihrer Drehung um 90° oder 180°, sodass ausgewogene Optik der verlegten Fläche erzielt wird.

Before laying the tiles, we suggest you select from several cartons and arrange them as illustrated in the inspiration photo documentation in RAKO catalogues or website www.rako.eu, and mix the tiles to achieve the required result including turning them by 90° or 180°.

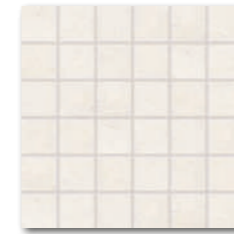

DDM06800* (SHEET)
DDM05800**
 PEI 5 \odot 300 | Netz
 relief mattfull lappato
 elfenbein | ivory



DDM06801* (SHEET)
DDM05801**
 PEI 5 \odot 300 | Netz
 relief mattfull lappato
 beige | beige



DDM06802* (SHEET)
DDM05802**
 PEI 4 \odot 300 | Netz
 relief mattfull lappato
 beige-grau | beige-grey

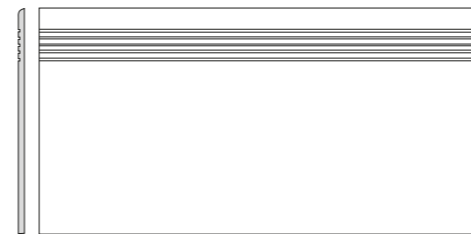

DCPSE800* | **DCPSR800**** elfenbein | ivory
 DCPSE801* | **DCPSR801**** beige | beige
 DCPSE802* | **DCPSR802**** beige-grau | beige-grey
 PEI 4-5 \odot 270 | St
 matt



DSAS4800* | **DSAS3800**** elfenbein | ivory
 DSAS4801* | **DSAS3801**** beige | beige
 DSAS4802* | **DSAS3802**** beige-grau | beige-grey
 \odot 180 | St
 matt



Produkt product	cm	mm	EN	St/m ²	kg/m ²	kg	kg	kg	kg	kg/m ²	kg/m ²
Mosaik set 30x30 cm mosaic sheet 30x30 cm*	5x5	48x48x10	EN 14411 - G Bla	3	11	0,27	-	-	5,9	-	-
Mosaik 30x30 cm mosaic sheet 30x30 cm**	5x5	48x48x9	EN 14411 - G Bla	3	11	0,27	-	-	5,2	-	-
Stufe step tile*	30x60	298x598x10	EN 14411 - G Bla	6	5,6	1,08	-	-	23,7	-	-
Stufe step tile**	30x60	298x598x9	EN 14411 - G Bla	5	5,6	0,90	-	-	17,3	-	-
Sockel skirting plinth*	60x9,5	598x95x10	EN 14411 - G Bla	13	17,5	0,74	-	-	16,2	-	-
Sockel skirting plinth**	60x7,2	598x72x9	EN 14411 - G Bla	14	23,1	0,60	-	-	11,5	-	-

* Verfügbar solange der Vorrat reicht | Available while stocks last

** Neues Produkt in 9 mm Stärke im Laufe des Jahres 2025 verfügbar | New product in 9 mm thickness available during 2025



Maxim Velčovský (1976)

Maxim Velčovský absolvierte die Akademie für Kunst, Architektur und Design Prag im Porzellan und Keramikdesignatelier. Im Jahr 2002 hat er mit Jakub Berdych das Qubus Designstudio gegründet, ab 2011 arbeitet er als Leiter des Ateliers der Keramik und Porzellan an der Akademie für Kunst, Architektur und Design Prag und als Kreativleiter der Gesellschaft Lasvit. Seine Werke befinden sich in den Sammlungen des Victoria & Albert Museums in London, Centre Pompidou in Paris, Mudac Lausanne, Neue Sammlung in München, Kunstgewerbemuseum in Prag und in der Mährischen Galerie in Brunn. Sein Portfolio enthält Konzepte für private Galerien, ebenso wie Werke für transnationale Korporationen. Das Werk von Maxim Velčovský wurde bei Marcus Fairs in die Publikation Twenty-First Century Design eingefügt. Im Jahr 2006 ist Maxim Velčovský als der erste Tschechische Designer auf der Titelseite der britischen Zeitschrift Icon erschienen und im Jahr wurde er in der Publikation & fork unter 100 der interessantesten jungen Produktdesigners der letzten fünf Jahren gewählt. Im Jahr 2007 wurde er bei der Akademie Czech Grand Design zum Designer des Jahres gewählt und im Jahr 2008 hat seine Installation für die Gesellschaft Lobmeyr von der Zeitschrift Wallpaper Wallpaper die Schätzung Auftrag des Jahres bekommen.

Maxim Velčovský (1976)

Maxim Velčovský studied the Academy of Arts, Architecture & Design in Prague in the Ceramics and Porcelain Studio. In 2002, together with Jakub Berdych, he established Qubus design studio, since 2011 Maxim Velčovský also work as the Head of the Ceramics and Porcelain Studio at the Academy of Arts, Architecture & Design and as a creative director of the company Lasvit. His works are in the collections of the Victoria & Albert Museum in London, Centre Pompidou in Paris, Mudac Lausanne, Neue Sammlung in Munich, Museum of Decorative Arts in Prague and the Moravian Gallery in Brno. His portfolio includes some concepts for private galleries, as well as some works for multinational corporations. The work of Maxim Velčovský was included by Marcus Fairs into the publication Twenty-First Century Design. In 2006, Maxim Velčovský became the first Czech designer to feature the front cover of the British magazine Icon and in 2007, he was chosen in the publication & fork among the 100 most interesting young product designers of the last five years. In 2007, the Academy Czech Grand Design named him the Designer of the Year and in 2008, his installation for the company Lobmeyr got the award for the project of the year from the magazine Wallpaper.





60x60

R10/B

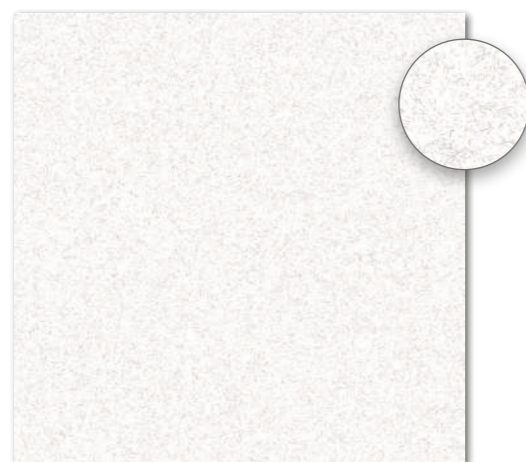

DAK63820
PEI 5 \odot 680 l m²
matt | **V2**
weiß | white



DAK63821
PEI 5 \odot 680 l m²
matt | **V2**
grau | grey



DAK63822
PEI 4 \odot 680 l m²
matt | **V2**
schwarz | black

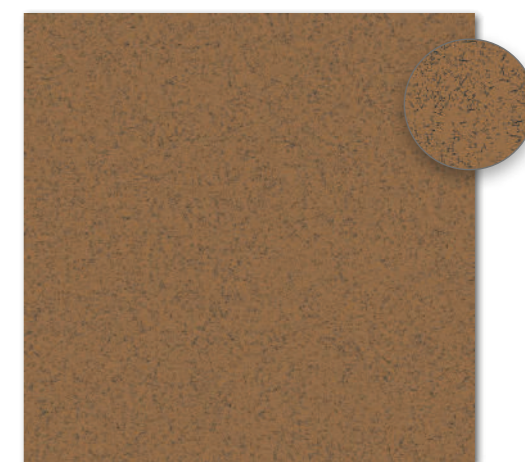

DAK63823
PEI 4 \odot 680 l m²
matt | **V2**
braun | brown



DAK63824
PEI 5 \odot 680 l m²
matt | **V3**
weiß-grau | white-grey

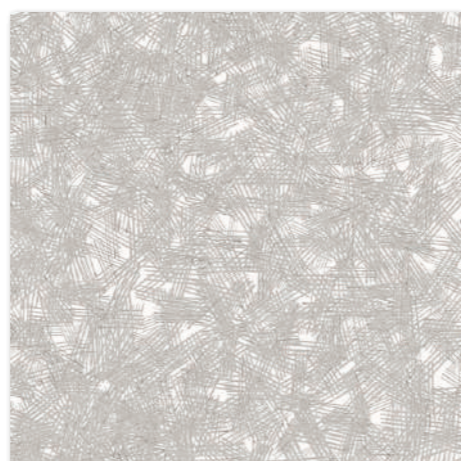

DAK63825
PEI 5 \odot 680 l m²
matt | **V3**
weiß-grau | white-grey



DAK63826
PEI 4 \odot 680 l m²
matt | **V3**
braun-schwarz | brown-black



DAK63827
PEI 4 \odot 680 l m²
matt | **V3**
braun-schwarz | brown-black

20x20

R10/B

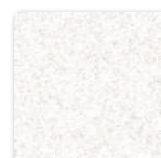

DAK26820
PEI 5 \odot 780 l m²
matt | **V2**
weiß | white



DAK26824
PEI 5 \odot 780 l m²
matt | **V3**
weiß-grau | white-grey



DAK26821
PEI 5 \odot 780 l m²
matt | **V2**
grau | grey

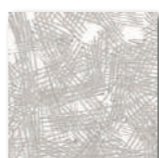

DAK26825
PEI 5 \odot 780 l m²
matt | **V3**
weiß-grau | white-grey



DAK26822
PEI 4 \odot 780 l m²
matt | **V2**
schwarz | black

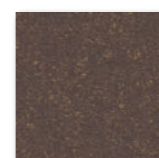

DAK26826
PEI 4 \odot 780 l m²
matt | **V3**
braun-schwarz | brown-black

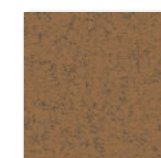

DAK26823
PEI 4 \odot 780 l m²
matt | **V2**
braun | brown

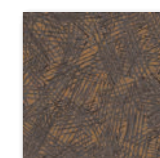

DAK26827
PEI 4 \odot 780 l m²
matt | **V3**
braun-schwarz | brown-black

Produkt | product



Produkt product	cm	mm	EN	St/m ²	kg/m ²	kg/m ²	kg/m ²	kg/m ²	kg/m ²	kg/m ²	kg/m ²
Bodenfliese floor tile	60x60	598x598x10	EN 14411 - G Bla	3	2,8	1,08	32	34,56	23,7	21,9	782
Bodenfliese floor tile	20x20	197x197x10	EN 14411 - G Bla	23	25	0,92	57	52,44	20,1	21,9	1 174
Stufe step tile	30x60	298x598x10	EN 14411 - G Bla	6	5,6	1,08	-	-	23,7	21,9	-
Sockel skirting plinth	60x9,5	598x95x10	EN 14411 - G Bla	13	17,5	0,74	-	-	16,2	21,9	-



60x60

R10/B

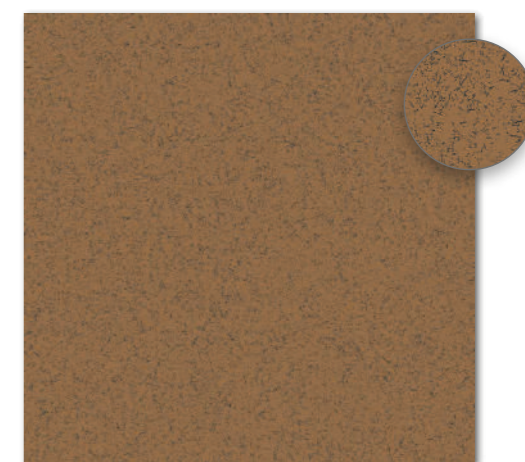

DAK63823
PEI 4 \odot 680 l m²
matt | **V2**
braun | brown



DAK63826
PEI 4 \odot 680 l m²
matt | **V3**
braun-schwarz | brown-black

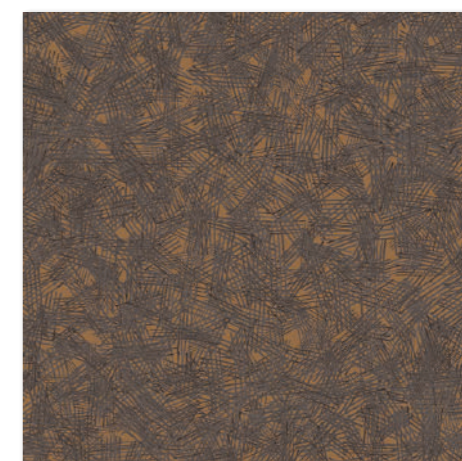

DAK63827
PEI 4 \odot 680 l m²
matt | **V3**
braun-schwarz | brown-black



DAK26822
PEI 4 \odot 780 l m²
matt | **V2**
schwarz | black



DAK26826
PEI 4 \odot 780 l m²
matt | **V3**
braun-schwarz | brown-black

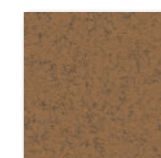

DAK26823
PEI 4 \odot 780 l m²
matt | **V2**
braun | brown

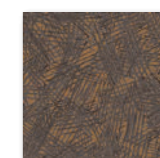

DAK26827
PEI 4 \odot 780 l m²
matt | **V3**
braun-schwarz | brown-black

20x20

R10/B



30x60

R10/B



60x9,5



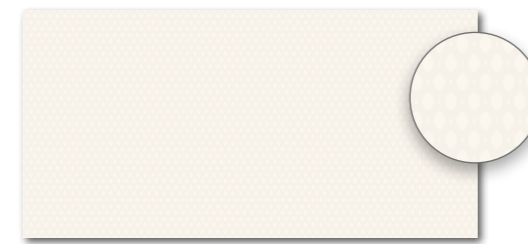

WADV4675*
WADV675
○ 480 l m²
mattglossy | ■ V2
elfenbein | ivory



WDM06675* (SHEET)
WDM05675
○ 250 l Netz
mattglossy | > | ■ V2 | ■



WADV4676*
WADV676
○ 480 l m²
mattglossy | ■ V4
blau | blue



WDM06676* (SHEET)
WDM05676
○ 250 l Netz
mattglossy | > | ■ V4 | ■



WADV4678*
WADV678
○ 480 l m²
mattglossy | ■ V4
grün | green



WDM06678* (SHEET)
WDM05678
○ 250 l Netz
mattglossy | > | ■ V4 | ■



30×60
5×5 | 30×30
DryFix

Produkt | product



Produkt product	cm	mm	EN	kg	Stm ²	kg	kg	kg	kg	kg	kg
Wandfliese wall tile*	30×60	298×598×10	EN 14411 - L BIII	6	5,56	1,08	40	43,20	20,0	18,5	825
Wandfliese wall tile	30×60	298×598×8	EN 14411 - L BIII	8	5,56	1,44	40	57,60	21,3	14,8	876
Mosaik set 30×30 cm mosaic sheet 30×30 cm	5×5	48×48×10	STO No. 030 - 059826	3	11	0,27	-	-	4,7	18,5	-
Mosaik set 30×30 cm mosaic sheet 30×30 cm	5×5	48×48×8	STO No. 030 - 059826	4	11	0,36	-	-	5,2	14,8	-

* Verfügbar solange der Vorrat reicht | Available while stocks last

ⓘ Die Produktverpackung enthält zufällige Designmöglichkeiten. | The products are deliberately mixed in packing to include a random selection of designs.

Wir empfehlen die Kombination mit den Fliesen der Serien Bricola, Pino und Saloon. | To combine with Bricola, Pino and Saloon floor tiles is recommended.

20x25
v2



WAAGX105
300 l m²
matt

WAAGX103
300 l m²
glossy

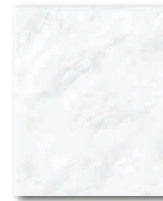

WAAGX106
300 l m²
matt

WAAGX104
300 l m²
glossy



WITGX113
150 l St
glossy



WITGX110
150 l St
glossy

20x6,1



WLAED115
110 l St
matt
beige | beige

WLAED113
120 l St
glossy



WLAED114
110 l St
matt
grau | grey

WLAED110
120 l St
glossy

20x60
v3

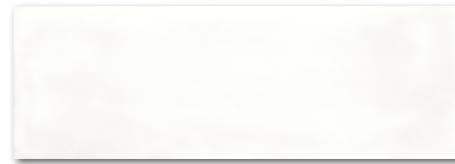

WARVE043
510 l m²
relief glossy
weiß | white

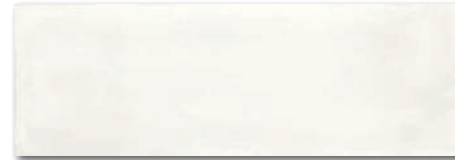

WARVE044
510 l m²
relief glossy
hellgrau | light grey

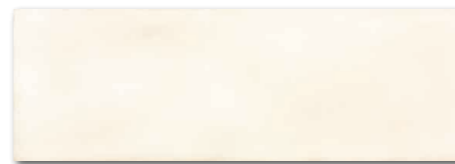

WARVE045
510 l m²
relief glossy
hellbeige | light beige



WARVE143
510 l m²
relief glossy

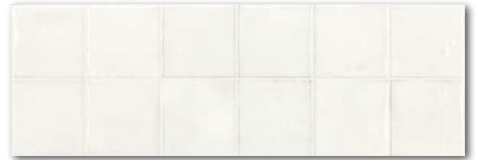

WARVE144
510 l m²
relief glossy

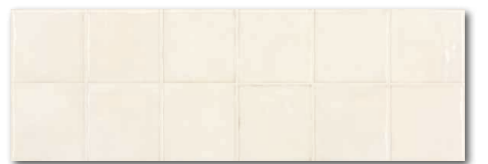

WARVE145
510 l m²
relief glossy



WARVE147
710 l m²
relief glossy
grau | grey



WARVE148
710 l m²
relief glossy
beige | beige



WARVE146
710 l m²
relief glossy
blau | blue



WLAVH008
350 l St
glossy
mehrfarbig | multicoloured



WLASZ009
350 l St
glossy
mehrfarbig | multicoloured

Produkt product	mm	mm	EN	St/m ²	St/m ²	St/m ²	St/m ²	St/m ²	kg/m ²	brutto kg	
Wandfliese wall tile	20x25	198x248x6,8	EN 14411 - L BIII	30	20	1,50	60	90,00	17,6	11,7	1 078
Dekor decor	20x25	198x248x6,8	EN 14411 - L BIII	4	20	0,20	-	-	2,3	11,7	-
Bordüre listel	20x6,1	198x61x6,8	EN 14411 - L BIII	18	82	0,22	-	-	2,5	11,5	-
Wandfliese wall tile	20x60	198x598x10	EN 14411 - L BIII	9	8,3	1,08	42	45,36	20,0	18,5	865
Dekor decor	20x60	198x598x10	EN 14411 - L BIII	3	8,3	0,72	-	-	13,3	18,5	-
Bordüre listel	60x3,5	598x35x10	EN 14411 - L BIII	6	47,6	0,13	-	-	2,7	18,5	-
Bordüre listel	60x6	598x60x10	EN 14411 - L BIII	6	27,8	0,22	-	-	4,1	18,5	-

Die Produktverpackung enthält zufällige Designmöglichkeiten. | The products are deliberately mixed in packing to include a random selection of designs.

Wir empfehlen die Kombination mit den Fliesen der Serie Pino, Saloon und Via. | To combine with Pino, Saloon and Via floor tiles is recommended.



30×60
v2



WARVK560
○ 480 l m²
relief matt

10×30
v2

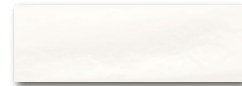

GARJD560
○ 650 l m²
relief glossy
weiß | white

30×60
v2

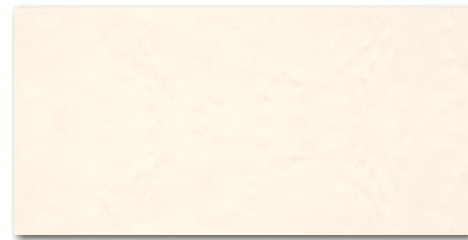

WARVK561
○ 480 l m²
relief matt
hellbeige | light beige

10×30
v2

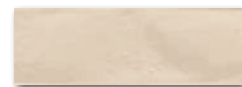

GARJD561
○ 670 l m²
relief glossy
beige | beige

30×60
v2

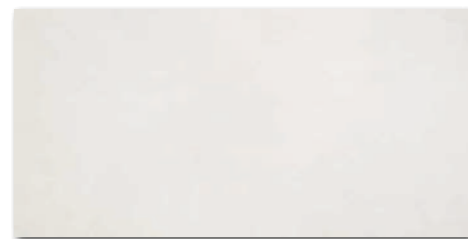

WARVK562
○ 480 l m²
relief matt
hellgrau | light grey

10×30
v2



GARJD562
○ 670 l m²
relief glossy
grau | grey



25×33
v2



WATKB178
○ 350 l m²
matt

WATKB177
○ 350 l m²
glossy



WATKB180
○ 350 l m²
matt

WATKB179
○ 350 l m²
glossy

20×25
v2



WATG6039
○ 300 l m²
matt

WATG6038
○ 300 l m²
glossy

beige | beige



WATG6041
○ 300 l m²
matt

WATG6040
○ 300 l m²
glossy

grau | grey

Wir empfehlen die Kombination mit den Fliesen der Serien Bricola, Pino, Plank and Base. | To combine with Bricola, Pino, Plank and Base floor tiles is recommended.

Produkt product												
Wandfliese wall tile	30×60	298-598-8	EN 14411 - L BIII	8	5,56	1,44	40	57,60	21,3	14,8	876	
Dekor decor	10×30	98-298-8	EN 14411 - H BIIb	24	33,3	0,72	66	47,52	12,5	17,3	851	
Wandfliese wall tile	20×25	198-248-6,8	EN 14411 - L BIII	30	20	1,50	60	90,00	17,6	11,7	1 078	
Wandfliese wall tile	25×33	250-330-7	EN 14411 - L BIII	18	12	1,50	54	81,00	18,6	12,4	1 030	



Daniel Pirsc is a leading Czech designer in the field of porcelain. Mr. Pirsc finished his studies at the Academy of Arts, Architecture and Design in ceramics and porcelain. Since 2005, he has his own studio called PIRSC PORCELAIN in Mikulov, Czech Republic. At the same time, he is the head of the Ceramics and Porcelain Studio at the Academy of Fine Arts and Design in Bratislava.

He participates in prestigious exhibitions and presentations of modern design in the Czech Republic and abroad.

In his art-design work, Mr. Pirsc tries to find new uses of porcelain as a luxurious material not only for dining but also for interior decor, interior architecture and objects for a more demanding clientele. Quality, production methods, innovative technology and exceptional design make Mr. Pirsc a true master of his craft on the domestic market as well as on foreign markets.

Daniel Pirsc ist einer der führenden tschechischen Designer im Bereich Porzellan. Pirsc studierte im Atelier für Keramik und Porzellan an der Akademie für Kunst, Architektur und Design in Prag. Seit 2005 betreibt er sein eigenes Studio PIRSC PORCELAIN im tschechischen Mikulov. Gleichzeitig leitet er auch das Atelier für Keramik und Porzellan an der Hochschule für Angewandte Kunst in Bratislava.

National und international ist Daniel Pirsc regelmäßig ein wichtiger Bestandteil von renommierten Ausstellungen und Präsentationen für modernes Design.

In seinem Art-Design-Konzept sucht Pirsc nach neuen Verwendungsmöglichkeiten für Keramik als Luxusmaterial, nicht nur für die Gastronomie, sondern auch für die Inneneinrichtung, Innenarchitektur und Objekte für eine anspruchsvolle Kundschaft. Beste Qualität, neuste Produktionsprozesse, innovative Technologien und einzigartiges Design machen Daniel Pirsc zu einem Meister seines Handwerks sowohl auf dem tschechischen als auch auf dem internationalen Markt.



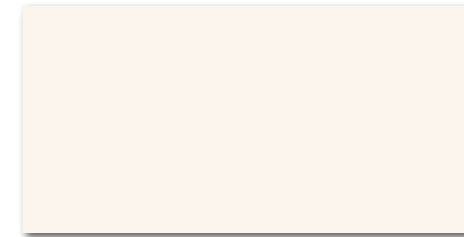
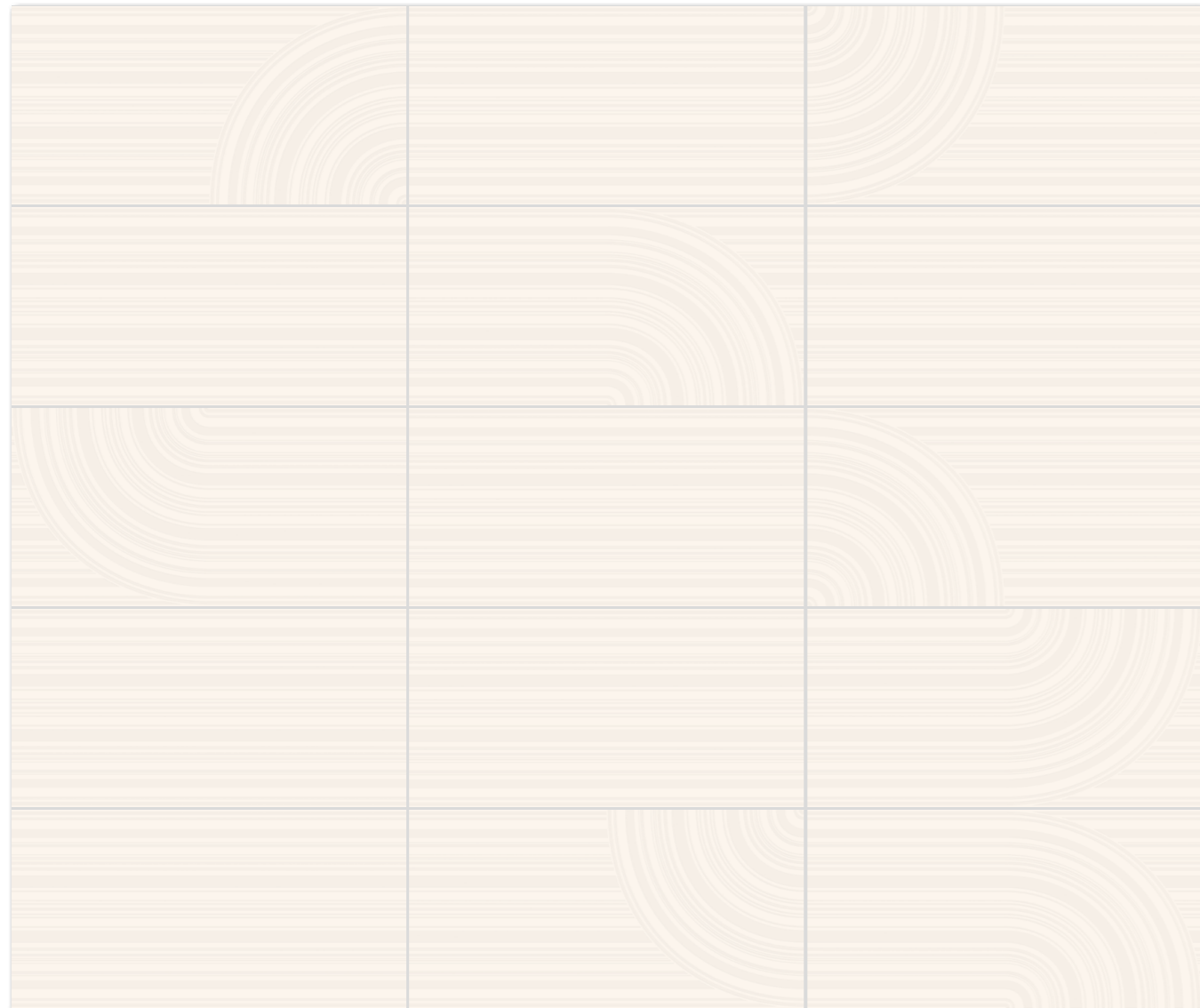

WAKVK652
 ○ 500 l m²
 matt | V1
 elfenbein | ivory

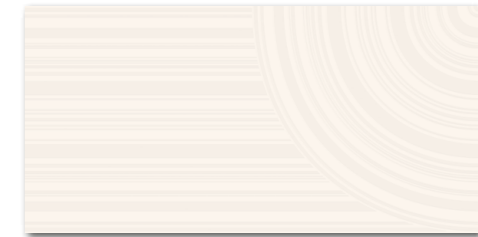

WAKVK650
 ○ 500 l m²
 mattglossy | V2
 elfenbein | ivory



WAKVK651
 ○ 500 l m²
 mattglossy | V2
 schwarz | black



Die Fliesen der Serie zeichnen sich durch ein breites Farbspiel V1 | V2 aus. | All products of the entire batch show deviations in shade difference V1 | V2.

Wir empfehlen, einzelne Fliesen aus mehreren Paketen herauszunehmen und den gesamten Bodenbelag nach der Inspirationsfotodokumentation in den Katalogen RAKO, eventuell den Webseiten www.rako.eu, zu komponieren. Wünschenswert ist die Kombination aller Fliesendesigns einschließlich ihrer Drehung um 180°, sodass ausgewogene Optik der verlegten Fläche erzielt wird.

Before laying the tiles, we suggest you select from several cartons and arrange them as illustrated in the inspiration photo documentation in RAKO catalogues or website www.rako.eu, and mix the tiles to achieve the required result including turning them by 180°.



ⓘ Die Produktverpackung enthält zufällige Designmöglichkeiten. | The products are deliberately mixed in packing to include a random selection of designs.

Wir empfehlen die Kombination mit den Fliesen der Serie Rebel. | To combine with Rebel floor tiles is recommended.

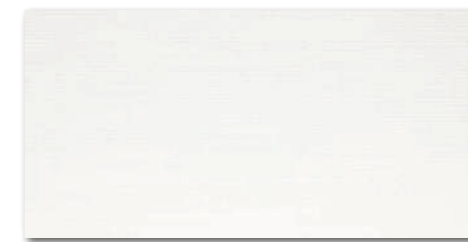

WARVK500
○ 500 l m²
relief matt



WARVK501
○ 500 l m²
relief matt

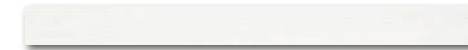

WLAVP500
○ 220 l St
relief matt



WLAVP501
○ 220 l St
relief matt



WDM05500 (SHEET)
○ 250 l Netz
relief matt
hellgrau | light grey



WDM05501 (SHEET)
○ 250 l Netz
relief matt
grau | grey



WARVK502
○ 500 l m²
relief matt

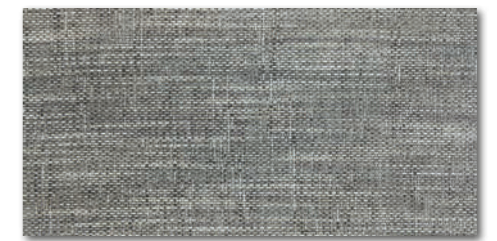

WARVK502
○ 500 l m²
relief matt



WLAVP502
○ 220 l St
relief matt

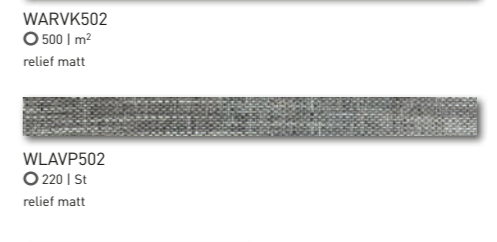

WLAVP502
○ 220 l St
relief matt



WARVK503
○ 500 l m²
relief matt | **V4** | **R**
grau | grey

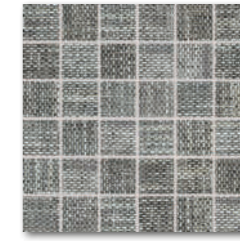

WDM05502 (SHEET)
○ 250 l Netz
relief matt
dunkelgrau | dark grey

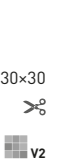
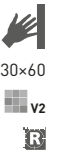

RAKO Home

Produkt product	cm	mm	EN	St/m ²	kg/m ²	kg/m ²	kg/m ²	kg/m ²	kg/m ²	kg/m ²	kg/m ²
Wandfliese wall tile	30x60	298x598x8	EN 14411 - L BIII	8	5,56	1,44	40	57,60	21,3	14,8	876
Bordüre listel	60x5	598x48x10	EN 14411 - L BIII	11	33,3	0,33	-	-	6,1	18,5	-
Bordüre listel	60x5	598x48x8	EN 14411 - L BIII	14	33,3	0,42	-	-	6,1	14,8	-
Mosaik set 30x30 cm mosaic sheet 30x30 cm	5x5	48x48x8	STO No. 030 - 059826	4	11	0,36	-	-	5,2	14,8	-

Die Produktverpackung enthält zufällige Designsmöglichkeiten. | The products are deliberately mixed in packing to include a random selection of designs.

Wir empfehlen die Kombination mit den Fliesen der Serie Extra, Pino und Plank. | To combine with Extra, Pino und Plank floor tiles is recommended.

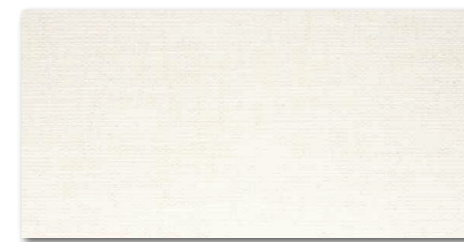

WARVK504
○ 500 l m²
relief matt



WARVK505
○ 500 l m²
relief matt



WLAVP504
○ 220 l St
relief matt



WLAVP505
○ 220 l St
relief matt



WDM05504 (SHEET)
○ 250 l Netz
relief matt
hellbeige | light beige



WDM05505 (SHEET)
○ 250 l Netz
relief matt
beige | beige

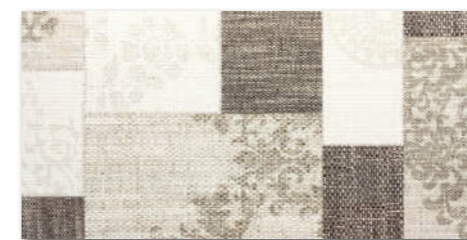

WARVK506
○ 500 l m²
relief matt



WARVK506
○ 500 l m²
relief matt



WARVK507
○ 500 l m²
relief matt | v4 | R
braun | brown

WDM05506 (SHEET)
○ 250 l Netz
relief matt
braun | brown

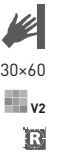

Produkt product	cm	mm	EN	St/m ²	kg/m ²	kg	kg	kg	kg	kg	
Wandfliese wall tile	30x60	298x598x8	EN 14411 - L BIII	8	5,56	1,44	40	57,60	21,3	14,8	876
Bordüre listel	60x5	598x48x10	EN 14411 - L BIII	11	33,3	0,33	-	-	6,1	18,5	-
Bordüre listel	60x5	598x48x8	EN 14411 - L BIII	14	33,3	0,42	-	-	6,1	14,8	-
Mosaik set 30x30 cm mosaic sheet 30x30 cm	5x5	48x48x8	STO No. 030 - 059826	4	11	0,36	-	-	5,2	14,8	-

Die Produktverpackung enthält zufällige Designsmöglichkeiten. | The products are deliberately mixed in packing to include a random selection of designs.

Wir empfehlen die Kombination mit den Fliesen der Serie Extra, Pino und Plank. | To combine with Extra, Pino und Plank floor tiles is recommended.

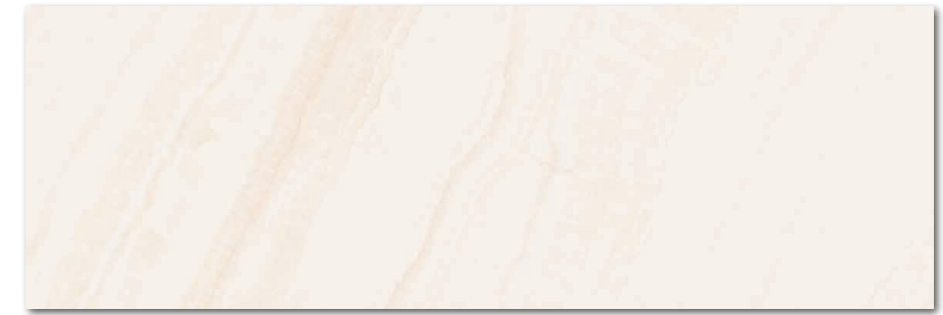
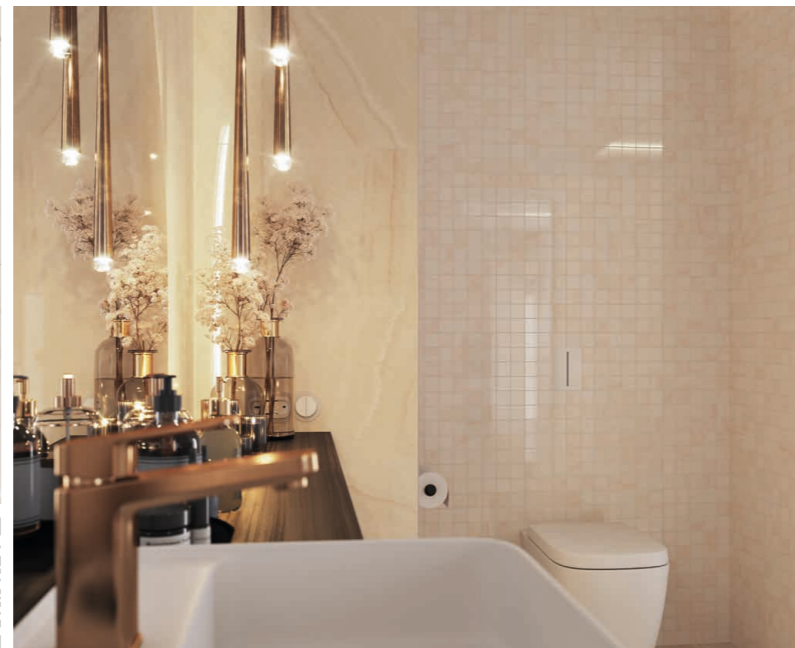

WAKV6834
 ○ 680 | m²
 glossy
 hellbeige | light beige

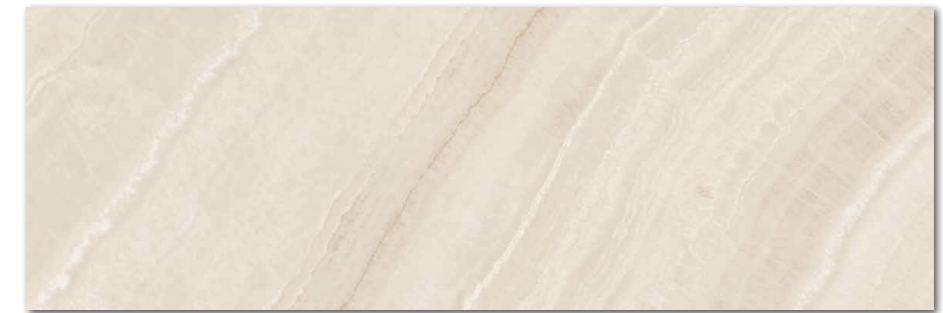

WAKV6835
 ○ 680 | m²
 glossy
 dunkelbeige | dark beige



WAKVK834
 ○ 500 | m²
 glossy
 hellbeige | light beige

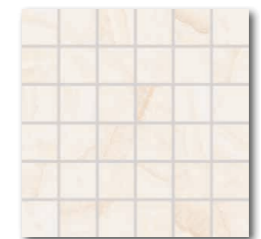

WDM05834 (SHEET)
 ○ 250 | Netz
 glossy | >=

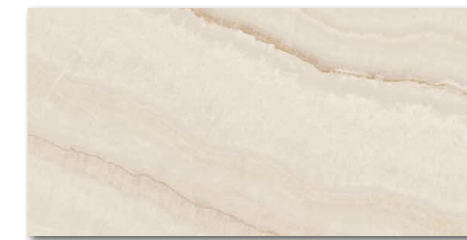

WAKVK835
 ○ 500 | m²
 glossy
 dunkelbeige | dark beige



WDM05835 (SHEET)
 ○ 250 | Netz
 glossy | >=

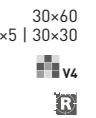

Produkt | product



Wandfliese wall tile	40×120	398×1198×10	EN 14411 - L BIII	3	2,1	1,44	21	30,24	29,0	20,1	633
Wandfliese wall tile	30×60	298×598×8	EN 14411 - L BIII	8	5,56	1,44	40	57,60	21,3	14,8	876
Mosaik set 30×30 cm mosaic sheet 30×30 cm	5×5	48×48×8	STO No. 030 - 059826	4	11	0,36	-	-	5,2	14,8	-



Die Fliesen der Serie zeichnen sich durch ein breites Farbspiel V4 aus. | All products of the entire batch show big deviations in shade difference V4.

Wir empfehlen, einzelne Fliesen aus mehreren Paketen herauszunehmen und den gesamten Bodenbelag nach der Inspirationsfotodokumentation in den Katalogen RAKO, eventuell den Webseiten www.rako.eu, zu komponieren. Wünschenswert ist die Kombination aller Fliesendesigns einschließlich ihrer Drehung um 90° oder 180°, sodass ausgewogene Optik der verlegten Fläche erzielt wird.

Before laying the tiles, we suggest you select from several cartons and arrange them as illustrated in the inspiration photo documentation in RAKO catalogues or website www.rako.eu, and mix the tiles to achieve the required result including turning them by 90° or 180°.

Produkt product	cm	mm	EN	St/m²	kg/m²	cm	kg	kg/m²	kg/m²	kg/m²	
Bodenfliese floor tile*	60x60	598x598x10	EN 14411 - G Bla	3	2,8	1,08	32	34,56	23,7	21,9	782
Bodenfliese floor tile**	60x60	598x598x9	EN 14411 - G Bla	4	2,8	1,44	32	44,08	29,1	20,2	955
Mosaik set 30x30 cm mosaic sheet 30x30 cm*	5x5	48x48x10	EN 14411 - G Bla	3	11	0,27	-	-	5,9	-	-
Mosaik 30x30 cm mosaic sheet 30x30 cm**	5x5	48x48x9	EN 14411 - G Bla	3	11	0,27	-	-	5,2	-	-
Stufe step tile*	60x60	598x597x10	EN 14411 - G Bla	3	2,8	1,08	-	-	23,7	-	-
Stufe step tile**	60x60	598x597x9	EN 14411 - G Bla	3	2,8	1,08	-	-	21,9	-	-
Stufenformteil special step tile*	60x53	598x530x10	STO No. 030 - 059824	2	-	-	-	-	-	-	-
Stufenformteil special step tile**	60x53	598x530x9	STO No. 030 - 059824	2	-	-	-	-	-	-	-
Sockel skirting plinth*	60x9,5	598x95x10	EN 14411 - G Bla	13	17,5	0,74	-	-	16,2	-	-
Sockel skirting plinth**	60x7,2	598x72x9	EN 14411 - G Bla	14	23,1	0,60	-	-	11,5	-	-



60x60
V4
R



DAK63835*
DAK62835**
PEI 5 ○ 560 | m²
matt | R9/A

DAL63835*
DAL62835**
PEI 4 ○ 840 | m²
full lappato



5x5 | 30x30
V4
R

DDM06835*
DDM05835**
PEI 5 ○ 300 | Netz
matt | R10/B

DDL06835*
DDL05835**
PEI 4 ○ 440 | Netz
full lappato

(SHEET)

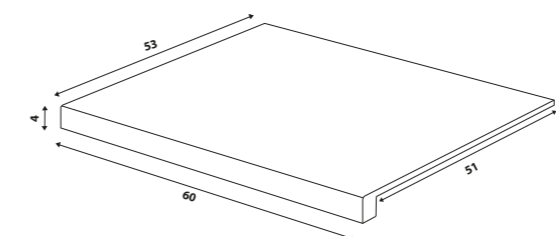

DCF65835*
DCF64835**
PEI 5 ○ 900 | St
matt | R9/A

DCG65835*
DCG64835**
PEI 4 ○ 900 | St
full lappato



60x53
60x60
V4
R

DCP63835*
DCP62835**
PEI 4 ○ 370 | St
matt | R9/A



60x9,5*
60x7,2**
R

DSAS4835*
DSAS3835**
○ 180 | St
matt

DSKS4835*
DSKS3835**
○ 270 | St
full lappato

dunkelbeige | dark beige

* Verfügbar solange der Vorrat reicht | Available while stocks last

** Neues Produkt in 9 mm Stärke im Laufe des Jahres 2025 verfügbar | New product in 9 mm thickness available during 2025



WARVK260
 ○ 500 l m²
 relief matt
 hellbeige | light beige



WARVK261
 ○ 500 l m²
 relief matt
 hellgrau | light grey



WARVK266
 ○ 500 l m²
 relief matt
 beige | beige



WARVK267
 ○ 500 l m²
 relief matt
 grau | grey



WARVK262
 ○ 500 l m²
 relief matt
 braun | brown

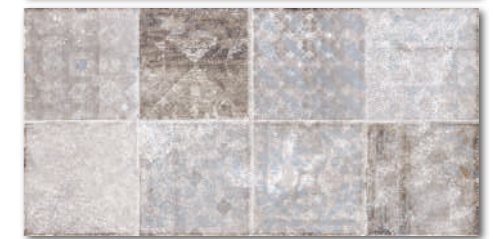
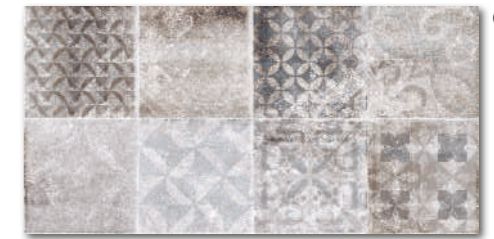

WARVK263
 ○ 500 l m²
 relief matt
 grau | grey

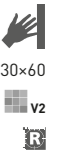

Produkt | product



kg/m²



Wandfliese | wall tile

30×60

298-598×8

EN 14411 - L BIII

8

5,56

1,44

40

57,60

21,3

14,8

876

Die Produktverpackung enthält zufällige Designsmöglichkeiten. | The products are deliberately mixed in packing to include a random selection of designs.



60x60
R10/B
v3
R



DAK63786*
DAK62786**
○ 560 l m²
matt



DAK63787*
DAK62787**
○ 560 l m²
matt



DAK63788*
DAK62788**
○ 560 l m²
matt



DAK63789*
DAK62789**
○ 560 l m²
matt



60x60
R10/B
v3
R

30x60
R10/B
v3
R



DAKSE786*
DAKSR786**
○ 540 l m²
matt



DAKSE787*
DAKSR787**
○ 540 l m²
matt

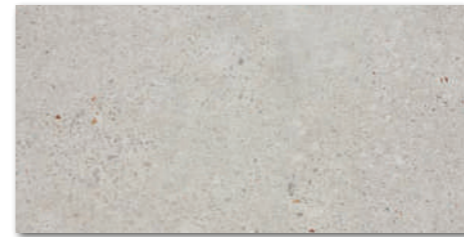

DAKSE788*
DAKSR788**
○ 540 l m²
matt

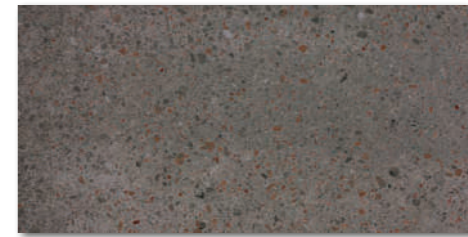

DAKSE789*
DAKSR789**
○ 540 l m²
matt

30x60
R10/B
v3
R

45x45
R10/B
v3



DAA4H786
○ 510 l m²
matt
elfenbein | ivory



DAA4H787
○ 510 l m²
matt
beige | beige



DAA4H788
○ 510 l m²
matt
hellgrau | light grey



DAA4H789
○ 510 l m²
matt
schwarz | black

45x45
R10/B
v3

Produkt product	cm	mm	EN	Stk/m ²	Stk/m ²	Stk/m ²	Stk/m ²	Stk/m ²	Stk/m ²	kg/m ²	brutto kg
Bodenfliese floor tile*	60x60	598x598x10	EN 14411 - G Bla	3	2,8	1,08	32	34,56	23,7	21,9	782
Bodenfliese floor tile**	60x60	598x598x9	EN 14411 - G Bla	4	2,8	1,44	32	46,08	29,1	20,2	955
Bodenfliese floor tile*	30x60	298x598x10	EN 14411 - G Bla	6	5,6	1,08	40	43,20	23,7	21,9	971
Bodenfliese floor tile**	30x60	298x598x9	EN 14411 - G Bla	7	5,6	1,26	40	50,40	24,2	19,2	993
Bodenfliese floor tile	45x45	448x448x8	EN 14411 - G Bla	6	5	1,21	34	41,14	21,1	17,4	741

* Verfügbar solange der Vorrat reicht | Available while stocks last

**** Neues Produkt in 9 mm Stärke im Laufe des Jahres 2025 verfügbar | New product in 9 mm thickness available during 2025**

Empfohlene Formatkombinationen siehe Seite 522-523. | Recommended combinations of modular sizes see pages 522-523.



Die Fliesen der Serie zeichnen sich durch ein breites Farbspiel V3 aus. | All products of the entire batch show big deviations in shade difference V3.

Wir empfehlen, einzelne Fliesen aus mehreren Paketen herauszunehmen und den gesamten Bodenbelag nach der Inspirationsfotodokumentation in den Katalogen RAKO, eventuell den Webseiten www.rako.eu, zu komponieren. Wünschenswert ist die Kombination aller Fliesendesigns einschließlich ihrer Drehung um 90° oder 180°, sodass ausgewogene Optik der verlegten Fläche erzielt wird.

Before laying the tiles, we suggest you select from several cartons and arrange them as illustrated in the inspiration photo documentation in RAKO catalogues or website www.rako.eu, and mix the tiles to achieve the required result including turning them by 90° or 180°.

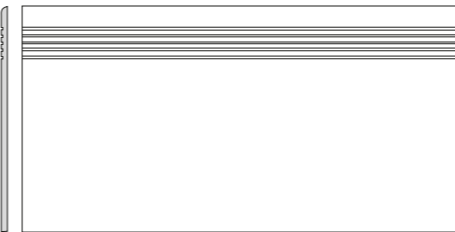
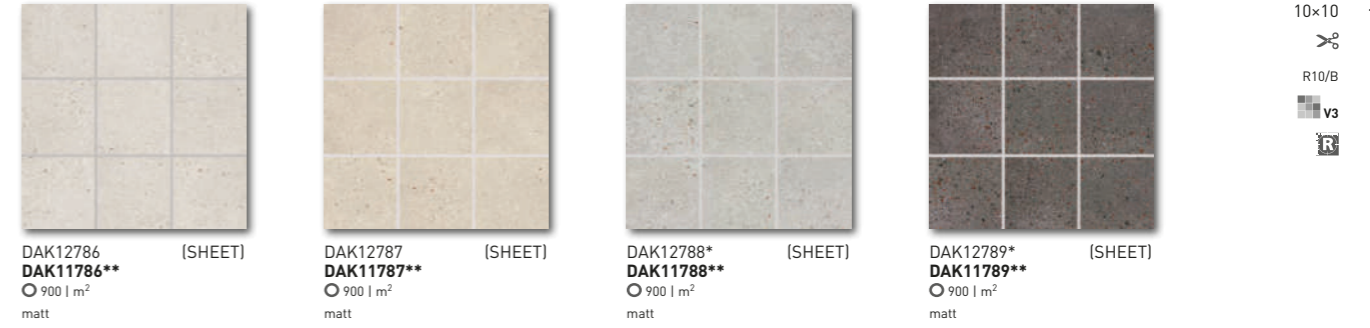

DCPSE786* | **DCPSR786**** elfenbein | ivory
DCPSE787* | **DCPSR787**** beige | beige
DCPSE788* | **DCPSR788**** hellgrau | light grey
DCPSE789* | **DCPSR789**** schwarz | black
 ○ 270 l St
 matt



DSAS4786* | **DSAS3786**** elfenbein | ivory
DSAS4787* | **DSAS3787**** beige | beige
DSAS4788* | **DSAS3788**** hellgrau | light grey
DSAS4789* | **DSAS3789**** schwarz | black
 ○ 180 l St
 matt



DSAPS786 elfenbein | ivory
DSAPS787 beige | beige
DSAPS788 hellgrau | light grey
DSAPS789 schwarz | black
 ○ 160 l St
 matt

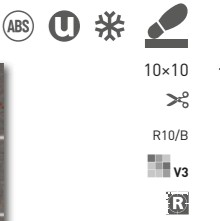

Produkt product	cm	mm	EN	St/m ²	kg/m ²	St/Netz	kg/Netz	kg/m ²	St/Netz	kg/Netz	
Bodenfliese floor tile*	10x10	98x98x10	EN 14411 - G Bla	10	11	0,91	56	50,96	19,9	21,9	1 142
Bodenfliese floor tile**	10x10	98x98x9	EN 14411 - G Bla	11	11	1,00	56	56,00	19,2	19,2	1 125
Mosaik set 30x30 cm mosaic sheet 30x30 cm*	5x5	48x48x10	EN 14411 - G Bla	3	11	0,27	-	-	5,9	-	-
Mosaik 30x30 cm mosaic sheet 30x30 cm**	5x5	48x48x9	EN 14411 - G Bla	3	11	0,27	-	-	5,2	-	-
Stufe step tile*	30x60	298x598x10	EN 14411 - G Bla	6	5,6	1,08	-	-	23,7	-	-
Stufe step tile**	30x60	298x598x9	EN 14411 - G Bla	5	5,6	0,90	-	-	17,3	-	-
Sockel skirting plinth*	60x9,5	598x95x10	EN 14411 - G Bla	13	17,5	0,74	-	-	16,2	-	-
Sockel skirting plinth**	60x7,2	598x72x9	EN 14411 - G Bla	14	23,1	0,60	-	-	11,5	-	-
Sockel skirting plinth	45x8,5	448x85x8	EN 14411 - G Bla	25	26,1	0,96	-	-	16,7	-	-

* Verfügbar solange der Vorrat reicht | Available while stocks last

** Neues Produkt in 9 mm Stärke im Laufe des Jahres 2025 verfügbar | New product in 9 mm thickness available during 2025



DAR66787
 ○ 760 l m²
 relief matt
 beige | beige



DAR66788
 ○ 760 l m²
 relief matt
 hellgrau | light grey



DAR66789
 ○ 760 l m²
 relief matt
 schwarz | black

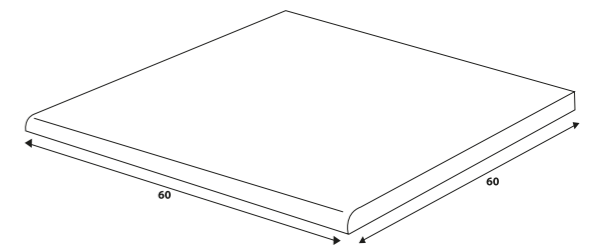

DCH66787 beige | beige
 DCH66788 hellgrau | light grey
 DCH66789 schwarz | black
 ○ 780 l St
 relief matt



60x60
 R11/B
 v3
 R
 20mm

Produkt | product

Bodenfliese | floor tile
 Stufe | step tile



60-60

60-60

EN 14411 - G Bla
 EN 14411 - G Bla

2

2,8

0,72

30

21,6

32,5

45,1

999

2

32,5





60x120

R10/B

v3



DAKV1842*
DAKV9842**
PEI 5 ○ 700 | m²
matt
color **straw**
beige | beige



DAKV1843*
DAKV9843**
PEI 4 ○ 700 | m²
matt
color **honey**
braun | brown



DAKV1845*
DAKV9845**
PEI 4 ○ 700 | m²
matt
color **doppio**
mehrfarbig | multicoloured



DAKVG842*
DAKVE842**
PEI 5 ○ 820 | m²
matt
color **straw**
beige | beige



DAKVG843*
DAKVE843**
PEI 4 ○ 820 | m²
matt
color **honey**
braun | brown



60x120
20x120

R10/B

v3



DAKV1841*
DAKV9841**
PEI 5 ○ 700 | m²
matt
color **latte**
weiß | white



DAKV1844*
DAKV9844**
PEI 4 ○ 700 | m²
matt
color **burn**
dunkelbraun | dark brown

i Für eine optimale Verlegung wird empfohlen, eine durchgängige Verlegerichtung beizubehalten (Vermeidung einer Drehung um 180°). | It is highly advised to maintain consistent directional laying (avoiding rotation by 180°) for optimal installation.



DAKVG841*
DAKVE841**
PEI 5 ○ 820 | m²
matt
color **latte**
weiß | white



DAKVG844*
DAKVE844**
PEI 4 ○ 820 | m²
matt
color **burn**
dunkelbraun | dark brown

* Verfügbar solange der Vorrat reicht | Available while stocks last

** Neues Produkt in 9 mm Stärke im Laufe des Jahres 2025 verfügbar | New product in 9 mm thickness available during 2025



30x120
R10/B
v3
R

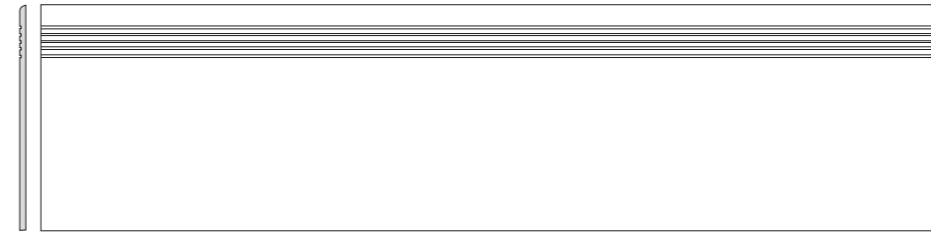

DCPVF841* | DCPVD841** color **latte** | weiß | white
 DCPVF842* | DCPVD842** color **straw** | beige | beige
 DCPVF843* | DCPVD843** color **honey** | braun | brown
 DCPVF844* | DCPVD844** color **burn** | dunkelbraun | dark brown
 PEI 4-5 ○ 740 | St
 matt



DSASP841* | DSAS3841** color **latte** | weiß | white
 DSASP842* | DSAS3842** color **straw** | beige | beige
 DSASP843* | DSAS3843** color **honey** | braun | brown
 DSASP844* | DSAS3844** color **burn** | dunkelbraun | dark brown
 ○ 180 | St
 matt

60x7,2
R

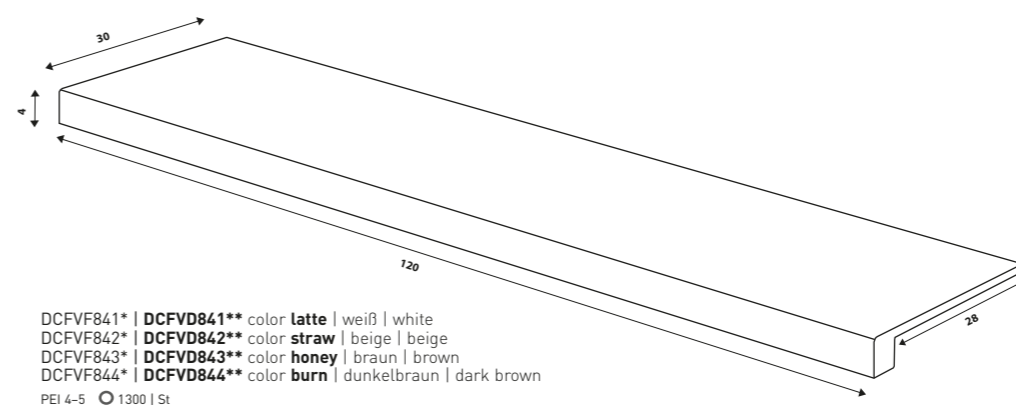

DCFVF841* | DCFVD841** color **latte** | weiß | white
 DCFVF842* | DCFVD842** color **straw** | beige | beige
 DCFVF843* | DCFVD843** color **honey** | braun | brown
 DCFVF844* | DCFVD844** color **burn** | dunkelbraun | dark brown
 PEI 4-5 ○ 1300 | St
 matt

30x120
R10/B
v3
R

* Verfügbar solange der Vorrat reicht | Available while stocks last

** Neues Produkt in 9 mm Stärke im Laufe des Jahres 2025 verfügbar | New product in 9 mm thickness available during 2025

Produkt product	cm	mm	EN	St/m ²	m ² /kg	kg/m ²	brutto kg
Bodenfliese floor tile*	60x120	598x1198x10	EN 14411 - G Bla	2	1,4	1,44	27
Bodenfliese floor tile**	60x120	598x1198x9	EN 14411 - G Bla	2	1,4	1,44	30
Bodenfliese floor tile*	20x120	198x1198x10	EN 14411 - G Bla	4	4,2	0,96	32
Bodenfliese floor tile**	20x120	198x1198x9	EN 14411 - G Bla	4	4,2	0,96	32
Stufe step tile*	30x120	298x1198x10	EN 14411 - G Bla	3	2,8	1,08	-
Stufe step tile**	30x120	298x1198x9	EN 14411 - G Bla	3	2,8	1,08	-
Sockel skirting plinth*	60x7,2	598x72x10	EN 14411 - G Bla	13	23,2	0,56	-
Sockel skirting plinth**	60x7,2	598x72x9	EN 14411 - G Bla	14	23,1	0,60	-
Stufenformteil special step tile*	30x120	298x1198x10	STO No. 030 - 059824	2	-	-	-
Stufenformteil special step tile**	30x120	298x1198x9	STO No. 030 - 059824	2	-	-	-



Produkt | product

Wandfliese | wall tile



30x60



298x598x8



EN 14411 - L BIII



8



5,56



1,44



40



57,60



21,3



14,8



87,6



30x60
v3

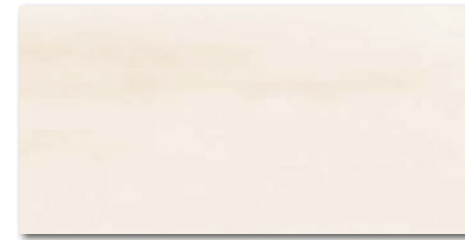

WADV573
○ 480 l m²
glossy

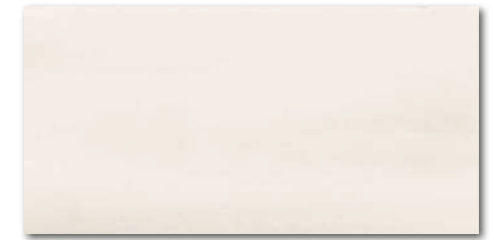

WADV575
○ 480 l m²
glossy



WADV577
○ 480 l m²
glossy
hellbeige | light beige



WADV578
○ 480 l m²
glossy
hellgrau | light grey

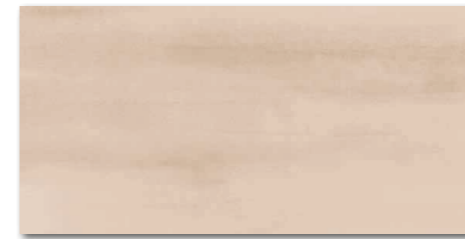

WADV574
○ 480 l m²
glossy
beige | beige

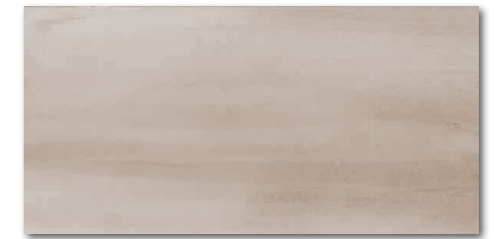

WADV576
○ 480 l m²
glossy
grau-braun | grey-brown

RAKO Home

Die Produktverpackung enthält zufällige Designmöglichkeiten. | This product is deliberately mixed in packing to include a random selection of designs.

Wir empfehlen die Kombination mit den Fliesen der Serie Blend und Extra. | To combine with Blend and Extra floor tiles is recommended.





60x120
R10/B
v3
R



DASV1810*
DASV9810**
PEI 5 ○ 700 l m²
mattlglossy
weiß | white

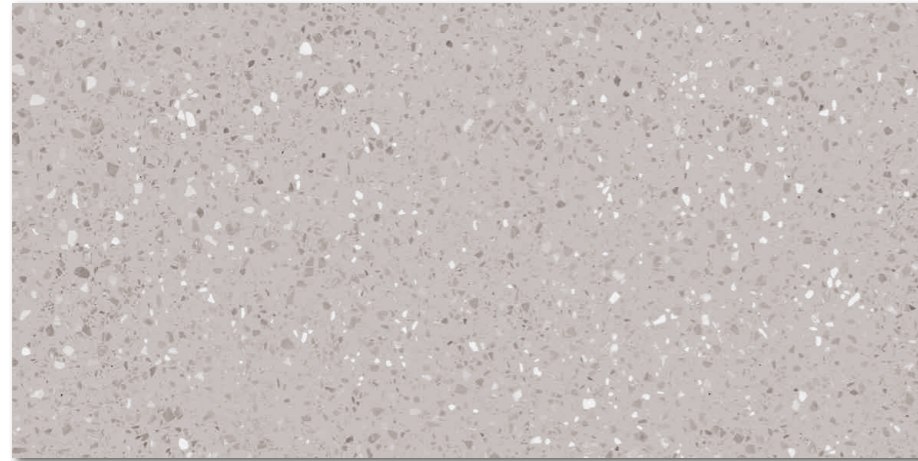

DASV1811*
DASV9811**
PEI 4 ○ 700 l m²
mattlglossy
grau | grey

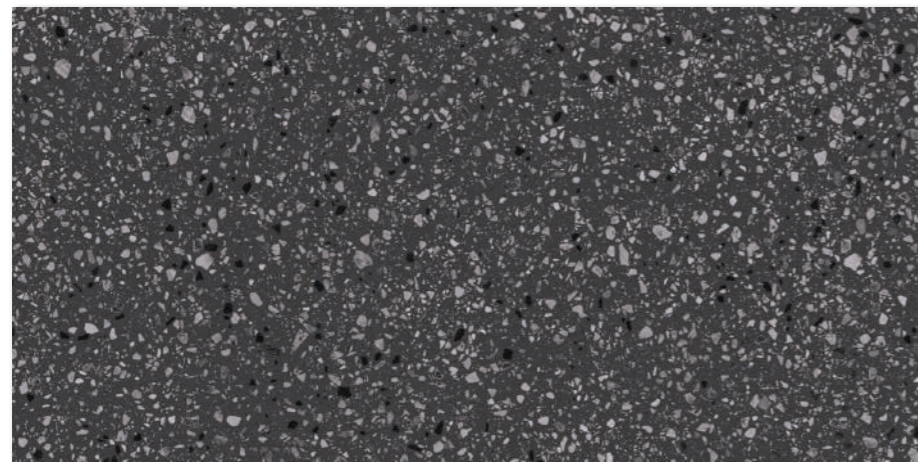

DASV1812*
DASV9812**
PEI 4 ○ 700 l m²
mattlglossy
schwarz | black



60x120
R10/B
v3
R

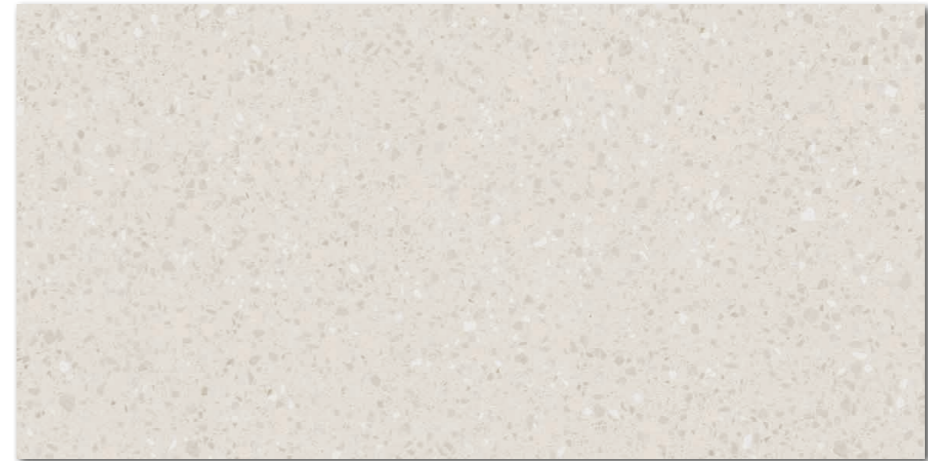

DASV1813*
DASV9813**
PEI 5 ○ 700 l m²
mattlglossy
beige | beige

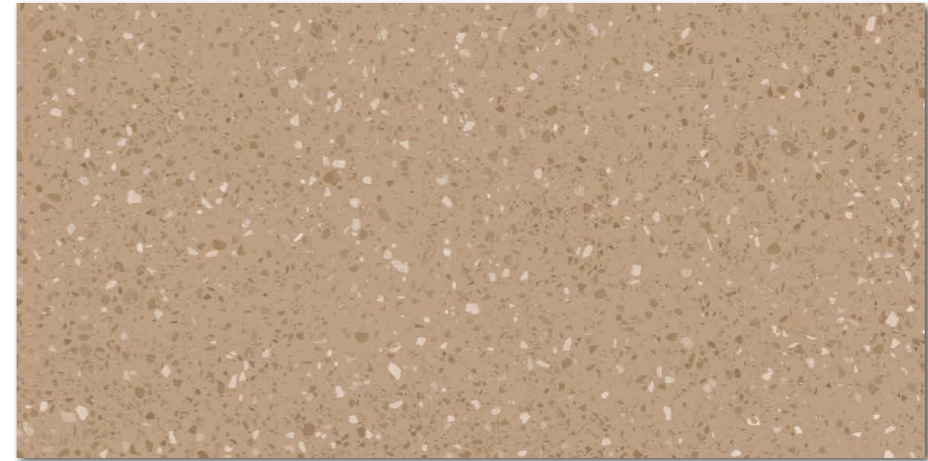

DASV1814*
DASV9814**
PEI 4 ○ 700 l m²
mattlglossy
ocker | ochre

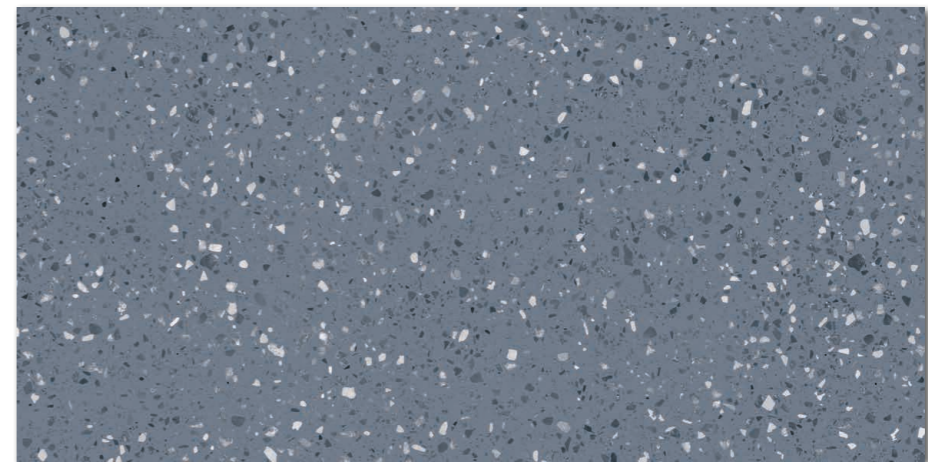

DASV1815*
DASV9815**
PEI 4 ○ 700 l m²
mattlglossy
blau | blue

Produkt | product

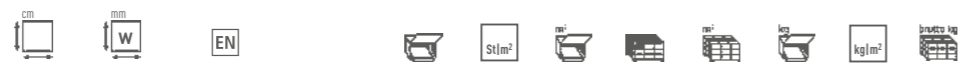

Produkt product	60x120	598x1198x10	EN 14411 - G Bla	2	1,4	1,44	27	38,88	32,7	22,7	908
Bodenfliese floor tile*	60x120	598x1198x10	EN 14411 - G Bla	2	1,4	1,44	27	38,88	32,7	22,7	908
Bodenfliese floor tile**	60x120	598x1198x9	EN 14411 - G Bla	2	1,4	1,44	30	43,20	29,3	20,4	905

* Verfügbar solange der Vorrat reicht | Available while stocks last

** Neues Produkt in 9 mm Stärke im Laufe des Jahres 2025 verfügbar | New product in 9 mm thickness available during 2025



60x60
R10/B
V3
R



DAS63810*
DAS62810**
PEI 5 ○ 560 l m²
mattlglossy
weiß | white

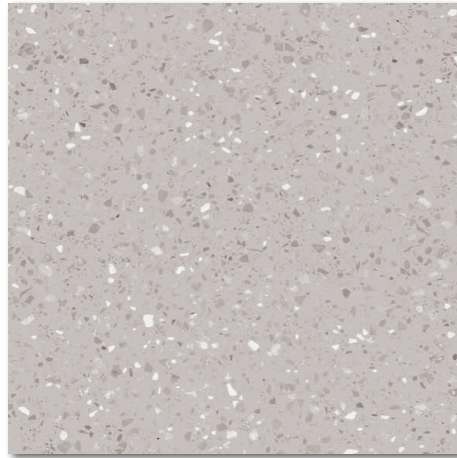

DAS63811*
DAS62811**
PEI 4 ○ 560 l m²
mattlglossy
grau | greys

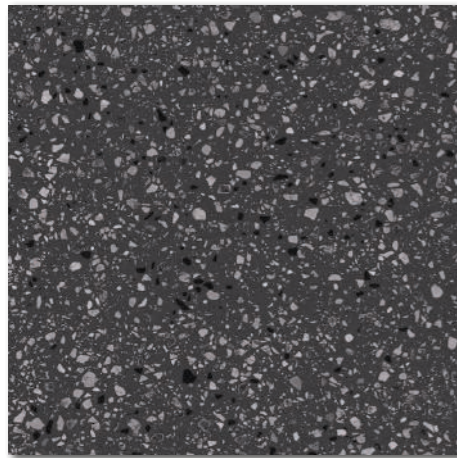

DAS63812*
DAS62812**
PEI 4 ○ 560 l m²
mattlglossy
schwarz | black



DAS63813*
DAS62813**
PEI 5 ○ 560 l m²
mattlglossy
beige | beige

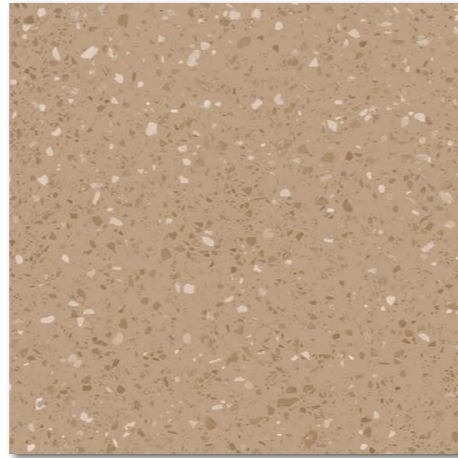

DAS63814*
DAS62814**
PEI 4 ○ 560 l m²
mattlglossy
ocker | ochre

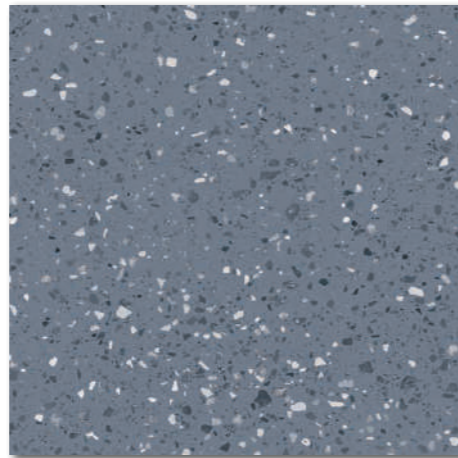

DAS63815*
DAS62815**
PEI 4 ○ 560 l m²
mattlglossy
blau | blue



20x20
R10/B
V3
R



DAS26810*
DAS25810**
PEI 5 ○ 780 l m²
mattlglossy
weiß | white

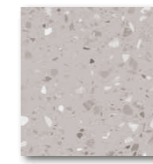

DAS26811*
DAS25811**
PEI 4 ○ 780 l m²
mattlglossy
grau | grey

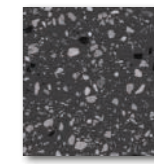

DAS26812*
DAS25812**
PEI 4 ○ 780 l m²
mattlglossy
schwarz | black



DAS26813*
DAS25813**
PEI 5 ○ 780 l m²
mattlglossy
beige | beige

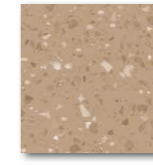

DAS26814*
DAS25814**
PEI 4 ○ 780 l m²
mattlglossy
ocker | ochre

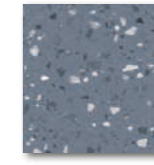

DAS26815*
DAS25815**
PEI 4 ○ 780 l m²
mattlglossy
blau | blue



DDM06810* (SHEET)
DDM05810**
PEI 5 ○ 300 l Netz
mattlglossy
weiß | white

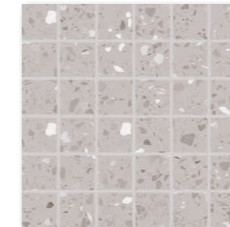

DDM06811* (SHEET)
DDM05811**
PEI 4 ○ 300 l Netz
mattlglossy
grau | grey

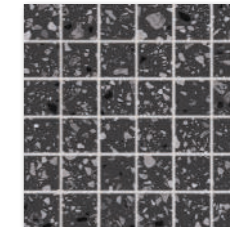

DDM06812* (SHEET)
DDM05812**
PEI 4 ○ 300 l Netz
mattlglossy
schwarz | black



DDM06813* (SHEET)
DDM05813**
PEI 5 ○ 300 l Netz
mattlglossy
beige | beige

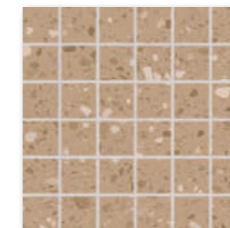

DDM06814* (SHEET)
DDM05814**
PEI 4 ○ 300 l Netz
mattlglossy
ocker | ochre

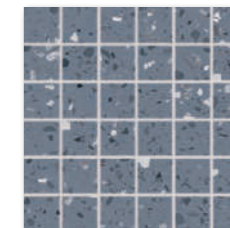

DDM06815* (SHEET)
DDM05815**
PEI 4 ○ 300 l Netz
mattlglossy
blau | blue

5x5 | 30x30
R10/B
V3
R

* Verfügbar solange der Vorrat reicht | Available while stocks last

** Neues Produkt in 9 mm Stärke im Laufe des Jahres 2025 verfügbar | New product in 9 mm thickness available during 2025

Produkt product	cm	mm	EN	Stm ²	Stm ²	Stm ²	Stm ²	Stm ²	kg/m ²	kg/m ²
Bodenfliese floor tile*	60x60	598x598x10	EN 14411 - G Bla	3	2,8	1,08	32	34,56	23,7	21,9
Bodenfliese floor tile**	60x60	598x598x9	EN 14411 - G Bla	4	2,8	1,44	32	46,08	29,1	20,2
Bodenfliese floor tile*	20x20	197x197x10	EN 14411 - G Bla	23	25	0,92	57	52,44	20,1	21,9
Bodenfliese floor tile**	20x20	197x197x9	EN 14411 - G Bla	25	25	1,00	57	57,00	19,2	19,2
Mosaik set 30x30 cm mosaic sheet 30x30 cm*	5x5	48x48x10	EN 14411 - G Bla	3	11	0,27	-	-	5,9	-
Mosaik 30x30 cm mosaic sheet 30x30 cm**	5x5	48x48x9	EN 14411 - G Bla	3	11	0,27	-	-	5,2	-



Die Fliesen der Serie zeichnen sich durch ein breites Farbspiel V3 aus. | All products of the entire batch show big deviations in shade difference V3.

Wir empfehlen, einzelne Fliesen aus mehreren Paketen herauszunehmen und den gesamten Bodenbelag nach der Inspirationsfotodokumentation in den Katalogen RAKO, eventuell den Webseiten www.rako.cz, zu komponieren. Wünschenswert ist die Kombination aller Fliesendesigns einschließlich ihrer Drehung um 90° oder 180°, sodass ausgewogene Optik der verlegten Fläche erzielt wird.

Before laying the tiles, we suggest you select from several cartons and arrange them as illustrated in the inspiration photo documentation in RAKO catalogues or website www.rako.eu, and mix the tiles to achieve the required result including turning them by 90° or 180°.

Produkt product	cm	mm	EN	St/m²	kg/m²	kg	kg/m²	kg
Stufe step tile*	30x120	298x1198x10	EN 14411 - G Bla	3	2,8	1,08	-	24,6
Stufe step tile**	30x120	298x1198x9	EN 14411 - G Bla	3	2,8	1,08	-	22,5
Stufe step tile*	30x60	298x598x10	EN 14411 - G Bla	6	5,6	1,08	-	23,7
Stufe step tile**	30x60	298x598x9	EN 14411 - G Bla	5	5,6	0,90	-	17,3
Sockel skirting plinth*	60x9,5	598x95x10	EN 14411 - G Bla	13	23,2	0,56	-	12,7
Sockel skirting plinth**	60x7,2	598x72x9	EN 14411 - G Bla	14	23,1	0,60	-	11,5
Stufenformteil special step tile*	30x120	298x1198x10	STO No. 030 - 059824	2	-	-	-	-
Stufenformteil special step tile**	30x120	298x1198x9	STO No. 030 - 059824	2	-	-	-	-



30x120
R10/B
V3
R

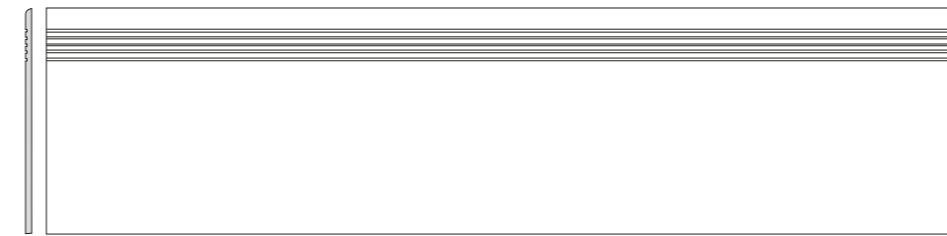

DCPVF810* | DCPVD810** weiß | white
DCPVF811* | DCPVD811** grau | grey
DCPVF812* | DCPVD812** schwarz | black
DCPVF813* | DCPVD813** beige | beige
PEI 4-5 ○ 740 | St
mattlglossy



DCPSE810* | DCPSR810** weiß | white
DCPSE811* | DCPSR811** grau | grey
DCPSE812* | DCPSR812** schwarz | black
DCPSE813* | DCPSR813** beige | beige
PEI 4-5 ○ 270 | St
mattlglossy

30x60
R10/B
V3
R



DSAS4810* | DSAS3810** weiß | white
DSAS4811* | DSAS3811** grau | grey
DSAS4812* | DSAS3812** schwarz | black
DSAS4813* | DSAS3813** beige | beige
○ 180 | St
mattlglossy

60x9,5*
60x7,2**
R

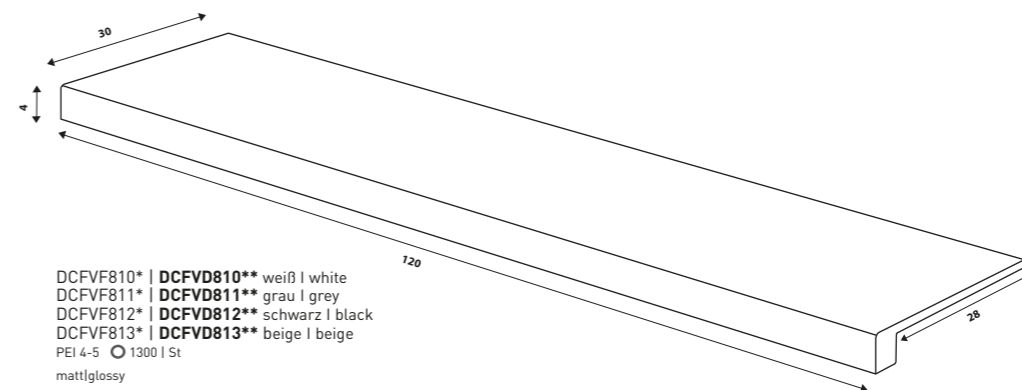

DCFVF810* | DCFVD810** weiß | white
DCFVF811* | DCFVD811** grau | grey
DCFVF812* | DCFVD812** schwarz | black
DCFVF813* | DCFVD813** beige | beige
PEI 4-5 ○ 1300 | St
mattlglossy

30x120
R10/B
V3
R

* Verfügbar solange der Vorrat reicht | Available while stocks last

** Neues Produkt in 9 mm Stärke im Laufe des Jahres 2025 verfügbar | New product in 9 mm thickness available during 2025





Die Fliesen der Serie zeichnen sich durch ein breites Farbspiel V3 aus. | All products of the entire batch show big deviations in shade difference V3.

Wir empfehlen, einzelne Fliesen aus mehreren Paketen herauszunehmen und den gesamten Bodenbelag nach der Inspirationsfotodokumentation in den Katalogen RAKO, eventuell den Webseiten www.rako.eu, zu komponieren. Wünschenswert ist die Kombination aller Fliesendesigns einschließlich ihrer Drehung um 90° oder 180°, sodass ausgewogene Optik der verlegten Fläche erzielt wird.

Before laying the tiles, we suggest you select from several cartons and arrange them as illustrated in the inspiration photo documentation in RAKO catalogues or website www.rako.eu, and mix the tiles to achieve the required result including turning them by 90° or 180°.



DAK81735
PEI 5 \odot 700 | m²
matt



DAK81736
PEI 4 \odot 700 | m²
matt



DAK84735
PEI 5 \odot 720 | m²
matt
beige | beige



DAK84736
PEI 4 \odot 720 | m²
matt
braun | brown



80x80
R9/A
V3
R

40x80
R9/A
V3
R

Produkt | product



Produkt product	cm	mm	EN	mm	kg/m ²	m ²	kg	kg	kg	kg	kg
Bodenfliese floor tile	80x80	798~798x10	EN 14411 - G Bla	2	1,6	1,28	42	53,76	28,0	21,9	1 202
Bodenfliese floor tile	40x80	398~798x10	EN 14411 - G Bla	4	3,1	1,28	42	53,76	28,0	21,9	1 202

Empfohlene Formatkombinationen siehe Seite 522-523. | Recommended combinations of modular sizes see pages 522-523.



80x80
R9/A
v3
R



DAK81737
PEI 5 ○ 700 l m²
matt



DAK81738
PEI 4 ○ 700 l m²
matt



DAK81739
PEI 4 ○ 700 l m²
matt | R9/A



DAK63739*
DAK62739**
PEI 4 ○ 560 l m²
matt | R9/A



80x80
60x60
v3
R

40x80
R9/A
v3
R



DAK84737
PEI 5 ○ 720 l m²
matt
grau | grey



DAK84738
PEI 4 ○ 720 l m²
matt
dunkelgrau | dark grey



DAK84739
PEI 4 ○ 720 l m²
matt | R9/A
schwarz | black

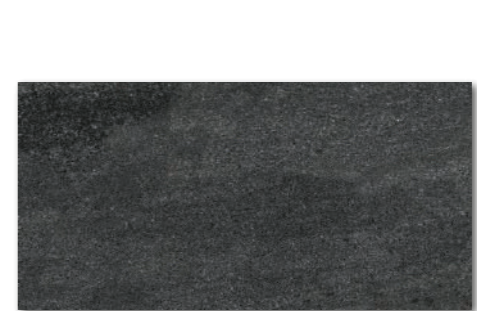

DAKSE739*
DAKSR739**
PEI 4 ○ 540 l m²
matt | R9/A

DARSE739*
DARSR739**
PEI 4 ○ 540 l m²
relief matt | R10/B

40x80
30x60
v3
R

Produkt product	cm	mm	EN	Stk/m ²	Stk/m ²	Stk/m ²	Stk/m ²	Stk/m ²	Stk/m ²	kg/m ²	Brutto kg
Bodenfliese floor tile	80x80	798x798x10	EN 14411 - G Bla	2	1,6	1,28	42	53,76	28,0	21,9	1 202
Bodenfliese floor tile	40x80	398x798x10	EN 14411 - G Bla	4	3,1	1,28	42	53,76	28,0	21,9	1 202
Bodenfliese floor tile*	60x60	598x598x10	EN 14411 - G Bla	3	2,8	1,08	32	34,56	23,7	21,9	782
Bodenfliese floor tile**	60x60	598x598x9	EN 14411 - G Bla	4	2,8	1,44	32	46,08	29,1	20,2	955
Bodenfliese floor tile*	30x60	298x598x10	EN 14411 - G Bla	6	5,6	1,08	40	43,20	23,7	21,9	971
Bodenfliese floor tile**	30x60	298x598x9	EN 14411 - G Bla	7	5,6	1,26	40	50,40	24,2	19,2	993

* Verfügbar solange der Vorrat reicht | Available while stocks last

** Neues Produkt in 9 mm Stärke im Laufe des Jahres 2025 verfügbar | New product in 9 mm thickness available during 2025

Empfohlene Formatkombinationen siehe Seite 522-523. | Recommended combinations of modular sizes see pages 522-523.



60×60
v3
R



DAK63735*
DAK62735**
PEI 5 ○ 560 l m²
matt | R9/A



DAK63736*
DAK62736**
PEI 4 ○ 560 l m²
matt | R9/A



DAK63737*
DAK62737**
PEI 5 ○ 560 l m²
matt | R9/A



DAK63738*
DAK62738**
PEI 4 ○ 560 l m²
matt | R9/A



60×60
v3
R

30×60
v3
R



DAKSE735*
DAKSR735**
PEI 5 ○ 540 l m²
matt | R9/A

DARSE735*
DARSR735**
PEI 5 ○ 540 l m²
relief matt | R10/B



DAKSE736*
DAKSR736**
PEI 4 ○ 540 l m²
matt | R9/A

braun | brown

DARSE736*
DARSR736**
PEI 4 ○ 540 l m²
relief matt | R10/B



DAKSE737*
DAKSR737**
PEI 5 ○ 540 l m²
matt | R9/A

DARSE737*
DARSR737**
PEI 5 ○ 540 l m²
relief matt | R10/B



DAKSE738*
DAKSR738**
PEI 4 ○ 540 l m²
matt | R9/A

dunkelgrau | dark grey

DARSE738*
DARSR738**
PEI 4 ○ 540 l m²
relief matt | R10/B

30×60
R



DDTSE735*
DDTSR735**
○ 490 l St
relief mattlglossy
beige | beige



DDTSE737*
DDTSR737**
○ 490 l St
relief mattlglossy
grau | grey

30×60
v3
R

30×60
R

Produkt product	cm	mm	EN	St	St/m ²	mm	mm	mm	mm	kg	kg/m ²	brutto kg
Bodenfliese floor tile*	60×60	598×598×10	EN 14411 - G Bla	3	2,8	1,08	32	34,56	23,7	21,9	782	
Bodenfliese floor tile**	60×60	598×598×9	EN 14411 - G Bla	4	2,8	1,44	32	46,08	29,1	20,2	955	
Bodenfliese floor tile*	30×60	298×598×10	EN 14411 - G Bla	6	5,6	1,08	40	43,20	23,7	21,9	971	
Bodenfliese floor tile**	30×60	298×598×9	EN 14411 - G Bla	7	5,6	1,26	40	50,40	24,2	19,2	993	
Dekor decor*	30×60	298×598×10	EN 14411 - G Bla	4	5,6	0,72	-	-	15,8	-	-	
Dekor decor**	30×60	298×598×9	EN 14411 - G Bla	5	5,6	0,90	-	-	17,3	-	-	

* Verfügbar solange der Vorrat reicht | Available while stocks last

** Neues Produkt in 9 mm Stärke im Laufe des Jahres 2025 verfügbar | New product in 9 mm thickness available during 2025

Empfohlene Formatkombinationen siehe Seite 522-523. | Recommended combinations of modular sizes see pages 522-523.

30×60
R



20x20
10x10
5x5 | 30x30

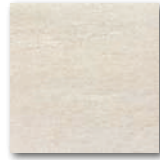

DAR26735*
DAR25735**
PEI 5 ○ 780 | m²
relief matt
beige | beige



DAR12735* (SHEET)
DAR11735**
PEI 5 ○ 900 | m²
relief matt | >⊘



DDM06735* (SHEET)
DDM05735**
PEI 5 ○ 300 | Netz
relief matt | >⊘



DAR26736*
DAR25736**
PEI 4 ○ 780 | m²
relief matt
braun | brown



DAR12736* (SHEET)
DAR11736**
PEI 4 ○ 900 | m²
relief matt | >⊘

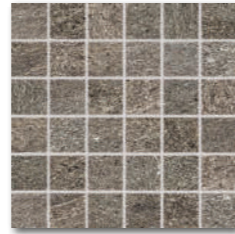

DDM06736* (SHEET)
DDM05736**
PEI 4 ○ 300 | Netz
relief matt | >⊘



DAR26737*
DAR25737**
PEI 5 ○ 780 | m²
relief matt
grau | grey



DAR12737* (SHEET)
DAR11737**
PEI 5 ○ 900 | m²
relief matt | >⊘



DDM06737* (SHEET)
DDM05737**
PEI 5 ○ 300 | Netz
relief matt | >⊘



DAR26738*
DAR25738**
PEI 4 ○ 780 | m²
relief matt
dunkelgrau | dark grey

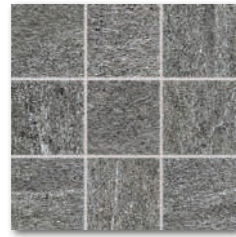

DAR12738* (SHEET)
DAR11738**
PEI 4 ○ 900 | m²
relief matt | >⊘

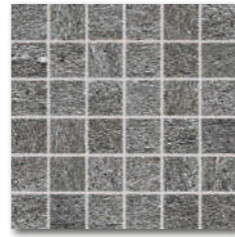

DDM06738* (SHEET)
DDM05738**
PEI 4 ○ 300 | Netz
relief matt | >⊘

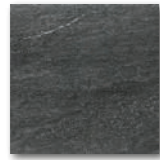

DAR26739*
DAR25739**
PEI 4 ○ 780 | m²
relief matt
schwarz | black

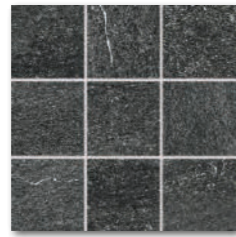

DAR12739* (SHEET)
DAR11739**
PEI 4 ○ 900 | m²
relief matt | >⊘

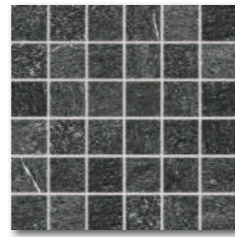

DDM06739* (SHEET)
DDM05739**
PEI 4 ○ 300 | Netz
relief matt | >⊘



40x80
30x60

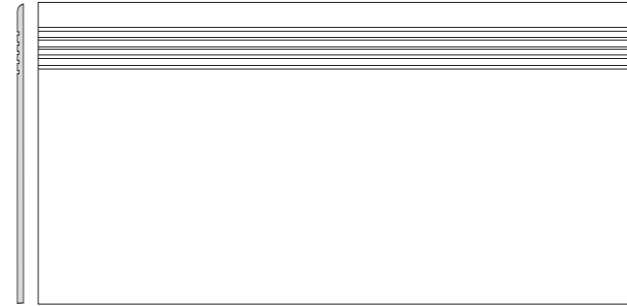

DCP84735 beige | beige
DCP84736 braun | brown
DCP84737 grau | grey
DCP84738 dunkelgrau | dark grey
DCP84739 schwarz | black
PEI 4-5 ○ 380 | St
matt | R9/A

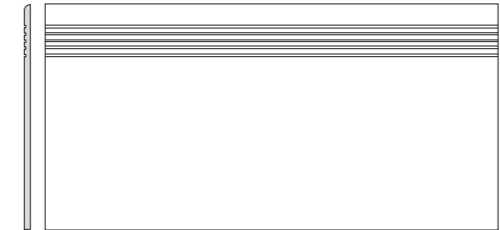

DCPSE735* | **DCPSR735**** beige | beige
DCPSE736* | **DCPSR736**** braun | brown
DCPSE737* | **DCPSR737**** grau | grey
DCPSE738* | **DCPSR738**** dunkelgrau | dark grey
DCPSE739* | **DCPSR739**** schwarz | black
PEI 4-5 ○ 270 | St
matt | R9/A

DCVSE735* | **DCVSR735**** beige | beige
DCVSE736* | **DCVSR736**** braun | brown
DCVSE737* | **DCVSR737**** grau | grey
DCVSE738* | **DCVSR738**** dunkelgrau | dark grey
DCVSE739* | **DCVSR739**** schwarz | black
PEI 4-5 ○ 270 | St
relief matt | R10/B



DSA89735 beige | beige
DSA89736 braun | brown
DSA89737 grau | grey
DSA89738 dunkelgrau | dark grey
DSA89739 schwarz | black
○ 210 | St
matt



DSAS4735* | **DSAS3735**** beige | beige
DSAS4736* | **DSAS3736**** braun | brown
DSAS4737* | **DSAS3737**** grau | grey
DSAS4738* | **DSAS3738**** dunkelgrau | dark grey
DSAS4739* | **DSAS3739**** schwarz | black
○ 180 | St
matt

80x9,5
60x7,2**

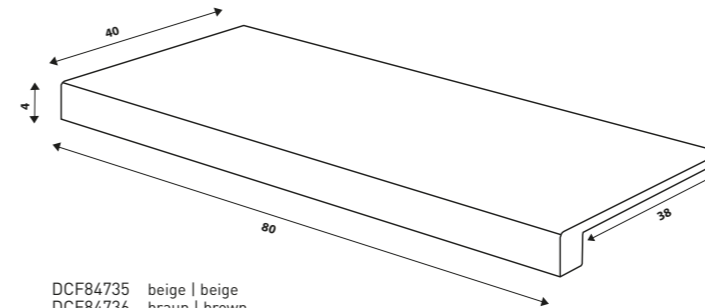

DCF84735 beige | beige
DCF84736 braun | brown
DCF84737 grau | grey
DCF84738 dunkelgrau | dark grey
DCF84739 schwarz | black
PEI 4-5 ○ 1130 | St
matt

* Verfügbar solange der Vorrat reicht | Available while stocks last

** Neues Produkt in 9 mm Stärke im Laufe des Jahres 2025 verfügbar | New product in 9 mm thickness available during 2025

Produkt product	cm	mm	EN	St/m ²	St/m ²	St/m ²	St/m ²	St/m ²	St/m ²	St/m ²	St/m ²	St/m ²
Bodenfliese floor tile*	20x20	197x197x10	EN 14411 - G Bla	23	25	0,92	57	52,44	20,1	21,9	1 174	
Bodenfliese floor tile**	20x20	197x197x9	EN 14411 - G Bla	25	25	1,00	57	57,00	19,2	19,2	1 119	
Bodenfliese floor tile*	10x10	98x98x10	EN 14411 - G Bla	10	11	0,91	56	50,96	19,9	21,9	1 142	
Bodenfliese floor tile**	10x10	98x98x9	EN 14411 - G Bla	11	11	1,00	56	56,00	19,2	19,2	1 125	
Mosaik set 30x30 cm mosaic sheet 30x30 cm*	5x5	48x48x10	EN 14411 - G Bla	3	11	0,27	-	-	5,9	-	-	
Mosaik 30x30 cm mosaic sheet 30x30 cm**	5x5	48x48x9	EN 14411 - G Bla	3	11	0,27	-	-	5,2	-	-	
Stufe step tile	40x80	398x798x10	EN 14411 - G Bla	2	3,1	0,64	-	-	14,1	21,9	-	
Stufe step tile*	30x60	298x598x10	EN 14411 - G Bla	6	5,6	1,08	-	-	23,7	-	-	
Stufe step tile**	30x60	298x598x9	EN 14411 - G Bla	5	5,6	0,90	-	-	17,3	-	-	
Sockel skirting plinth*	60x9,5	598x95x10	EN 14411 - G Bla	13	23,2	0,56	-	-	12,7	22,9	-	
Sockel skirting plinth**	60x7,2	598x72x9	EN 14411 - G Bla	14	23,1	0,60	-	-	11,5	-	-	
Stufenformteil special step tile	40x80	398x798x10	STO No. 030 - 059824	2	-	-	-	-	-	-	-	

40x80
R9/A
v3
R
RAKO Home



60x120

R11/B

v3

R

20mm



DARV6735
PEI 5 ○ 850 l m²
relief matt
beige | beige



DARV6737
PEI 5 ○ 850 l m²
relief matt
grau | grey



60x120

R11/B

v3

R

20mm



DARV6738
PEI 4 ○ 850 l m²
relief matt
dunkelgrau | dark grey

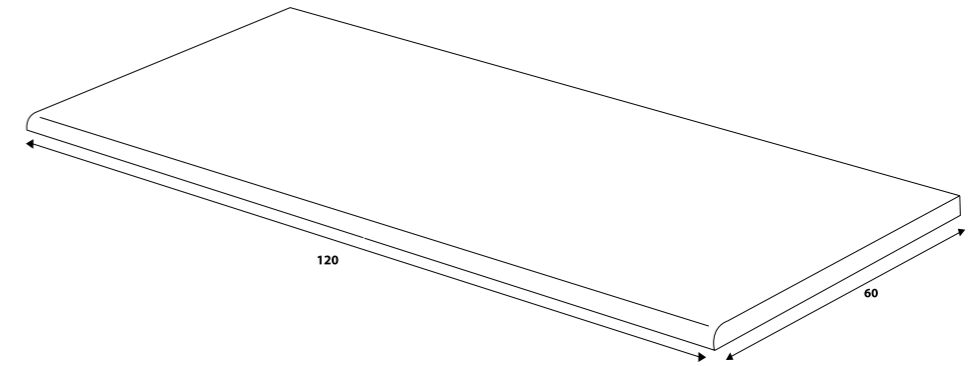

DCHV6735 beige | beige
DCHV6737 grau | grey
DCHV6738 dunkelgrau | dark grey
PEI 4-5 ○ 1150 l St
relief matt

Produkt | product



Produkt product	cm	mm	EN	St/m ²	m ²	mm	kg	kg/m ²	brutto kg		
Bodenfliese floor tile	60x120	598x1198x20	EN 14411 - G Bla	1	1,4	0,72	30	21,60	32,5	45,1	999
Stufe step tile	60x120	598x1198x20	EN 14411 - G Bla	1	-	-	-	-	32,5	-	-



DAR66735
PEI 5 ○ 760 l m² **20mm**
relief matt
beige | beige

DAR69735*
PEI 5 ○ 1390 l m² **30mm**
relief matt



DAR66736
PEI 4 ○ 760 l m² **20mm**
relief matt
braun | brown



DAR66737
PEI 5 ○ 760 l m² **20mm**
relief matt
grau | grey

DAR69737*
PEI 5 ○ 1390 l m² **30mm**
relief matt



DAR66738
PEI 4 ○ 760 l m² **20mm**
relief matt
dunkelgrau | dark grey

DAR69738*
PEI 4 ○ 1390 l m² **30mm**
relief matt

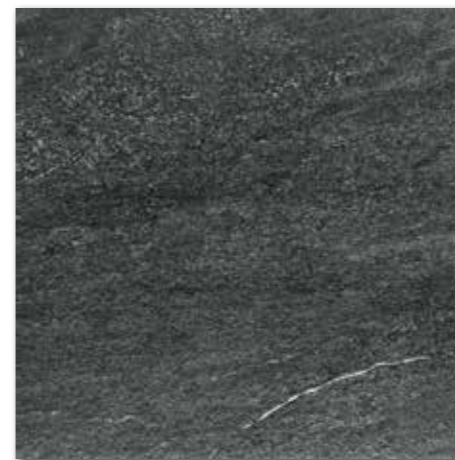

DAR66739
PEI 4 ○ 760 l m² **20mm**
relief matt
schwarz | black

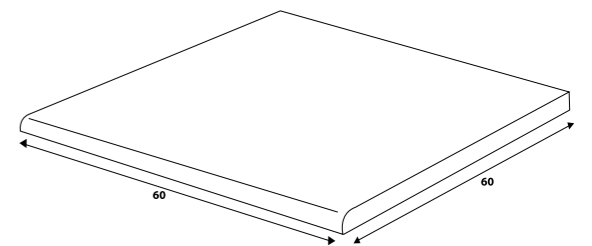

DCH66735 beige | beige
DCH66736 braun | brown
DCH66737 grau | grey | gris
DCH66738 dunkelgrau | dark grey
DCH66739 schwarz | black
PEI 4-5 ○ 780 l St
relief matt

20mm

Produkt | product



Produkt product	cm	mm	EN	St/m ²	m ²	m ²	m ²	kg	kg/m ²	brutto kg	
Bodenfliese floor tile	60-60	598-598-20	EN 14411 - G Bla	2	2,8	0,72	30	21,6	32,5	45,1	999
Bodenfliese floor tile	60-60	598-598-30	EN 14411 - G Bla	2	2,8	0,72	22	-	48,4	67,2	1 065
Stufe step tile	60-60	598-598-20	EN 14411 - G Bla	2	-	-	-	-	32,5	-	-

* Verfügbar solange der Vorrat reicht | Available while stocks last





60x120

R9/A

v3

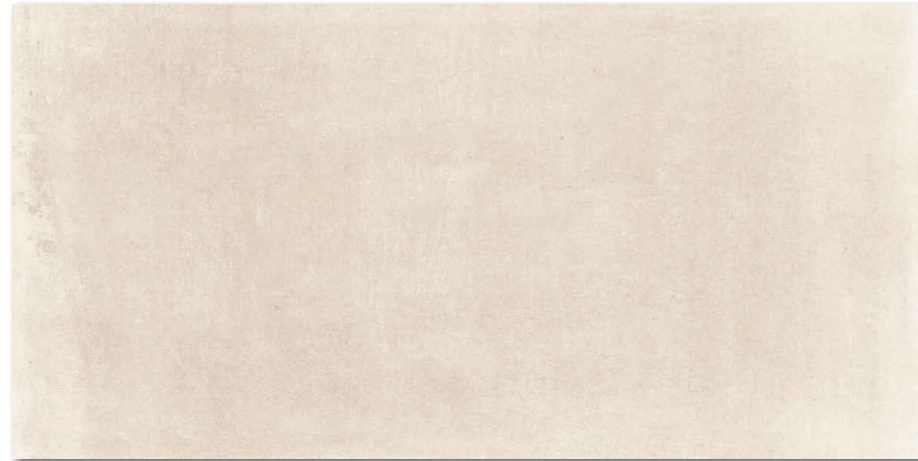

DAKV1743*
DAKV9743**
 PEI 5 ○ 700 l m²
 matt
 beige | beige



DAKV1740*
DAKV9740**
 PEI 5 ○ 700 l m²
 matt
 weiß-grau | white-grey



60x120

R9/A

v3

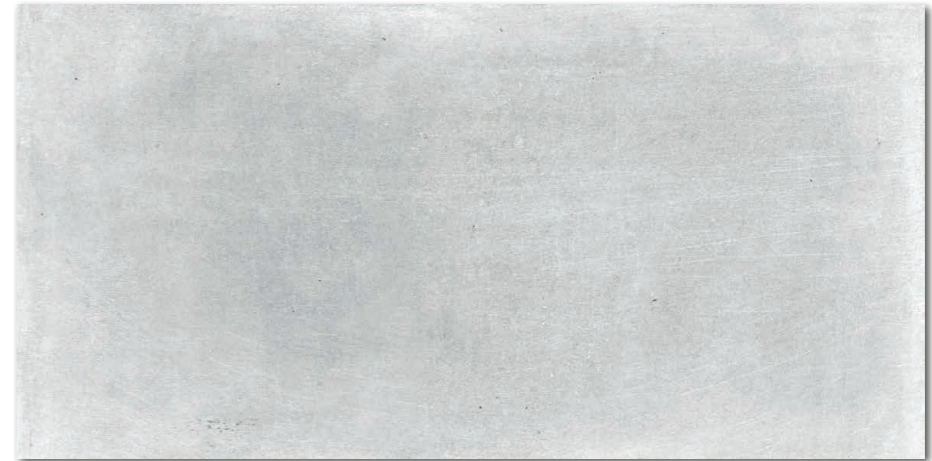

DAKV1741*
DAKV9741**
 PEI 5 ○ 700 l m²
 matt
 grau | grey

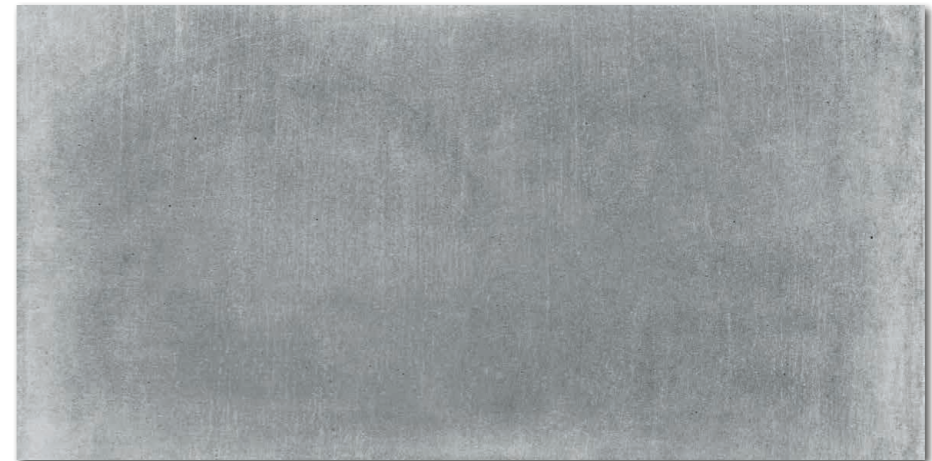

DAKV1742*
DAKV9742**
 PEI 4 ○ 700 l m²
 matt
 dunkelgrau | dark grey

Produkt | product



Bodenfliese floor tile*	60x120	598x1198x10	EN 14411 - G Bla	2	1,4	1,44	27	38,88	32,7	22,7	908
Bodenfliese floor tile**	60x120	598x1198x9	EN 14411 - G Bla	2	1,4	1,44	30	43,20	29,3	20,4	905

* Verfügbar solange der Vorrat reicht | Available while stocks last

** Neues Produkt in 9 mm Stärke im Laufe des Jahres 2025 verfügbar | New product in 9 mm thickness available during 2025



80x80
R9/A
v3
R

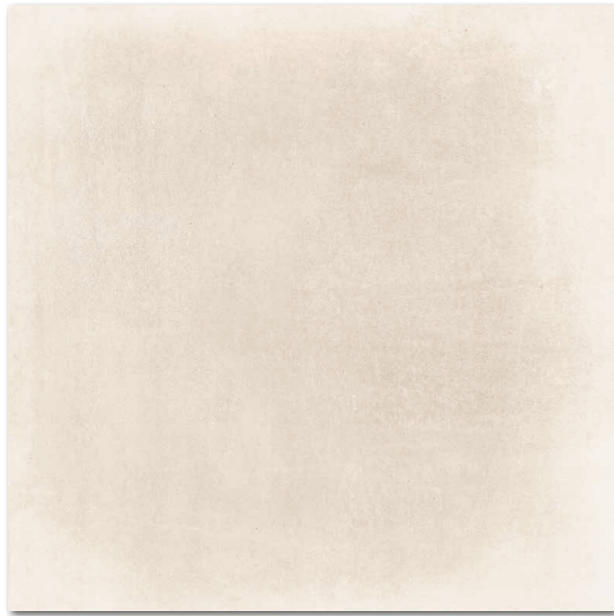

DAK81743
PEI 5 ○ 700 l m²
matt

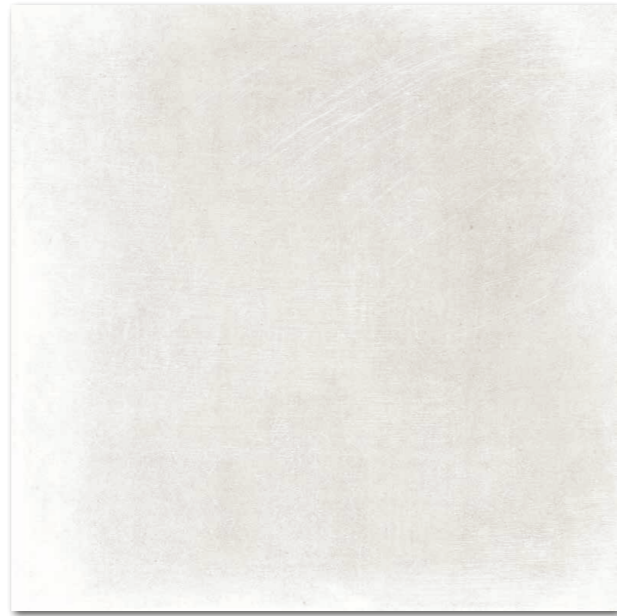

DAK81740
PEI 5 ○ 700 l m²
matt

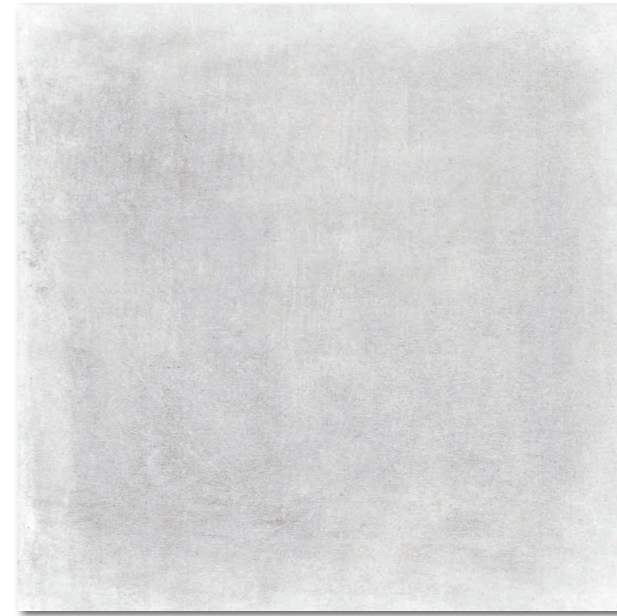

DAK81741
PEI 5 ○ 700 l m²
matt

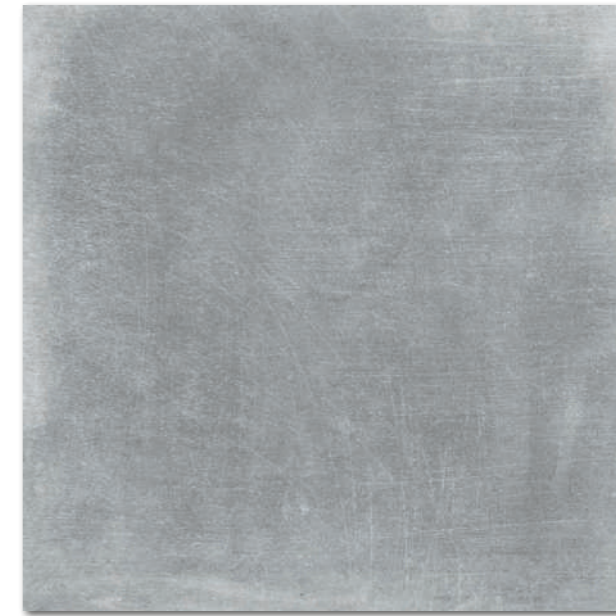

DAK81742
PEI 4 ○ 700 l m²
matt



80x80
R9/A
v3
R

40x80
R9/A
v3
R



DAK84743
PEI 5 ○ 720 l m²
matt

beige | beige

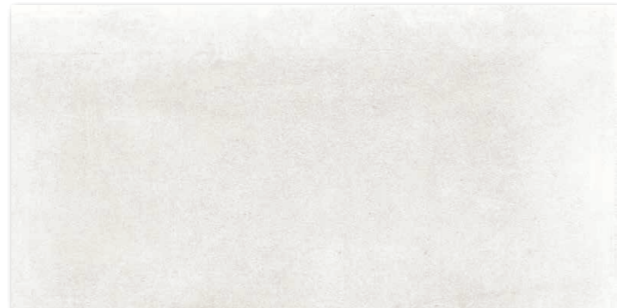

DAK84740
PEI 5 ○ 720 l m²
matt

weiß-grau | white-grey



DAK84741
PEI 5 ○ 720 l m²
matt

grau | grey



DAK84742
PEI 4 ○ 720 l m²
matt

dunkelgrau | dark grey

40x80
R9/A
v3
R

Produkt | product



Produkt product	cm	mm	EN		kg/m ²	mm	mm	mm	kg/m ²	mm	
Bodenfliese floor tile	80-80	798-798-10	EN 14411 - G Bla	2	1,6	1,28	42	53,76	28,0	21,9	1 202
Bodenfliese floor tile	40-80	398-798-10	EN 14411 - G Bla	4	3,1	1,28	42	53,76	28,0	21,9	1 202

Empfohlene Formatkombinationen siehe Seite 522-523. | Recommended combinations of modular sizes see pages 522-523.

60x60
R9/A
v3
R

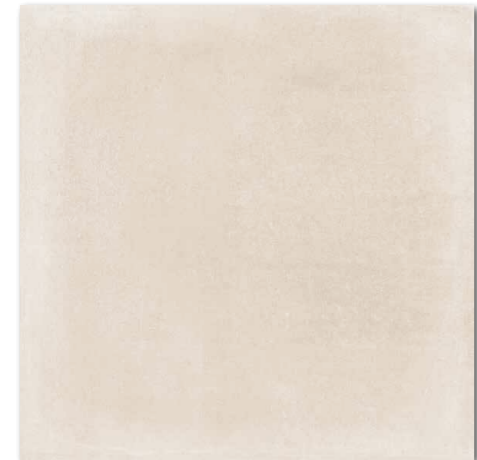

DAK63743*
DAK62743**
PEI 5 ○ 560 l m²
matt

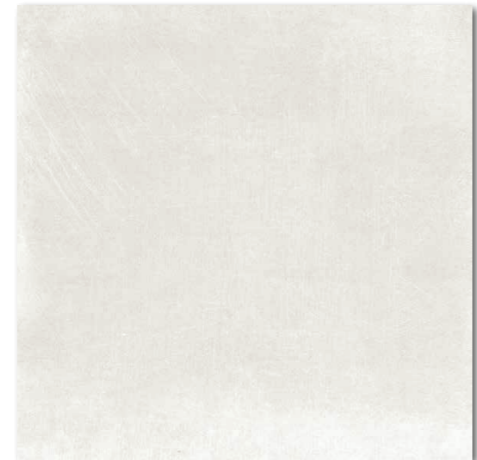

DAK63740*
DAK62740**
PEI 5 ○ 560 l m²
matt

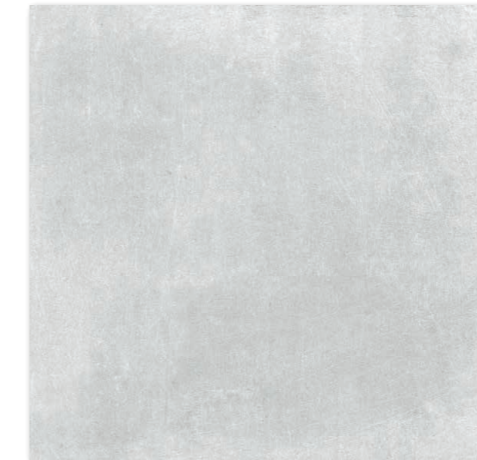

DAK63741*
DAK62741**
PEI 5 ○ 560 l m²
matt

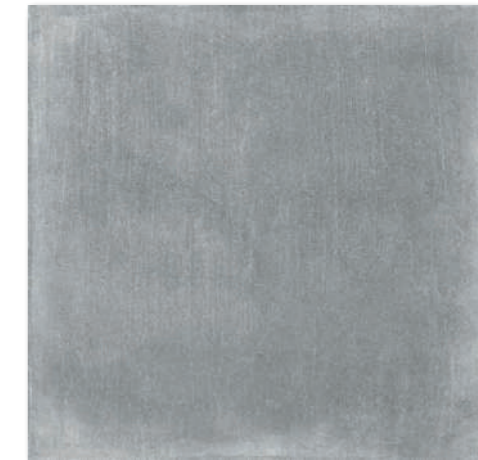

DAK63742*
DAK62742**
PEI 4 ○ 560 l m²
matt

60x60
R9/A
v3
R

30x60
R9/A
v3
R

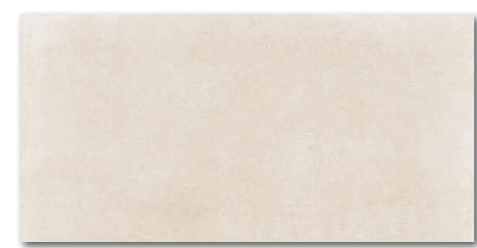

DAKSE743*
DAKSR743**
PEI 5 ○ 540 l m²
matt

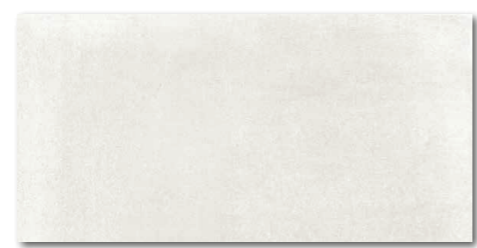

DAKSE740*
DAKSR740**
PEI 5 ○ 540 l m²
matt



DAKSE741*
DAKSR741**
PEI 5 ○ 540 l m²
matt



DAKSE742*
DAKSR742**
PEI 4 ○ 540 l m²
matt

30x60
R9/A
v3
R

45x45
R9/A
v3

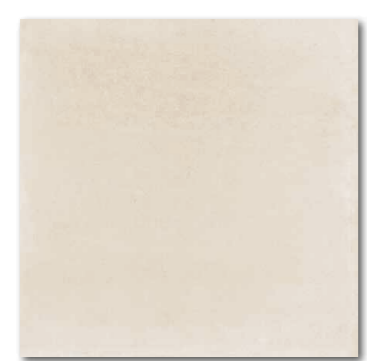

DAA4H743
PEI 5 ○ 510 l m²
matt
beige | beige

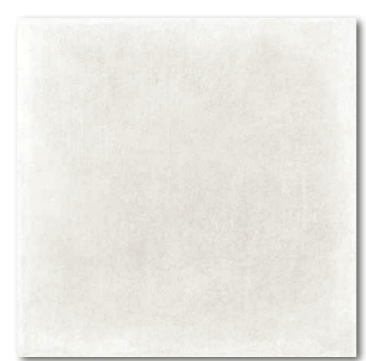

DAA4H740
PEI 5 ○ 510 l m²
matt
weiß-grau | white-grey

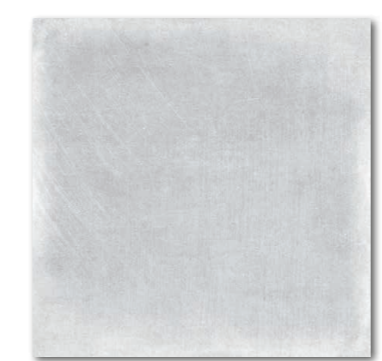

DAA4H741
PEI 5 ○ 510 l m²
matt
grau | grey



DAA4H742
PEI 4 ○ 510 l m²
matt
dunkelgrau | dark grey

45x45
R9/A
v3

Produkt product	cm	mm	EN	Stk/m ²	Stk/m ²	Stk/m ²	Stk/m ²	Stk/m ²	Stk/m ²	kg/m ²	brutto kg
Bodenfliese floor tile*	60x60	598x598x10	EN 14411 - G Bla	3	2,8	1,08	32	34,56	23,7	21,9	782
Bodenfliese floor tile**	60x60	598x598x9	EN 14411 - G Bla	4	2,8	1,44	32	46,08	29,1	20,2	955
Bodenfliese floor tile*	30x60	298x598x10	EN 14411 - G Bla	6	5,6	1,08	40	43,20	23,7	21,9	971
Bodenfliese floor tile**	30x60	298x598x9	EN 14411 - G Bla	7	5,6	1,26	40	50,40	24,2	19,2	993
Bodenfliese floor tile	45x45	448x448x8	EN 14411 - G Bla	6	5	1,21	34	41,14	21,1	17,4	741

* Verfügbar solange der Vorrat reicht | Available while stocks last

** Neues Produkt in 9 mm Stärke im Laufe des Jahres 2025 verfügbar | New product in 9 mm thickness available during 2025

Empfohlene Formatkombinationen siehe Seite 522-523. | Recommended combinations of modular sizes see pages 522-523.



DAK26743*
DAK25743**
PEI 5 ○ 780 | m²
matt | R9/A |
beige | beige

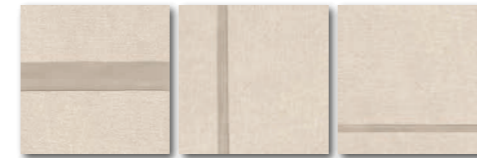

DDT26743*
DDT25743**
○ 190 | St
mattglossy |



DAK12743* (SHEET)
DAK11743**
PEI 5 ○ 900 | m²
matt | R10/B |



DDM06743* (SHEET)
DDM05743**
PEI 5 ○ 300 | Netz
matt | R10/B |

©
20x20
10x10
5x5 | 30x30



DAK26740*
DAK25740**
PEI 5 ○ 780 | m²
matt | R9/A |
weiß-grau | white-grey



DDT26740*
DDT25740**
○ 190 | St
mattglossy |

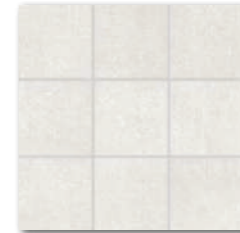

DAK12740* (SHEET)
DAK11740**
PEI 5 ○ 900 | m²
matt | R10/B |



DDM06740* (SHEET)
DDM05740**
PEI 5 ○ 300 | Netz
matt | R10/B |



DAK26741*
DAK25741**
PEI 5 ○ 780 | m²
matt | R9/A |
grau | grey



DDT26741*
DDT25741**
○ 190 | St
mattglossy |



DAK12741* (SHEET)
DAK11741**
PEI 5 ○ 900 | m²
matt | R10/B |



DDM06741* (SHEET)
DDM05741**
PEI 5 ○ 300 | Netz
matt | R10/B |



DAK26742*
DAK25742**
PEI 4 ○ 780 | m²
matt | R9/A |
dunkelgrau | dark grey



DDT26742*
DDT25742**
○ 190 | St
mattglossy |

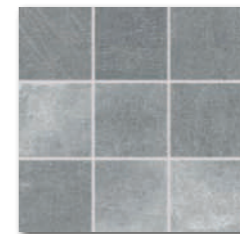

DAK12742* (SHEET)
DAK11742**
PEI 4 ○ 900 | m²
matt | R10/B |

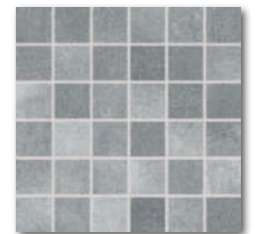

DDM06742* (SHEET)
DDM05742**
PEI 4 ○ 300 | Netz
matt | R10/B |

Produkt product	cm	mm	EN		St/m ²					kg/m ²	
Bodenfliese floor tile*	20x20	197x197x10	EN 14411 - G Bla	23	25	0,92	57	52,44	20,1	21,9	1 174
Bodenfliese floor tile**	20x20	197x197x9	EN 14411 - G Bla	25	25	1,00	57	57,00	19,2	19,2	1 119
Dekor Idecor*	20x20	198x198x10	EN 14411 - G Bla	3	25	0,12	-	-	2,6	21,9	-
Dekor Idecor**	20x20	198x198x9	EN 14411 - G Bla	3	25	0,12	-	-	2,6	21,9	-
Bodenfliese floor tile*	10x10	98x98x10	EN 14411 - G Bla	10	11	0,91	56	50,96	19,9	21,9	1 142
Bodenfliese floor tile**	10x10	98x98x9	EN 14411 - G Bla	11	11	1,00	56	56,00	19,2	19,2	1 125
Mosaik set 30x30 cm mosaic sheet 30x30 cm*	5x5	48x48x10	EN 14411 - G Bla	3	11	0,27	-	-	5,9	-	-
Mosaik 30x30 cm mosaic sheet 30x30 cm**	5x5	48x48x9	EN 14411 - G Bla	3	11	0,27	-	-	5,2	-	-

* Verfügbar solange der Vorrat reicht | Available while stocks las

** Neues Produkt in 9 mm Stärke im Laufe des Jahres 2025 verfügbar | New product in 9 mm thickness available during 2025

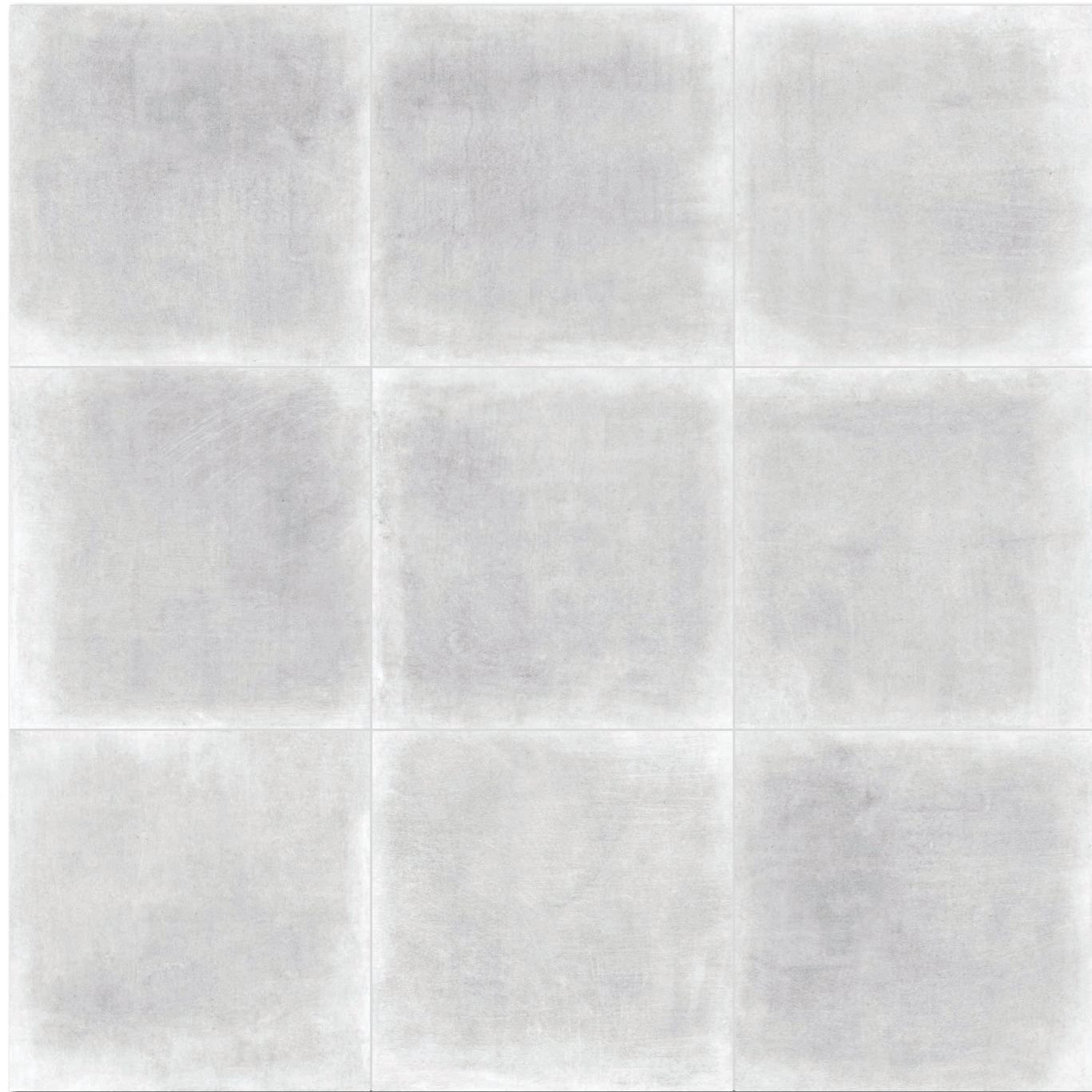

Die Fliesen der Serie zeichnen sich durch ein breites Farbspiel V3 aus. | All products of the entire batch show big deviations in shade difference V3.

Wir empfehlen, einzelne Fliesen aus mehreren Paketen herauszunehmen und den gesamten Bodenbelag nach der Inspirationsfotodokumentation in den Katalogen RAKO, eventuell den Webseiten www.rako.eu, zu komponieren. Wünschenswert ist die Kombination aller Fliesendesigns einschließlich ihrer Drehung um 90° oder 180°, sodass ausgewogene Optik der verlegten Fläche erzielt wird.

Before laying the tiles, we suggest you select from several cartons and arrange them as illustrated in the inspiration photo documentation in RAKO catalogues or website www.rako.eu, and mix the tiles to achieve the required result including turning them by 90° or 180°.

Produkt product	cm	mm	EN	Stk	St/m ²	m ² /Stk	kg	kg/m ²	brutto h _g
Stufe step tile*	30x120	298x1198x10	EN 14411 - G Bla	3/5	2,8	1,08/1,8	-	-	24,6/40,9
Stufe step tile**	30x120	298x1198x9	EN 14411 - G Bla	3	2,8	1,08	-	-	22,5
Stufe step tile	40x80	398x798x10	EN 14411 - G Bla	2	3,1	0,64	-	-	14,1
Stufe step tile*	30x60	298x598x10	EN 14411 - G Bla	6	5,6	1,08	-	-	23,7
Stufe step tile**	30x60	298x598x9	EN 14411 - G Bla	5	5,6	0,90	-	-	17,3
Sockel skirting plinth	80x9,5	798x95x10	EN 14411 - G Bla	10	13,2	0,76	-	-	16,7
Sockel skirting plinth*	60x9,5	598x95x10	EN 14411 - G Bla	13	17,5	0,74	-	-	16,2
Sockel skirting plinth**	60x7,2	598x72x9	EN 14411 - G Bla	14	23,1	0,60	-	-	11,5
Sockel skirting plinth	45x8,5	448x85x8	EN 14411 - G Bla	25	26,1	0,96	-	-	16,7
Stufenformteil special step tile	40x80	398x798x10	STO No. 030 - 059824	2	-	-	-	-	16,5
Stufenformteil special step tile*	30x120	298x1198x10	STO No. 030 - 059824	2	-	-	-	-	-
Stufenformteil special step tile**	30x120	298x1198x9	STO No. 030 - 059824	2	-	-	-	-	-



30x120

R9/A

v3

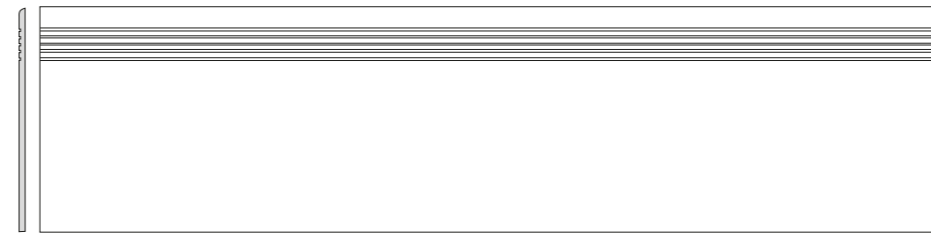

DCPVF740* | **DCPVD740**** weiß-grau | white-grey
 DCPVF741* | **DCPVD741**** grau | grey
 DCPVF742* | **DCPVD742**** dunkelgrau | dark grey
 DCPVF743* | **DCPVD743**** beige | beige
 PEI 4-5 ○ 740 | St
 matt

40x80

30x60

R9/A

v3

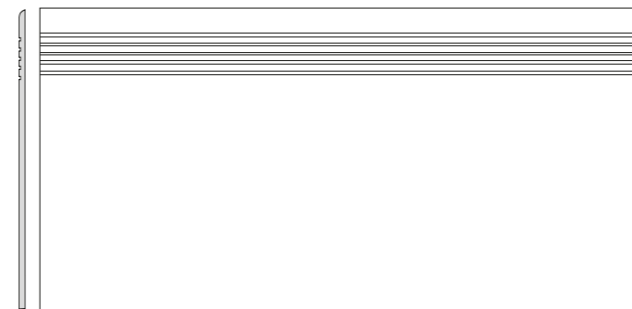

DCP84740 weiß-grau | white-grey
 DCP84741 grau | grey
 DCP84742 dunkelgrau | dark grey
 DCP84743 beige | beige
 PEI 4-5 ○ 380 | St
 matt

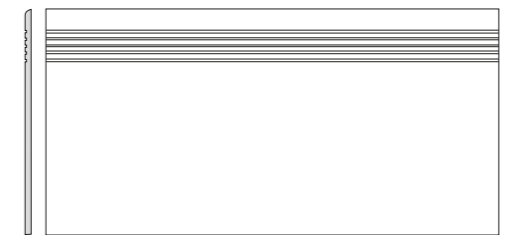

DCPSE740* | **DCPSR740**** weiß-grau | white-grey
 DCPSE741* | **DCPSR741**** grau | grey
 DCPSE742* | **DCPSR742**** dunkelgrau | dark grey
 DCPSE743* | **DCPSR743**** beige | beige
 PEI 4-5 ○ 270 | St
 matt

80x9,5

60x9,5*

60x7,2**



DSA89740 weiß-grau | white-grey
 DSA89741 grau | grey
 DSA89742 dunkelgrau | dark grey
 DSA89743 beige | beige
 ○ 210 | St
 matt



DSAS4740* | **DSAS3740**** weiß-grau | white-grey
 DSAS4741* | **DSAS3741**** grau | grey
 DSAS4742* | **DSAS3742**** dunkelgrau | dark grey
 DSAS4743* | **DSAS3743**** beige | beige
 ○ 180 | St
 matt

45x8,5



DSAPS740 weiß-grau | white-grey
 DSAPS741 grau | grey
 DSAPS742 dunkelgrau | dark grey
 DSAPS743 beige | beige
 ○ 160 | St
 matt

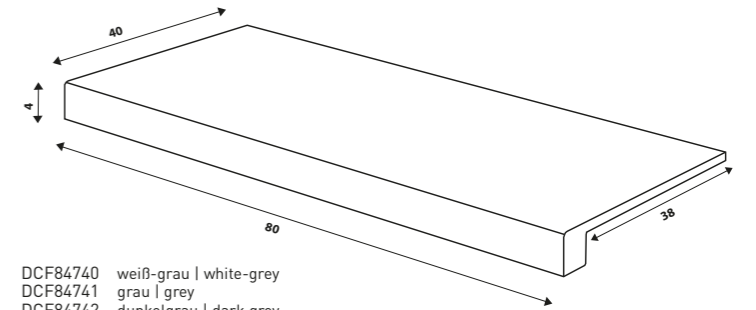

40x80

R9/A

v3



DCF84740 weiß-grau | white-grey
 DCF84741 grau | grey
 DCF84742 dunkelgrau | dark grey
 DCF84743 beige | beige
 PEI 4-5 ○ 1130 | St
 matt

30x120

R9/A

v3

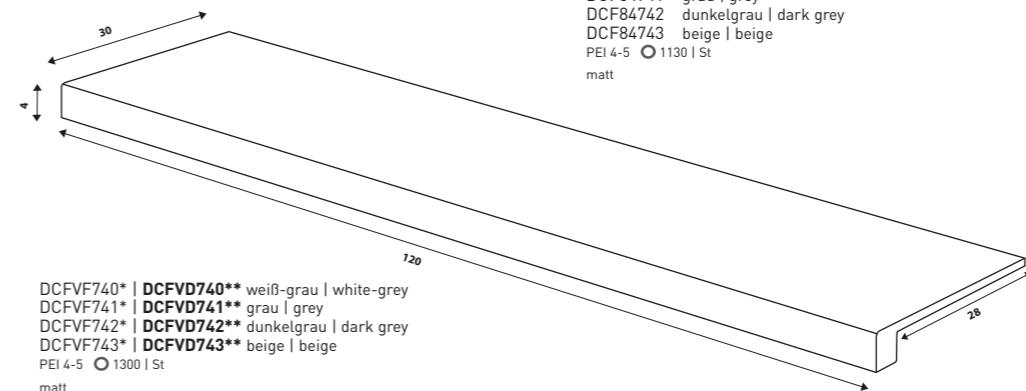

DCFVF740* | **DCFVD740**** weiß-grau | white-grey
 DCFVF741* | **DCFVD741**** grau | grey
 DCFVF742* | **DCFVD742**** dunkelgrau | dark grey
 DCFVF743* | **DCFVD743**** beige | beige
 PEI 4-5 ○ 1300 | St
 matt

* Verfügbar solange der Vorrat reicht | Available while stocks last

** Neues Produkt in 9 mm Stärke im Laufe des Jahres 2025 verfügbar | New product in 9 mm thickness available during 2025

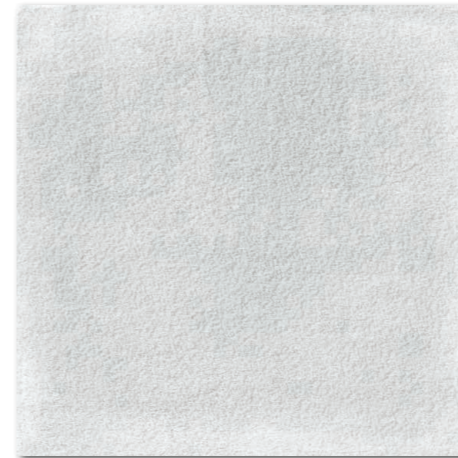

DAR66741
PEI 5 \odot 760 | m²
relief matt
grau | grey



DAR66742
PEI 4 \odot 760 | m²
relief matt
dunkelgrau | dark grey



DAR66743
PEI 5 \odot 760 | m²
relief matt
beige | beige

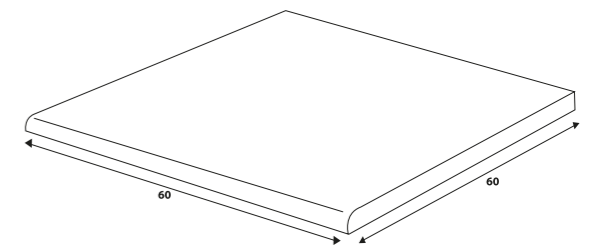

DCH66741 grau | grey
DCH66742 dunkelgrau | dark grey
DCH66743 beige | beige
PEI 4-5 \odot 780 | St
relief matt

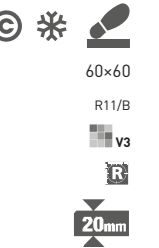

Produkt | product

cm	mm	EN	St/m ²	kg/m ²	product kg					
60x60	598x598x20	EN 14411 - G B1a	2	2,8	0,72	30	21,6	32,5	45,1	999
60x60	598x598x20	EN 14411 - G B1a	2	-	-	-	-	32,5	-	-

Bodenfliese | floor tile
Stufe | step tile

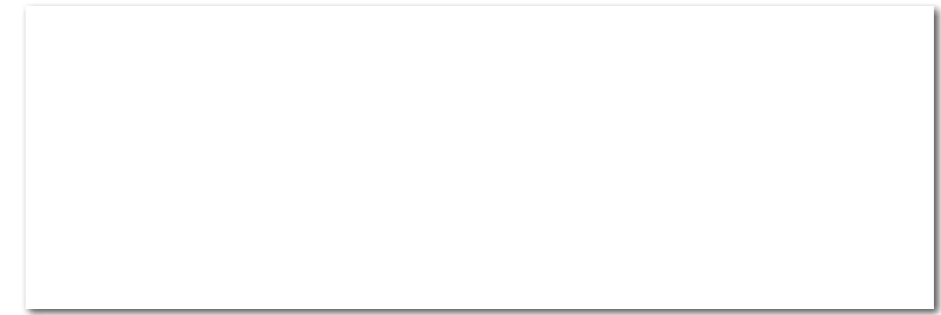

WAKV6104
System
○ 650 l m²
matt
weiß | white

WAKV6000
System
○ 650 l m²
glossy

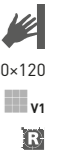

WDV42668
○ 500 l Netz
matt|glossy
weiß-grau | white-grey

(SHEET)



WDV42669
○ 500 l Netz
matt|glossy
grau-weiß | grey-white

(SHEET)

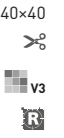

Produkt | product

	cm	mm	EN	Stk	Stk/m ²	Stk/m ²	Stk/m ²	Stk/m ²	Stk/m ²	kg/m ²	kg/m ²
Wandfliese wall tile	40x120	398x1198x10	EN 14411 - L-BIII	3	2,1	1,44	21	30,24	29,0	20,1	633
Dekor I decor (WDV42668)	40x40	398x398x10	STO No. 030 - 059826	3	6,25	0,48	-	-	9,3	19,4	-
Dekor I decor (WDV42669)	40x40	398x398x10	STO No. 030 - 059826	3	6,25	0,48	-	-	10,5	21,3	-

Wir empfehlen die Kombination mit den Fliesen der Serie Rebel. | To combine with Rebel floor tiles is recommended.



WAKVK521
 ○ 500 l m²
 mattglossy
 hellgrau | light grey

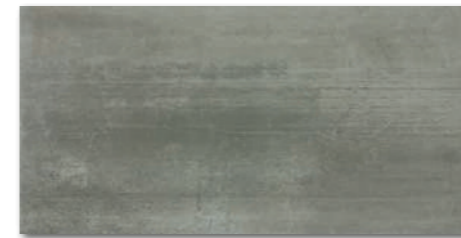

WAKVK522
 ○ 500 l m²
 mattglossy
 dunkelgrau | dark grey



WAKVK523
 ○ 500 l m²
 mattglossy



DDRSN972
 ○ 610 l St
 glossy
 hell blau | light blue



WLAVP523
 ○ 350 l St
 mattglossy
 schwarz | black



WDM05521 (SHEET)
 ○ 250 l Netz
 mattglossy
 hellgrau | light grey



WDM05522 (SHEET)
 ○ 250 l Netz
 mattglossy
 dunkelgrau | dark grey

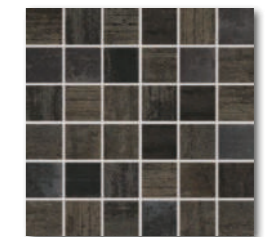

WDM05523 (SHEET)
 ○ 250 l Netz
 mattglossy
 schwarz | black

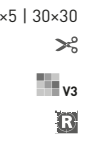

Produkt product	cm	mm	EN	St/m ²	kg/m ²	St/Netz	kg/Netz	St/Netz	kg/Netz	St/Netz	kg/Netz
Wandfliese wall tile	30x60	298x598x8	EN 14411 - L BIII	8	5,56	1,44	40	57,60	21,3	14,8	876
Bordüre listel	60x2	598x20x10	EN 14411 - G Bla	6	83,3	0,07	-	-	1,6	22,7	-
Bordüre listel	60x4,8	598x48x8	EN 14411 - L BIII	14	33,3	0,42	-	-	6,1	14,8	-
Mosaik set 30x30 cm mosaic sheet 30x30 cm	5x5	48x48x8	STO No. 030 - 059826	4	11	0,36	-	-	5,2	14,8	-

Wir empfehlen die Kombination mit den Fliesen der Serie Extra. | To combine with Extra floor tiles is recommended.



Die Fliesen der Serie zeichnen sich durch ein breites Farbspiel V3/V4 aus. | All products of the entire batch show big deviations in shade difference V3/V4.

Wir empfehlen, einzelne Fliesen aus mehreren Paketen herauszunehmen und den gesamten Bodenbelag nach der Inspirationsfotodokumentation in den Katalogen RAKO, eventuell den Webseiten www.rako.eu, zu komponieren. Wünschenswert ist die Kombination aller Fliesendesigns einschließlich ihrer Drehung um 180°, sodass ausgewogene Optik der verlegten Fläche erzielt wird.

Before laying the tiles, we suggest you select from several cartons and arrange them as illustrated in the inspiration photo documentation in RAKO catalogues or website www.rako.eu, and mix the tiles to achieve the required result including turning them by 180°.



WAKVK518
 ○ 500 | m²
 mattglossy | V3
 hellbeige | light beige



WAKVK519
 ○ 500 | m²
 mattglossy | V4
 kupferig | cupreous



WAKVK520
 ○ 500 | m²
 mattglossy | V3



DDRSN970
 ○ 610 | St
 glossy
 orange | orange



WLAVP520
 ○ 350 | St
 mattglossy
 dunkelbraun | dark brown



30x60



60x2
60x4,8



WDM05518 (SHEET)
 ○ 250 | Netz
 mattglossy | V3
 hellbeige | light beige



WDM05519 (SHEET)
 ○ 250 | Netz
 mattglossy | V4
 kupferig | cupreous

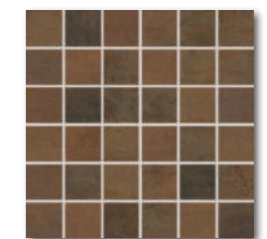

WDM05520 (SHEET)
 ○ 250 | Netz
 mattglossy | V3
 dunkelbraun | dark brown



5x5 | 30x30

Produkt product	cm	mm	EN	St/m ²	kg/m ²	brutto kg
Wandfliese wall tile	30x60	298x598x8	EN 14411 - L BIII	8	5,56	1,44
Bordüre listel	60x2	598x20x10	EN 14411 - G BIIa	6	83,3	0,07
Bordüre listel	60x4,8	598x48x8	EN 14411 - L BIII	14	33,3	0,42
Mosaik set 30x30 cm mosaic sheet 30x30 cm	5x5	48x48x8	STO No. 030 - 059826	4	11	0,36

Wir empfehlen die Kombination mit den Fliesen der Serie Extra. | To combine with Extra floor tiles is recommended.



WAKVK160
 ○ 500 l m²
 matt
 elfenbein | ivory

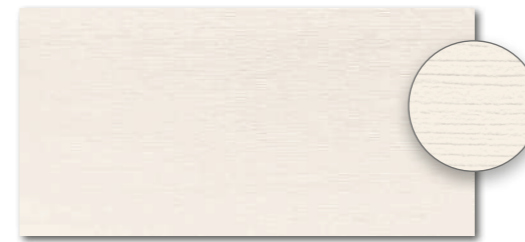

WAKVK161
 ○ 500 l m²
 matt
 hellbeige | light beige



WAKVK162
 ○ 500 l m²
 matt
 hellgrau | light grey

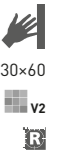



30x120



DAKVF745
PEI 5 \bigcirc 770 | m²
matt

20x120



DAKVG745
PEI 5 \bigcirc 770 | m²
matt

20x80

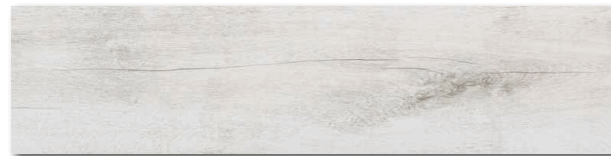

DAK82745
PEI 5 \bigcirc 610 | m²
matt
weiß-grau | white-grey

30x120



DAKVF746
PEI 4 \bigcirc 770 | m²
matt

20x120

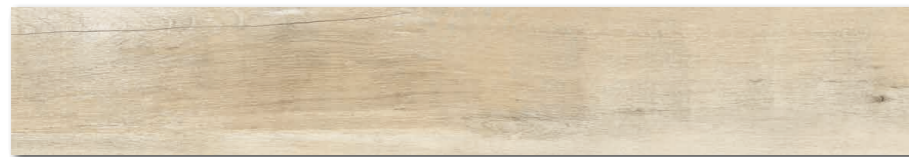

DAKVG746
PEI 4 \bigcirc 770 | m²
matt

20x80



DAK82746
PEI 4 \bigcirc 610 | m²
matt
beige | beige



30x120



DAKVF747
PEI 4 \bigcirc 770 | m²
matt

20x120



DAKVG747
PEI 4 \bigcirc 770 | m²
matt

20x80

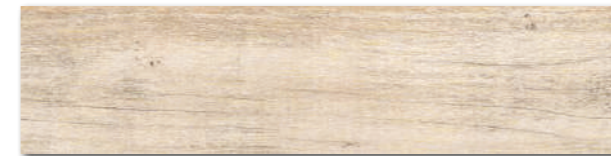

DAK82747
PEI 4 \bigcirc 610 | m²
matt
hellbraun | light brown

30x120



DAKVF748
PEI 4 \bigcirc 770 | m²
matt

20x120

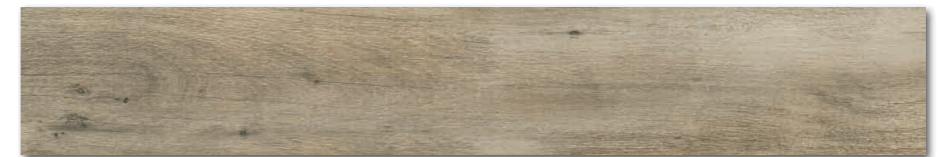

DAKVG748
PEI 4 \bigcirc 770 | m²
matt

20x80

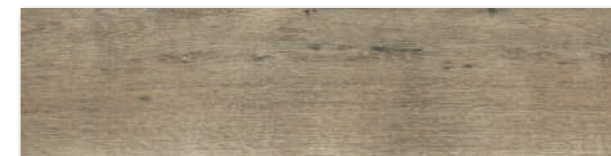

DAK82748
PEI 4 \bigcirc 610 | m²
matt
dunkelbraun | dark brown

Produkt product	cm	mm	EN	St/m ²	kg/m ²	mm	mm	mm	mm	mm	kg/m ²	kg/m ²
Bodenfliese floor tile	30x120	298x1198x10	EN 14411 - G Bla	3	2,8	1,08	40	43,20	24,5	22,7	1 006	
Bodenfliese floor tile	20x120	198x1198x10	EN 14411 - G Bla	4	4,2	0,96	32	30,72	21,8	22,7	723	
Bodenfliese floor tile	20x80	197x798x10	EN 14411 - G Bla	4	6,25	0,64	72	46,08	14,0	21,9	1 034	

Empfohlene Formatkombinationen siehe Seite 522-523. | Recommended combinations of modular sizes see pages 522-523.



Die Fliesen der Serie zeichnen sich durch ein breites Farbspiel V3 aus. | All products of the entire batch show big deviations in shade difference V3.

Wir empfehlen, einzelne Fliesen aus mehreren Paketen herauszunehmen und den gesamten Bodenbelag nach der Inspirationsfotodokumentation in den Katalogen RAKO, eventuell den Webseiten www.rako.eu, zu komponieren. Wünschenswert ist die Kombination aller Fliesendesigns einschließlich ihrer Drehung um 180°, sodass ausgewogene Optik der verlegten Fläche erzielt wird.

Before laying the tiles, we suggest you select from several cartons and arrange them as illustrated in the inspiration photo documentation in RAKO catalogues or website www.rako.eu, and mix the tiles to achieve the required result including turning them by 180°.



DAK26746
PEI 4 ○ 780 | m²
matt



DAK26747
PEI 4 ○ 780 | m²
matt



DAK26745
PEI 5 ○ 780 | m²
matt



DAK26748
PEI 4 ○ 780 | m²
matt



DDM06746 (SHEET)
PEI 4 ○ 300 | Netz
matt
beige | beige

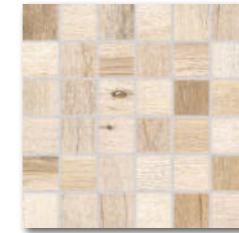

DDM06747 (SHEET)
PEI 4 ○ 300 | Netz
matt
hellbraun | light brown



DDM06745 (SHEET)
PEI 5 ○ 300 | Netz
matt
weiß-grau | white-grey

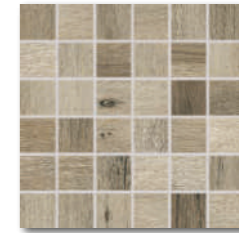

DDM06748 (SHEET)
PEI 4 ○ 300 | Netz
matt
dunkelbraun | dark brown



DCPVF745 weiß-grau | white-grey
DCPVF746 beige | beige
DCPVF747 hellbraun | light brown
DCPVF748 dunkelbraun | dark brown
PEI 4-5 ○ 740 | St
matt



DSASP745 weiß-grau | white-grey
DSASP746 beige | beige
DSASP747 hellbraun | light brown
DSASP748 dunkelbraun | dark brown
○ 180 | St
matt

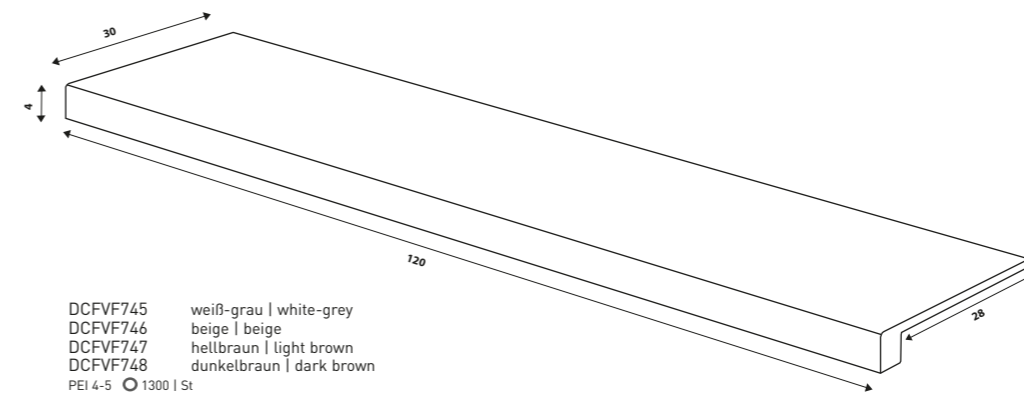

DCFVF745 weiß-grau | white-grey
DCFVF746 beige | beige
DCFVF747 hellbraun | light brown
DCFVF748 dunkelbraun | dark brown
PEI 4-5 ○ 1300 | St
matt



20×20

R9/A

v3

R

5×5 | 30×30

R10/B

v3

R

30×120

R9/A

v3

R

60×7,2

R

30×120

R9/A

v3

R

Produkt | product

	cm	mm	EN	St/m ²	kg/m ²	St/m ²	kg/m ²	St/m ²	kg/m ²	St/m ²	kg/m ²
Mosaik set 30×30 cm mosaic sheet 30×30 cm	5×5	48×48×10	EN 14411 - G Bla	3	11	0,27	-	-	5,9	22,7	-
Bodenfliese floor tile	20×20	198×198×10	EN 14411 - G Bla	23	25	0,92	57	52,44	20,9	22,7	1 216
Stufe step tile	30×120	298×1198×10	EN 14411 - G Bla	3/5	2,8	1,08/1,8	-	-	24,6/40,9	22,7	-
Stufenformteil special step tile	30×120	298×1198×10	STO No. 030 - 059824	2	-	-	-	-	-	-	-
Sockel skirting plinth	60×7,2	598×72×10	EN 14411 - G Bla	13	23,2	0,56	-	-	12,3	21,9	-

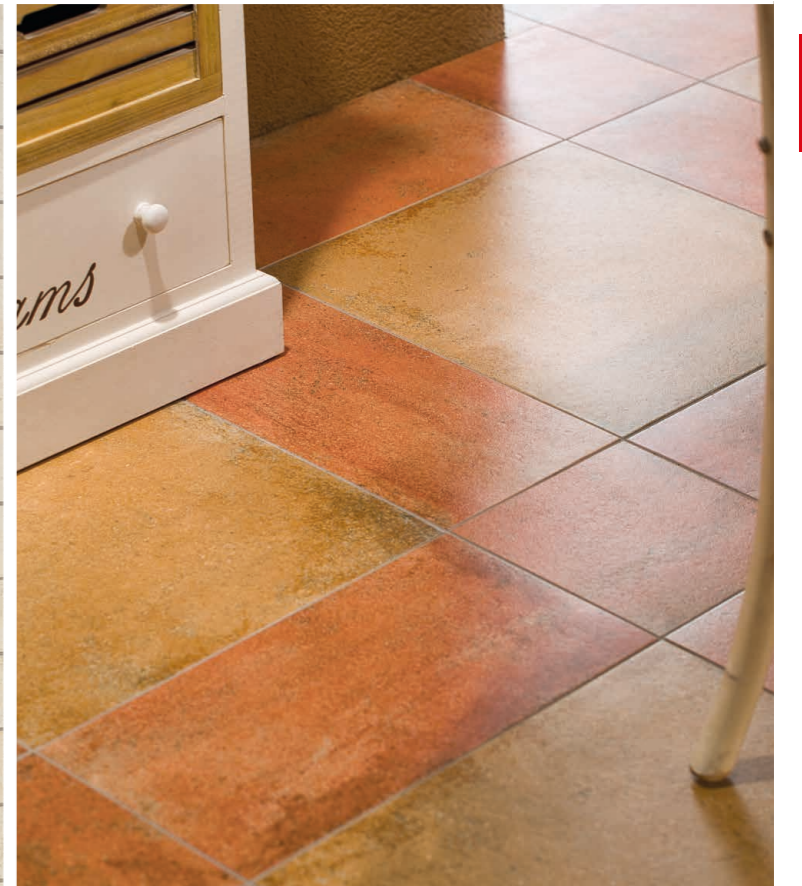



Die Fliesen der Serie zeichnen sich durch ein breites Farbspiel V3 aus. | All products of the entire batch show big deviations in shade difference V3.

Wir empfehlen, einzelne Fliesen aus mehreren Paketen herauszunehmen und den gesamten Bodenbelag nach der Inspirationsfotodokumentation in den Katalogen RAKO, eventuell den Webseiten www.rako.eu, zu komponieren. Wünschenswert ist die Kombination aller Fliesendesigns einschließlich ihrer Drehung um 90° oder 180°, sodass ausgewogene Optik der verlegten Fläche erzielt wird.

Before laying the tiles, we suggest you select from several cartons and arrange them as illustrated in the inspiration photo documentation in RAKO catalogues or website www.rako.eu, and mix the tiles to achieve the required result including turning them by 90° or 180°.

Produkt product	cm	mm	EN	Stk/m ²	m ² /Stk	kg/m ²	kg/Stk	brutto kg
Bodenfliese floor tile	45x45	445x445x8	EN 14411 - G Bla	6	5	1,21	34	41,14
Bodenfliese floor tile	22,5x45	221x445x8	EN 14411 - G Bla	12	9,9	1,21	48	58,08
Bodenfliese floor tile	22,5x22,5	221x221x8	EN 14411 - G Bla	25	19,8	1,26	45	56,70
Dekor decor	45x45	445x445x8	EN 14411 - G Bla	5	5	1,01	-	-
Sockel skirting plinth	45x8,5	445x85x8	EN 14411 - G Bla	25	26,1	0,96	-	-



45x45

R9

v3

R



DAR4H663
PEI 5 ○ 520 l m²
relief matt



DAR4H664
PEI 4 ○ 520 l m²
relief matt



DAR4H665
PEI 4 ○ 520 l m²
relief matt

22,5x45

R9

v3

R

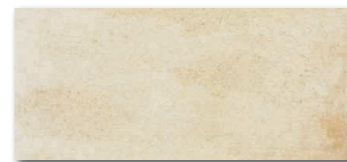

DARPT663
PEI 5 ○ 630 l m²
relief matt

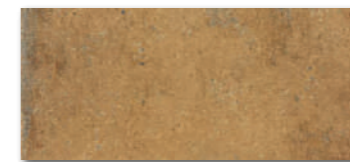

DARPT664
PEI 4 ○ 630 l m²
relief matt

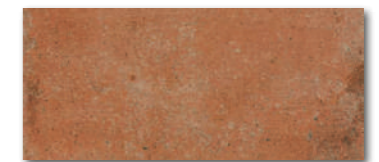

DARPT665
PEI 4 ○ 630 l m²
relief matt

22,5x22,5

R9

v3

R

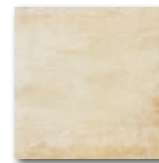

DAR2Y663
PEI 5 ○ 630 l m²
relief matt



DAR2Y664
PEI 4 ○ 630 l m²
relief matt



DAR2Y665
PEI 4 ○ 630 l m²
relief matt

45x45

R9/A

v3

R



DDP4H663 (SHEET)
PEI 5 ○ 460 | Netz
relief matt
hellbeige | light beige



DDP4H664 (SHEET)
PEI 4 ○ 460 | Netz
relief matt
braun | brown

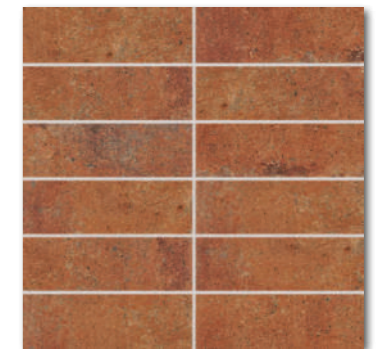

DDP4H665 (SHEET)
PEI 4 ○ 460 | Netz
relief matt
rot-braun | red-brown

45x8,5

R



DSAPS663 hellbeige | light beige
DSAPS664 braun | brown
DSAPS665 rot-braun | red-brown
○ 160 | St
relief matt

Empfohlene Formatkombinationen siehe Seite 522-523. | Recommended combinations of modular sizes see pages 522-523.

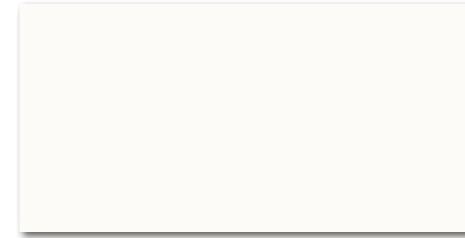

WAKVK546
 ○ 500 l m²
 matt
 elfenbein | ivory

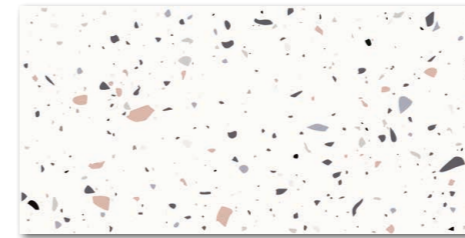

WAKVK547
 ○ 500 l m²
 matt
 rot-braun - blau-grau - schwarz | red-brown - blue-grey - black

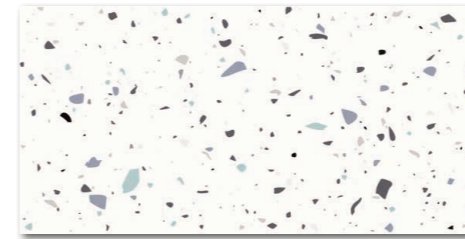

WAKVK548
 ○ 500 l m²
 matt
 blau - türkis - schwarz | blue - turquoise - black



WAKVK549
 ○ 500 l m²
 matt
 grün - grün-gelb - schwarz | green - green-yellow - black

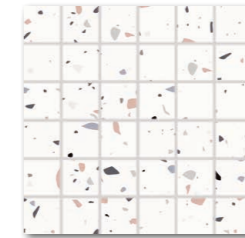

WDM05547 (SHEET)
 ○ 250 l Netz
 matt | ☞

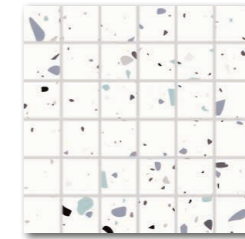

WDM05548 (SHEET)
 ○ 250 l Netz
 matt | ☞

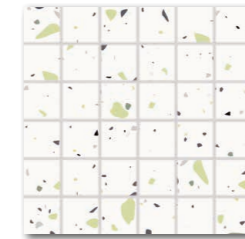

WDM05549 (SHEET)
 ○ 250 l Netz
 matt | ☞

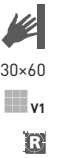

Produkt | product

Wandfliese wall tile	30×60	298×598×8	EN 14411 - L BIII	8	5,56	1,44	40	57,60	21,3	14,8	876
Mosaik set 30×30 cm mosaic sheet 30×30 cm	5×5	48×48×8	STO No. 030 - 059826	4	11	0,36	-	-	5,2	14,8	-

Wir empfehlen die Kombination mit den Fliesen der Serie Blend, Pino, Plank, Rebel und Saloon. | To combine with Blend, Pino, Plank, Rebel und Saloon floor tiles is recommended.

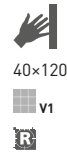

40x120

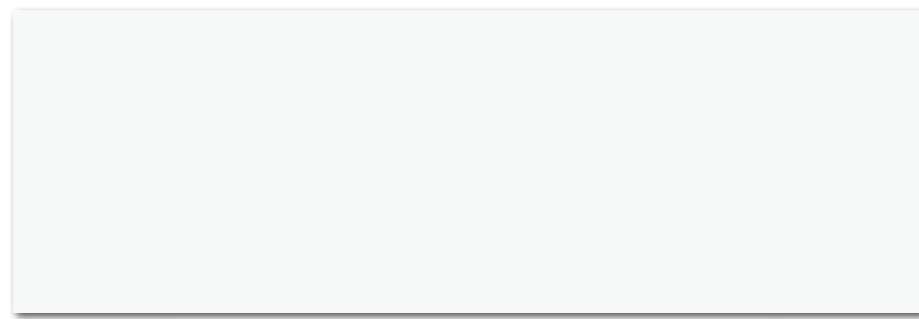

WAKV6104
○ 650 l m²
matt

WAKV6000
○ 650 l m²
glossy



30x90

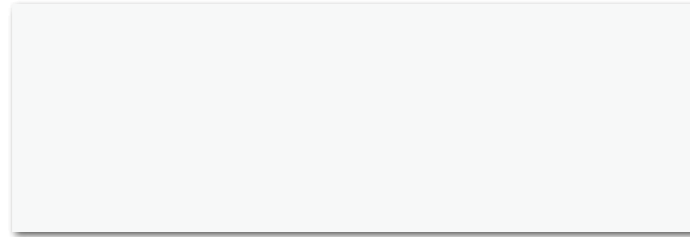

WAKV5104*
WAKVN104**
○ 660 l m²
matt

WAKV5000*
WAKVN000**
○ 660 l m²
glossy



30x90
30x60



WR1V5104
○ 750 l m²
matt

WR1V5000
○ 750 l m²
relief glossy



WR1VK104
○ 500 l m²
relief matt

WR1VK000
○ 500 l m²
relief glossy



30x90
30x60



WR2V5104*
WR2VN104**
○ 750 l m²
relief matt

WR2V5000*
WR2VN000**
○ 750 l m²
relief glossy



WR2VK104
○ 500 l m²
relief matt

WR2VK000
○ 500 l m²
relief glossy



30x60

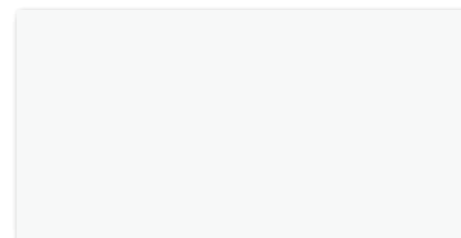

WAKVK104
○ 480 l m²
matt | **V1**

WAKVK000
○ 480 l m²
glossy | **V1**

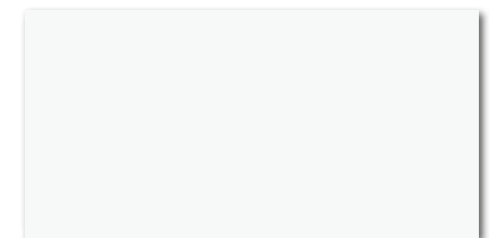

WAAVK104
○ 430 l m²
matt

WAAVK000
○ 430 l m²
glossy

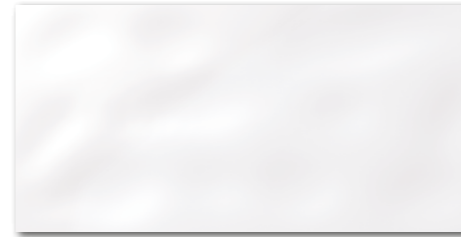

WARVK104
○ 480 l m²
relief matt

WARVK000
○ 480 l m²
relief glossy

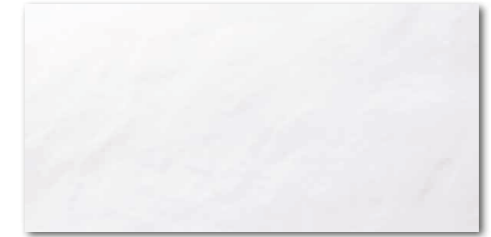

WAGVK104
○ 480 l m²
relief matt

WAGVK000
○ 480 l m²
relief glossy



30x60

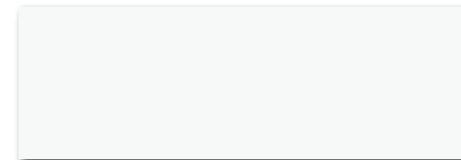

WAAVE104
○ 430 l m²
matt

WAAVE000
○ 430 l m²
glossy

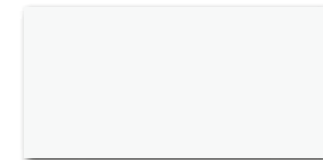

WAAMB104
○ 390 l m²
matt

WAAMB000
○ 390 l m²
glossy



20x60
20x40

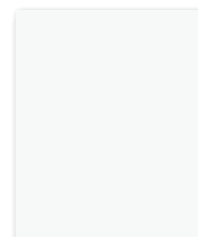

WAAKB104 **WAAKB000**
○ 360 l m² ○ 360 l m²
matt | **V1** glossy | **V1**

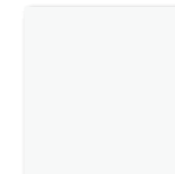

WAAG6104 **WAAG6000**
○ 360 l m² ○ 360 l m²
matt | **V1** glossy | **V1**



WARKB104 **WARKB000**
○ 350 l m² ○ 350 l m²
relief matt | **V2** relief glossy | **V2**



WARG6104 **WARG6000**
○ 370 l m² ○ 370 l m²
relief matt | **V2** relief glossy | **V2**



25x33
20x25

weiß | white

Produkt product	cm	mm	EN	St/m ²	kg/m ²	kg/m ²	kg/m ²	kg/m ²	kg/m ²	kg/m ²	kg/m ²
Wandfliese wall tile	40x120	398-1198x10	EN 14411 - L BIII	3	2,1	1,44	21	30,24	29,0	20,1	633
Wandfliese wall tile*	30x90	298-898x10	EN 14411 - L BIII	4	3,7	1,08	30	32,40	20,0	18,5	625
Wandfliese wall tile**	30x90	298-898x8	EN 14411 - L BIII	5	3,7	1,35	30	40,50	20,0	14,8	625
Wandfliese wall tile	30x60	298-598x8	EN 14411 - L BIII	8	5,56	1,44	40	57,60	21,3	14,8	876
Wandfliese wall tile	20x60	198-598x10	EN 14411 - L BIII	9	8,3	1,08	42	45,36	20,0	18,5	865
Wandfliese wall tile	20x40	198-398x7	EN 14411 - L BIII	20	12,5	1,60	48	76,80	20,6	12,9	1 016
Wandfliese wall tile	25x33	250-330x7	EN 14411 - L BIII	18	12	1,50	54	81,00	18,6	12,4	1 030
Wandfliese wall tile	20x25	198-248x6,8	EN 14411 - L BIII	30	20	1,50	60	90,00	17,6	11,7	1 078

* Verfügbar solange der Vorrat reicht | Available while stocks last

** Neues Produkt in 8 mm Stärke im Laufe des Jahres 2025 verfügbar | New product in 8 mm thickness available during 2025

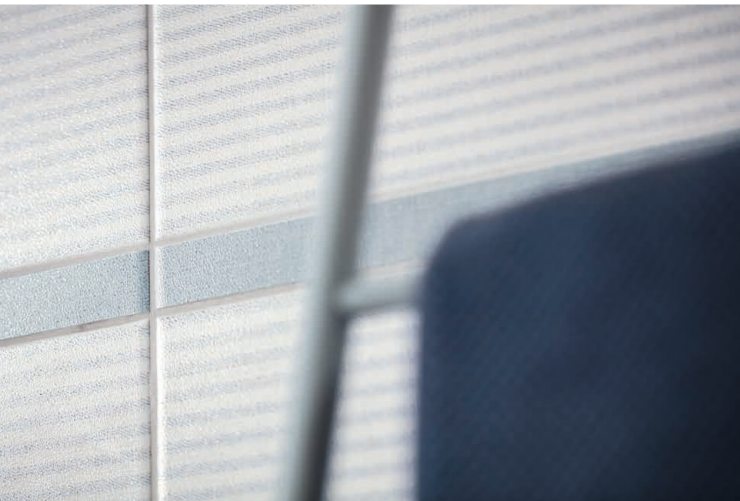

20x40

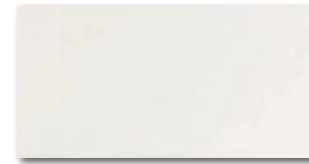

WADMB450
 ○ 400 l m²
 mattglossy | **V2**



WADMB451
 ○ 400 l m²
 mattglossy | **V2**



WADMB452
 ○ 400 l m²
 mattglossy | **V2**



WADMB456
 ○ 440 l m²
 mattglossy | **V2**



WADMB457
 ○ 440 l m²
 mattglossy | **V2**



WADMB458
 ○ 440 l m²
 mattglossy | **V2**

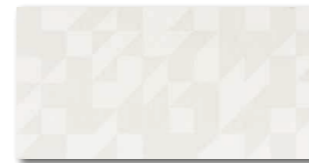

WADMB453
 ○ 440 l m²
 mattglossy | **V4**



WADMB454
 ○ 440 l m²
 mattglossy | **V4**



WADMB455
 ○ 440 l m²
 mattglossy | **V4**

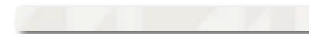

WLAMF453
 ○ 220 l St
 mattglossy



WLAMF454
 ○ 220 l St
 mattglossy



WLAMF455
 ○ 220 l St
 mattglossy

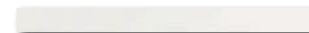

WLAMF450
 ○ 220 l St
 mattglossy



WLAMF451
 ○ 220 l St
 mattglossy
 rot | red



WLAMF452
 ○ 220 l St
 mattglossy
 blau | blue

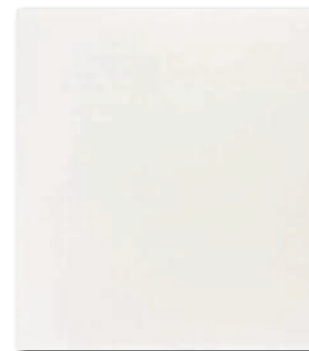

DAA4H050
 PEI 4 ○ 510 l m²
 matt

elfenbein | ivory

40x3

RAKO Home

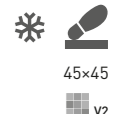

45x45
V2

Produkt | product



Produkt product	20x40	198x398x7	EN 14411 - L BIII	20	12,5	1,60	48	76,80	20,6	12,9	1 016
Wandfliese wall tile	40x3	398x31x7	EN 14411 - L BIII	12	-	0,14	-	-	-	-	-
Bordüre listel	45x45	448x448x8	EN 14411 - G Bla	6	5	1,21	34	41,14	21,1	17,4	741

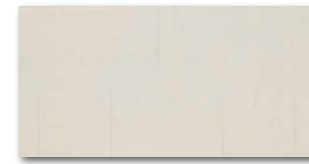

WADMB101
○ 420 | m²
matt



WADMB102
○ 420 | m²
matt



WADMB103
○ 420 | m²
matt



WADMB111
○ 440 | m²
matt



WADMB112
○ 440 | m²
matt



WADMB113
○ 440 | m²
matt

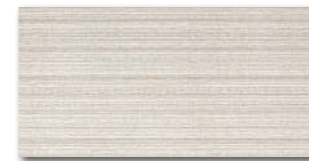

WITMB037
○ 390 | St
matt



WLAMH020
○ 250 | St
matt
lila | purple



WDM05101 [SHEET]
○ 250 | Netz
matt
elfenbein | ivory



WDM05102 [SHEET]
○ 250 | Netz
matt
beige | beige



WDM05103 [SHEET]
○ 250 | Netz
matt
braun | brown



20x40
v2



20x40
40x3,5

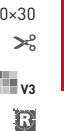

5x5 | 30x30
v3

Produkt | product

	cm	mm	EN	St/m ²	kg/m ²	kg/m ²	kg/m ²	kg/m ²	kg/m ²	kg/m ²	kg/m ²
Wandfliese wall tile (WADMB...)	20x40	198x398x7	EN 14411 - L BIII	20	12,5	1,60	48	76,80	20,6	12,9	1 016
Bordüre listel	40x2,2	398x22x7	EN 14411 - L BIII	6	113,6	0,05	-	-	1,0	17,1	-
Dekor decor	20x40	198x398x7	EN 14411 - L BIII	4	12,5	0,32	-	-	4,1	12,9	-
Bordüre listel	40x3,5	398x35x7	EN 14411 - L BIII	12	71,4	0,17	-	-	2,4	14,4	-
Mosaik set 30x30 cm mosaic sheet 30x30 cm	5x5	48x48x7	STO No. 030 - 059826	3/4	11	0,27/0,36	-	-	3,5/4,8	12,9	-

Wir empfehlen die Kombination mit den Fliesen der Serie Concept. | To combine with Concept floor tiles is recommended.

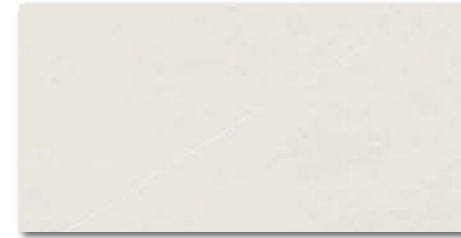

WADV622
 ○ 480 | m²
 matt | **V3**
 hellgrau | light grey

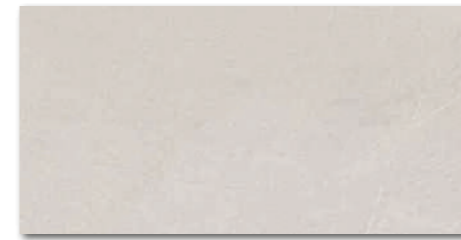

WADV623
 ○ 480 | m²
 matt | **V3**
 grau | grey



WADV626
 ○ 480 | m²
 matt | **V4**
 grau | grey



WADV624
 ○ 480 | m²
 matt | **V3**
 dunkelgrau | dark grey



WDM05622 (SHEET)
 ○ 250 | Netz
 matt
 hellgrau | light grey



WDM05623 (SHEET)
 ○ 250 | Netz
 matt
 grau | grey

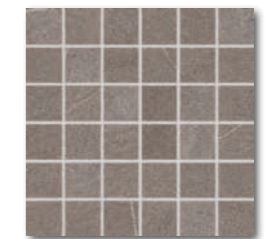

WDM05624 (SHEET)
 ○ 250 | Netz
 matt
 dunkelgrau | dark grey

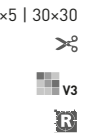

Produkt | product



Wandfliese wall tile	30×60	298×598×8	EN 14411 - L BIII	8	5,56	1,44	40	57,60	21,3	14,8	876
Mosaik set 30×30 cm mosaic sheet 30×30 cm	5×5	48×48×8	STO No. 030 - 059826	4	11	0,36	-	-	5,2	14,8	-

Die Produktverpackung enthält zufällige Designmöglichkeiten. | The products are deliberately mixed in packing to include a random selection of designs.

Wir empfehlen die Kombination mit den Fliesen der Serie Quarzit. | To combine with Quarzit floor tiles is recommended.

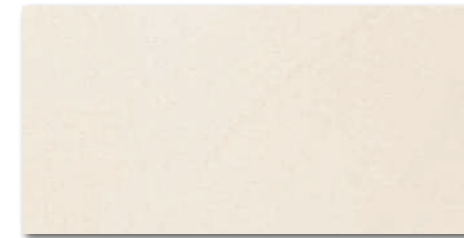

WADV620
 ○ 480 | m²
 matt | **V3**
 hellbeige | light beige

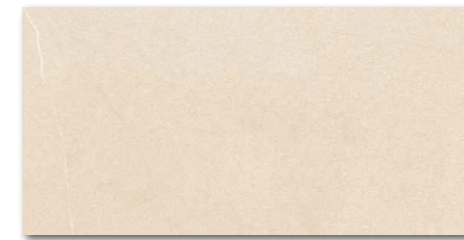

WADV621
 ○ 480 | m²
 matt | **V3**
 beige | beige

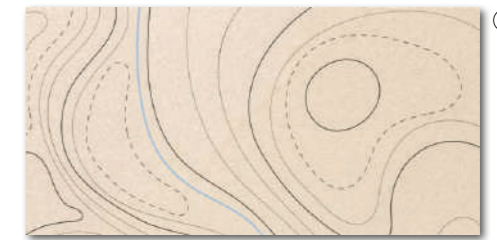

WADV625
 ○ 480 | m²
 matt | **V4**
 beige | beige



Die Fliesen der Serie zeichnen sich durch ein breites Farbspiel V3 | V4 aus. | All products of the entire batch show big deviations in shade difference V3 | V4.

Wir empfehlen, einzelne Fliesen aus mehreren Paketen herauszunehmen und den gesamten Bodenbelag nach der Inspirationsfotodokumentation in den Katalogen RAKO, eventuell den Webseiten www.rako.eu, zu komponieren. Wünschenswert ist die Kombination aller Fliesendesigns einschließlich ihrer Drehung um 180°, sodass ausgewogene Optik der verlegten Fläche erzielt wird.

Before laying the tiles, we suggest you select from several cartons and arrange them as illustrated in the inspiration photo documentation in RAKO catalogues or website www.rako.eu, and mix the tiles to achieve the required result including turning them by 180°.



WDM05620 (SHEET)
 ○ 250 | Netz
 matt
 hellbeige | light beige



WDM05621 (SHEET)
 ○ 250 | Netz
 matt
 beige | beige



Produkt product	30x60	298x598x8	EN	8	5,56	1,44	40	57,60	21,3	14,8	876
Wandfliese wall tile	30x60	298x598x8	EN 14411 - L BIII	8	5,56	1,44	40	57,60	21,3	14,8	876
Mosaik set 30x30 cm mosaic sheet 30x30 cm	5x5	48x48x8	STO No. 030 - 059826	4	11	0,36	-	-	5,2	14,8	-

Die Produktverpackung enthält zufällige Designmöglichkeiten. | The products are deliberately mixed in packing to include a random selection of designs.

Wir empfehlen die Kombination mit den Fliesen der Serie Quarzit. | To combine with Quarzit floor tiles is recommended.

30x60
V2

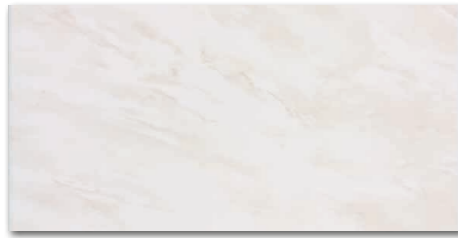

WADV K150
○ 480 l m²
matt

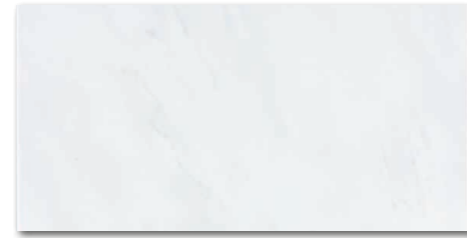

WADV K050
○ 480 l m²
glossy

WADV K151
○ 480 l m²
matt

WADV K051
○ 480 l m²
glossy

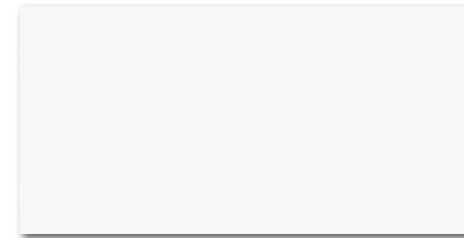

WAKVK000
○ 480 l m²
glossy | V1
weiß | white

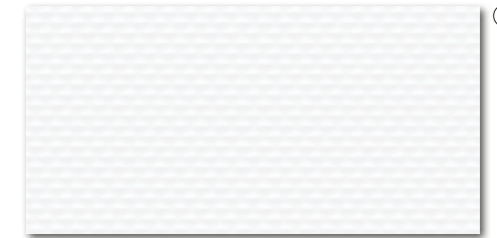

WR3VK000
○ 500 l m²
relief glossy | V2

30x60
60x2,3
R

25x33
20x25
V2



WATKB101
○ 350 l m²
matt
beige | beige

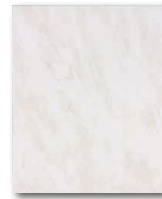

WATG6025
○ 300 l m²
matt



WATKB100
○ 350 l m²
matt
grau | grey



WATG6024
○ 300 l m²
matt



WAKVK508
○ 500 l m²
glossy | V2
hellbeige | light beige

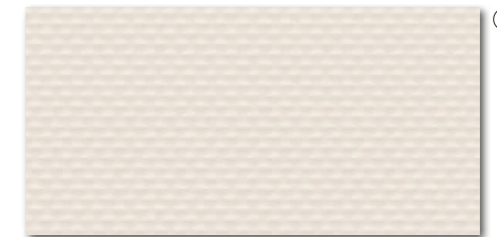

WR3VK508
○ 500 l m²
relief glossy | V2

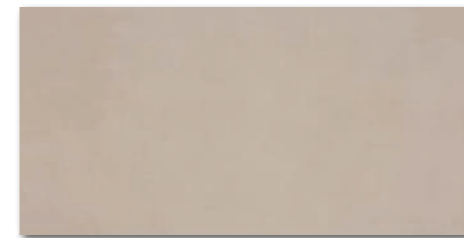

WAKVK509
○ 500 l m²
glossy | V2
grau-braun | grey-brown

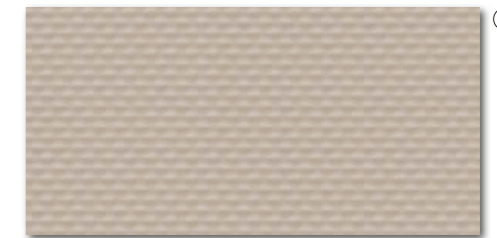

WR3VK509
○ 500 l m²
relief glossy | V2

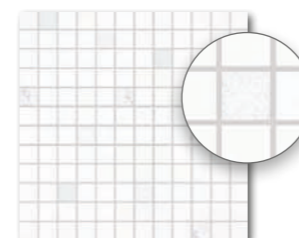

WDM02000* (SHEET)
○ 760 l Netz
glossy
weiß | white

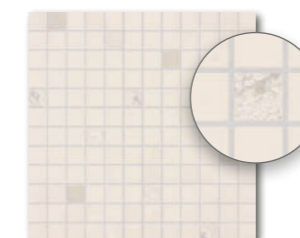

WDM02508* (SHEET)
○ 760 l Netz
glossy
hellbeige | light beige

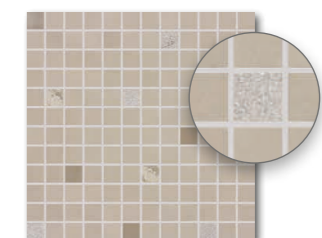

WDM02509* (SHEET)
○ 760 l Netz
glossy
grau-braun | grey-brown

2,5x2,5 | 30x30
V3
R

Produkt product	cm	mm	EN	Stk/m ²	Stk/m ²	Stk/m ²	Stk/m ²	Stk/m ²	Stk/m ²	kg/m ²	kg/m ²
Wandfliese wall tile	30x60	298x598x8	EN 14411 - L BIII	8	5,56	1,44	40	57,60	21,3	14,8	876
Wandfliese wall tile	20x25	198x248x6,8	EN 14411 - L BIII	30	20	1,50	60	90,00	17,6	11,7	1 078
Wandfliese wall tile	25x33	250x330x7	EN 14411 - L BIII	18	12	1,50	54	81,00	18,6	12,4	1 030
Wandfliese wall tile	30x60	298x598x8	EN 14411 - L BIII	8	5,56	1,44	40	57,60	21,3	14,8	876
Mosaik set 30x30 cm mosaic sheet 30x30 cm	2,5x2,5	23x23x10	STO No. 030 - 059826	3	11	0,27	-	-	4,4	18,5	-

* Verfügbar solange der Vorrat reicht | Available while stocks last

ⓘ Um das optimale Effekt zu erreichen, empfehlen wir die Verlegung in einer Richtung. | For optimal effect, the laying of individual tiles in one direction is recommended.

Wir empfehlen die Kombination mit den Fliesen der Serie Extra. | To combine with Extra floor tiles is recommended.

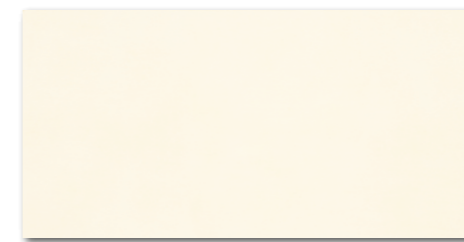
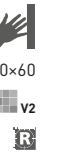

WAKVK510
 ○ 500 | m²
 glossy | V2

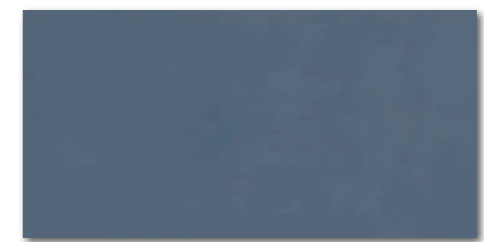

WAKVK511
 ○ 500 | m²
 glossy | V2

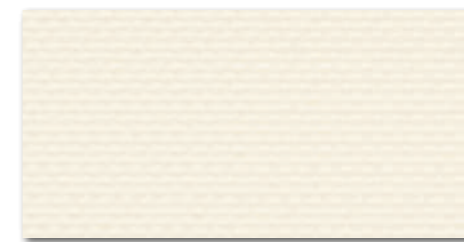

WR3VK510
 ○ 500 | m²
 relief glossy | V2

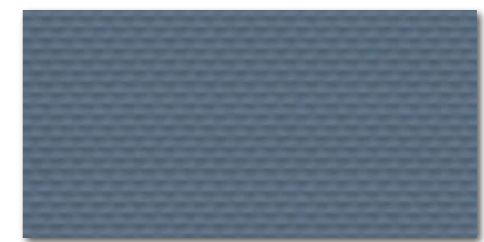

WR3VK511
 ○ 500 | m²
 relief glossy | V2

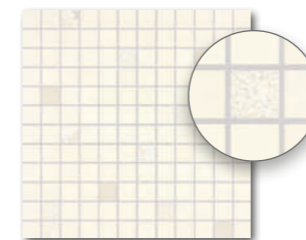

WDM02510* (SHEET)
 ○ 760 | Netz
 glossy
 elfenbein | ivory

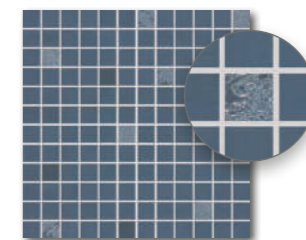

WDM02511* (SHEET)
 ○ 760 | Netz
 glossy
 dunkelblau | dark blue



Produkt | product

Wandfliese wall tile	30×60	298×598×8	EN 14411 - L BIII	8	5,56	1,44	40	57,60	21,3	14,8	876
Mosaik set 30×30 cm mosaic sheet 30×30 cm	2,5×2,5	23×23×10	STO No. 030 - 059826	3	11	0,27	-	-	4,4	18,5	-

* Verfügbar solange der Vorrat reicht | Available while stocks last

ⓘ Um das optimale Effekt zu erreichen, empfehlen wir die Verlegung in einer Richtung. | For optimal effect, the laying of individual tiles in one direction is recommended.

Wir empfehlen die Kombination mit den Fliesen der Serie Extra. | To combine with Extra floor tiles is recommended.

20x40

20x40

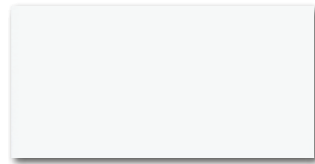

WAAMB000
○ 390 | m²
glossy | V1

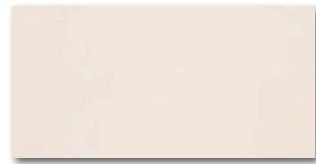

WADMB508
○ 440 | m²
glossy | V2

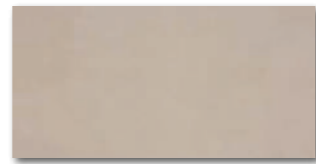

WADMB509
○ 440 | m²
glossy | V2

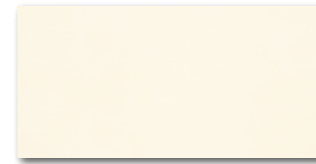

WADMB510
○ 440 | m²
glossy | V2

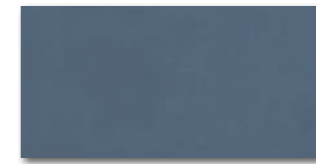

WADMB511
○ 440 | m²
glossy | V2



WADMB513
○ 580 | m²
relief glossy | V4
mehrfarbig | multicoloured



WADMB512
○ 580 | m²
glossy | V4
mehrfarbig | multicoloured



WITMB000
○ 300 | St
mattglossy



WITMB509
○ 300 | St
mattglossy



WITMB510
○ 300 | St
mattglossy



WITMB511
○ 300 | St
mattglossy

40x4,5

40x4,5



WLAMH000
○ 220 | St
mattglossy



WLAMH508
○ 220 | St
mattglossy



WLAMH510
○ 220 | St
mattglossy



WLAMH511
○ 220 | St
mattglossy

40x2

40x2



WLRMG000*
○ 220 | St
glossy

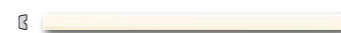

WLRMG510*
○ 220 | St
glossy



WLRMG511*
○ 220 | St
glossy

5x5 | 30x30

5x5 | 30x30

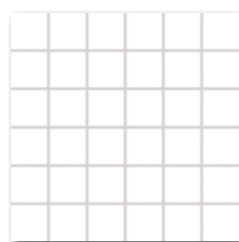

WDM05000 (SHEET)
○ 250 | Netz
glossy | V1
weiß | white

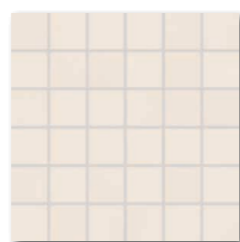

WDM05508 (SHEET)
○ 250 | Netz
glossy | V2
hellbeige | light beige

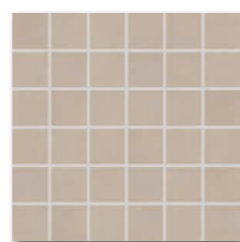

WDM05509 (SHEET)
○ 250 | Netz
glossy | V2
grau-braun | grey-brown



WDM05510 (SHEET)
○ 250 | Netz
glossy | V2
elfenbein | ivory

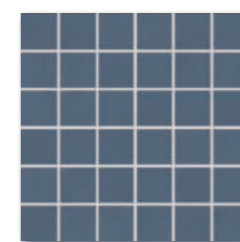

WDM05511 (SHEET)
○ 250 | Netz
glossy | V2
dunkelblau | dark blue

Produkt product	cm	mm	EN	Stk/m ²	Stk/m ²	Stk/m ²	Stk/m ²	Stk/m ²	Stk/m ²	kg/m ²	kg/m ²
Wandfliese wall tile	20x40	198-398x7	EN 14411 - L BIII	20	12,5	1,60	48	76,80	20,6	12,9	1 016
Dekor decor (WITMB...)	20x40	198-398x7	EN 14411 - L BIII	8	12,5	0,64	-	-	8,3	12,9	-
Bordüre listel	40x4,5	398-45x7	EN 14411 - L BIII	10	55,6	0,18	-	-	2,3	12,9	-
Bordüre relief listel	40x2	398x20	STO No. 030 - 060753	12	125	0,10	-	-	1,8	18,8	-
Mosaik set 30x30 cm mosaic sheet 30x30 cm	5x5	48-48x7	STO No. 030 - 059826	3/4	11	0,27/0,36	-	-	3,5/4,8	12,9	-

* Verfügbar solange der Vorrat reicht | Available while stocks last

Die Produktverpackung enthält zufällige Designmöglichkeiten. | The products are deliberately mixed in packing to include a random selection of designs.

Wir empfehlen die Kombination mit den Fliesen der Serie Extra, Pino und Plank. | To combine with Extra, Pino und Plank floor tiles is recommended.





60x120

R10/B

v3



DAKV1846*
DAKV9846**
 PEI 5 ○ 700 l m²
 matt
 color **fog**
 grau-weiß | grey-white



DAKV1847*
DAKV9847**
 PEI 4 ○ 700 l m²
 matt
 color **natural**
 grau | grey

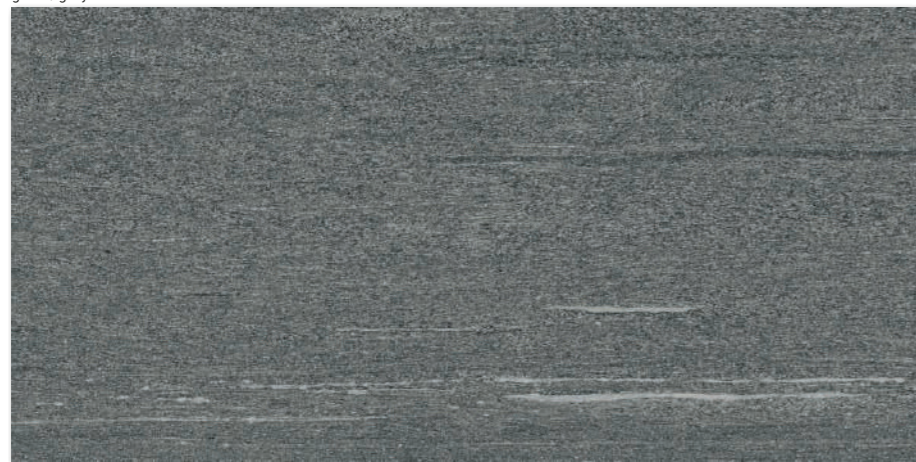

DAKV1848*
DAKV9848**
 PEI 4 ○ 700 l m²
 matt
 color **pepper**
 dunkelgrau | dark grey



60x60

60x15/10/5

R10/B

v3



DAK62846
 PEI 5 ○ 560 l m²
 matt
 color **fog**
 grau-weiß | grey-white



DAK62847
 PEI 4 ○ 560 l m²
 matt
 color **natural**
 grau | grey

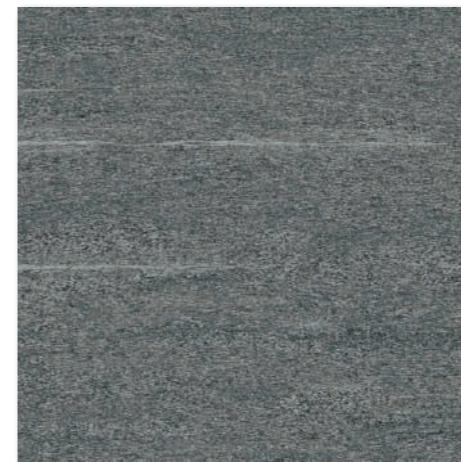

DAK62848
 PEI 4 ○ 560 l m²
 matt
 color **pepper**
 dunkelgrau | dark grey



DAKSV846
 PEI 5 ○ 1250 l m²
 matt



DAKSV847
 PEI 4 ○ 1250 l m²
 matt

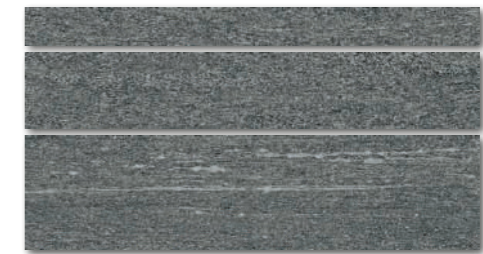

DAKSV848
 PEI 4 ○ 1250 l m²
 matt

* Verfügbar solange der Vorrat reicht | Available while stocks last | ** Neues Produkt in 9 mm Stärke im Laufe des Jahres 2025 verfügbar | New product in 9 mm thickness available during 2025

ⓘ Die Verpackung enthält 5 Stück von jedem Format. | The product is packed with 5 pieces of each format.



DDM05846 (SHEET)
PEI 5 ○ 300 | Netz
matt
color **fog**
grau-weiß | grey-white



DDM05847 (SHEET)
PEI 4 ○ 300 | Netz
matt
color **natural**
grau | grey

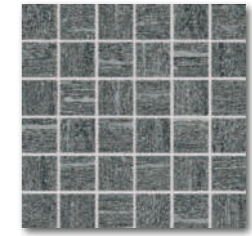

DDM05848 (SHEET)
PEI 4 ○ 300 | Netz
matt
color **pepper**
dunkelgrau | dark grey

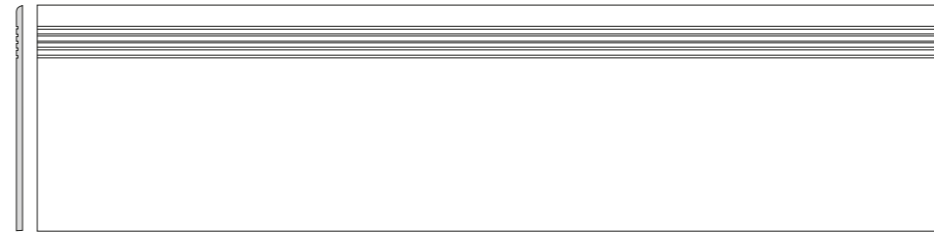

DCPVF846* | DCPVD846** color **fog** | grau-weiß | grey-white
DCPVF847* | DCPVD847** color **natural** | grau | grey
DCPVF848* | DCPVD848** color **pepper** | dunkelgrau | dark grey
PEI 4-5 ○ 740 | St
matt

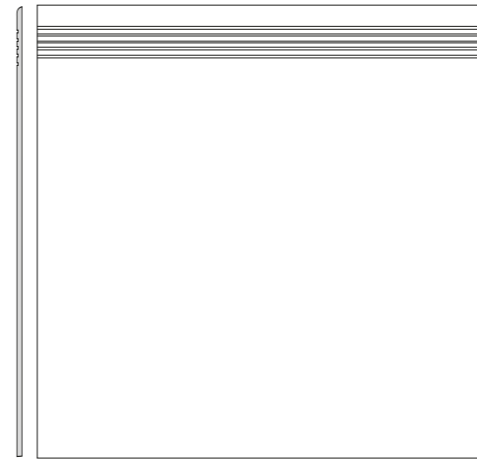

DCP62846 color **fog** | grau-weiß | grey-white
DCP62847 color **natural** | grau | grey
DCP62848 color **pepper** | dunkelgrau | dark grey
PEI 4-5 ○ 370 | St
matt



DSAS3846 color **fog** | grau-weiß | grey-white
DSAS3847 color **natural** | grau | grey
DSAS3848 color **pepper** | dunkelgrau | dark grey
○ 180 | St
matt

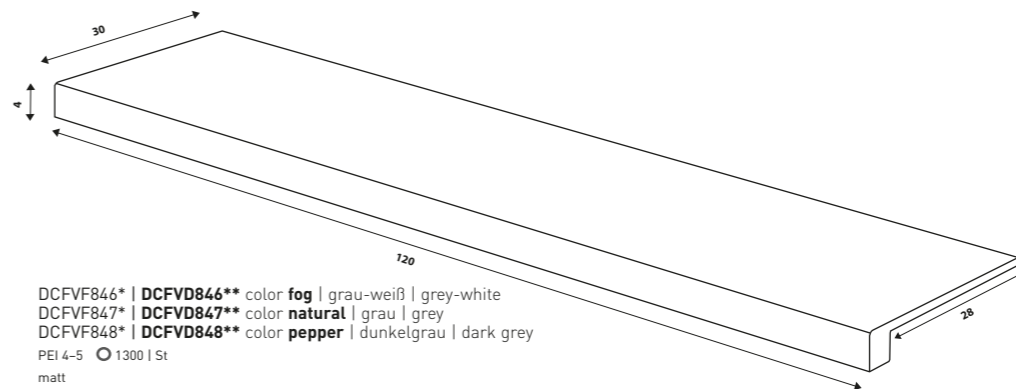

DCFVF846* | DCFVD846** color **fog** | grau-weiß | grey-white
DCFVF847* | DCFVD847** color **natural** | grau | grey
DCFVF848* | DCFVD848** color **pepper** | dunkelgrau | dark grey
PEI 4-5 ○ 1300 | St
matt

* Verfügbar solange der Vorrat reicht | Available while stocks last

** Neues Produkt in 9 mm Stärke im Laufe des Jahres 2025 verfügbar | New product in 9 mm thickness available during 2025



5x5 | 30x30



R10/B



v3



30x120

R10/B



v3



60x60

R10/B



v3



60x7,2



30x120

R10/B



v3



Die Fliesen der Serie zeichnen sich durch ein breites Farbspiel V3 aus. | All products of the entire batch show big deviations in shade difference V3.

Wir empfehlen, Fliesen aus verschiedenen Paketen zu entnehmen und den kompletten Bodenbelag gemäß der Inspirationsfotodokumentation in den RAKO-Katalogen oder auf den Websites www.rako.eu aufzulegen. Wir empfehlen zwei Verlegungsmethoden: die Verlegung aller Fliesen in einer Richtung oder die Schachbrettverlegung mit regelmäßiger 90°-Drehung.

Before laying the tiles, we suggest you select from several cartons and arrange them as illustrated in the inspiration photo documentation in RAKO catalogues or website www.rako.eu. There are two recommended laying patterns to choose from: one is a strictly one-way oriented design, and the other resembles a chessboard look achieved through a regular 90° turn tiling pattern.

Produkt product	cm	mm	EN	Stim²	kg/m²	kg	kg	kg	kg	kg	kg	kg
Bodenfliese floor tile*	60x120	598x1198x10	EN 14411 - G Bia	2	1,4	1,44	27	38,88	32,7	22,7	908	
Bodenfliese floor tile**	60x120	598x1198x9	EN 14411 - G Bia	2	1,4	1,44	30	43,20	29,3	20,4	905	
Bodenfliese floor tile	60x60	598x598x9	EN 14411 - G Bia	4	2,8	1,44	32	46,08	29,1	20,2	955	
Bodenfliese floor tile	60x15/10/5	598x148/98/48x9	EN 14411 - G Bia	15	16,7	0,90	36	32,4	18,2	20,2	679	
Mosaik 30x30 cm mosaic sheet 30x30 cm	5x5	48x48x9	EN 14411 - G Bia	3	11	0,27	-	-	5,2	19,2	-	
Stufe step tile*	30x120	298x1198x10	EN 14411 - G Bia	3	2,8	1,08	-	-	24,6	-	-	
Stufe step tile**	30x120	298x1198x9	EN 14411 - G Bia	3	2,8	1,08	-	-	22,5	-	-	
Stufe step tile	60x60	598x597x9	EN 14411 - G Bia	3	2,8	1,08	-	-	21,9	-	-	
Sockel skirting plinth	60x7,2	598x72x9	EN 14411 - G Bia	14	23,1	0,60	-	-	11,5	-	-	
Stufenformteil special step tile	30x120	298x1198x10	STO No. 030 - 059824	2	-	-	-	-	20,5	-	-	
Stufenformteil special step tile**	30x120	298x1198x9	STO No. 030 - 059824	2	-	-	-	-	-	-	-	

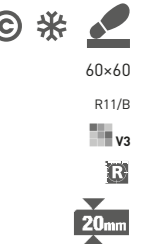

DAR66846
PEI 5 ○ 760 l m²
relief matt
color **fog**
grau-weiß | grey-white



DAR66847
PEI 4 ○ 760 l m²
relief matt
color **natural**
grau | grey

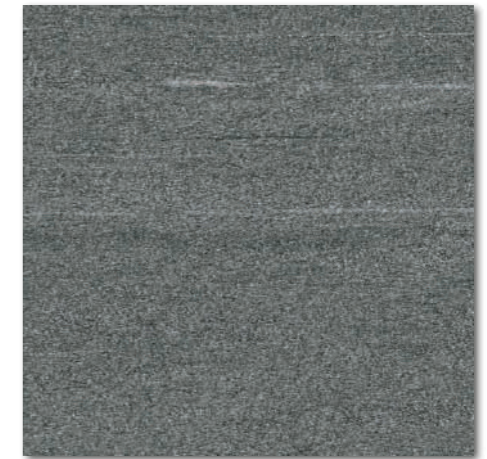

DAR66848
PEI 4 ○ 760 l m²
relief matt
color **pepper**
dunkelgrau | dark grey

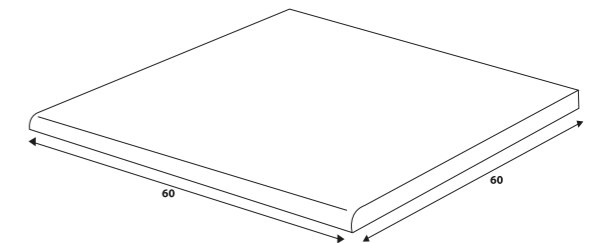

DCH66846 color **fog** | grau-weiß | grey-white
DCH66847 color **natural** | grau | grey
DCH66848 color **pepper** | dunkelgrau | dark grey
PEI 4-5 ○ 780 l St
relief matt

Produkt | product

Bodenfliese | floor tile
Stufe | step tile



60×60

60×60

598×598×20

598×598×20

EN 14411 - G Bla

EN 14411 - G Bla

2

2

2,8

-

0,72

-

30

-

21,6

-

32,5

32,5

45,1

-

999

-

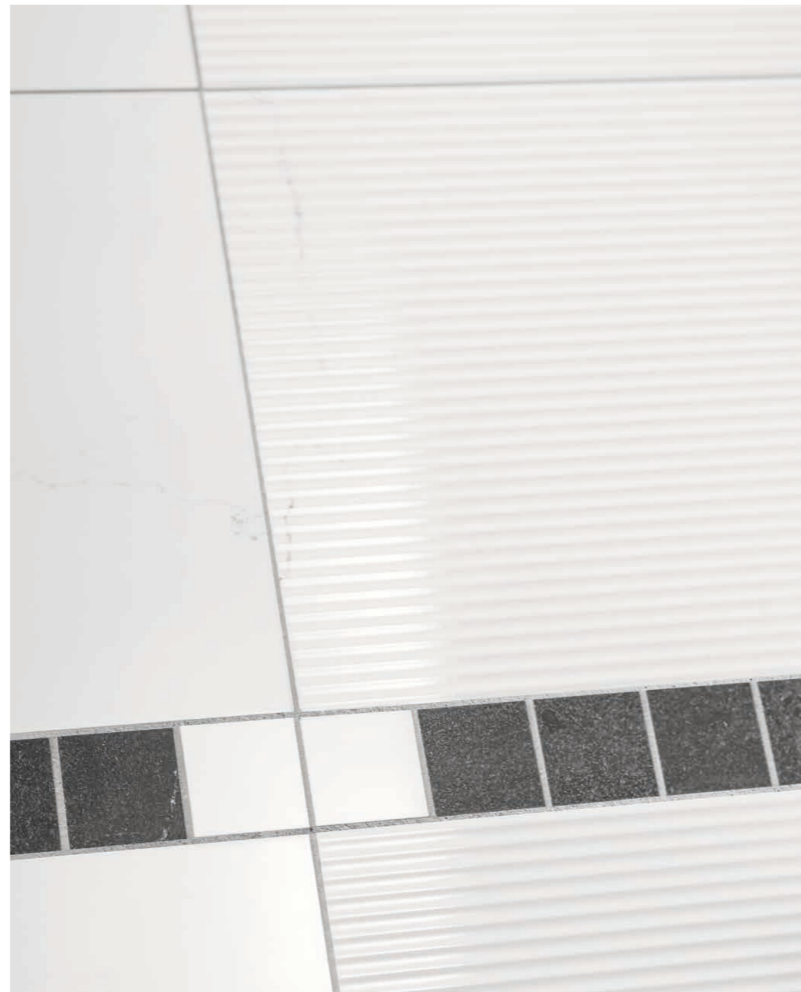



Die Fliesen der Serie zeichnen sich durch ein breites Farbspiel V3 aus. | All products of the entire batch show big deviations in shade difference V3.

Wir empfehlen, einzelne Fliesen aus mehreren Paketen herauszunehmen und den gesamten Bodenbelag nach der Inspirationsfotodokumentation in den Katalogen RAKO, eventuell den Webseiten www.rako.eu, zu komponieren. Wünschenswert ist die Kombination aller Fliesendesigns einschließlich ihrer Drehung um 180°, sodass ausgewogene Optik der verlegten Fläche erzielt wird.

Before laying the tiles, we suggest you select from several cartons and arrange them as illustrated in the inspiration photo documentation in RAKO catalogues or website www.rako.eu, and mix the tiles to achieve the required result including turning them by 180°.



WAKV5233
○ 710 l m²
matt

WAKV5133
○ 710 l m²
glossy



WAKVK233
○ 500 l m²
matt

WAKVK133
○ 500 l m²
glossy



WARVK233
○ 500 l m²
relief matt
weiß | white

WARVK133
○ 500 l m²
relief glossy

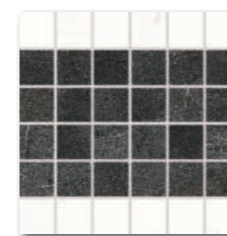

WDM05233
○ 250 l Netz
matt

weiß-schwarz | white-black

WDM05133
○ 250 l Netz
mattglossy



WDR05233
○ 320 l Netz
relief matt

weiß | white

WDR05133
○ 320 l Netz
relief glossy

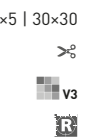

Produkt product	cm	mm	EN	Stk/m ²	Stk	kg	kg/m ²	brutto kg
Wandfliese wall tile	30x90	298-898-10	EN 14411 - L BIII	4	3,7	1,08	30	32,40
Wandfliese wall tile	30x60	298-598-8	EN 14411 - L BIII	8	5,56	1,44	40	57,60
Mosaik set 30x30 cm mosaic sheet 30x30 cm (WDM...)	5x5	48-48x8	STO No. 030 - 059826	4	11	0,36	-	-
Mosaik set 30x30 cm mosaic sheet 30x30 cm (WDR...)	5x5	48-48x8	STO No. 030 - 059826	4	11	0,36	-	-

Wir empfehlen die Kombination mit den Fliesen der Serie Quarzit. | To combine with Quarzit floor tiles is recommended.

Empfohlene Formatkombinationen siehe Seite 522-523. | Recommended combinations of modular sizes see pages 522-523.



DAR34710
PEI 5 ○ 390 | m²
relief matt



DAR34711
PEI 4 ○ 390 | m²
relief matt



DAR34712
PEI 4 ○ 390 | m²
relief matt



DAR34713
PEI 4 ○ 390 | m²
relief matt



DDM05710 (SHEET)
PEI 5 ○ 300 | Netz
relief matt
hellbeige | light beige



DDM05711 (SHEET)
PEI 4 ○ 300 | Netz
relief matt
grau | grey

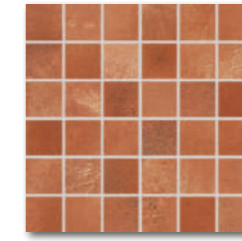

DDM05712 (SHEET)
PEI 4 ○ 300 | Netz
relief matt
rot-braun | red-brown

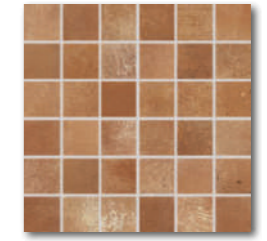

DDM05713 (SHEET)
PEI 4 ○ 300 | Netz
relief matt
braun | brown



DDVT8710 (SHEET)
PEI 5 ○ 460 | Netz
relief matt
hellbeige | light beige



DDVT8711 (SHEET)
PEI 4 ○ 460 | Netz
relief matt
grau | grey

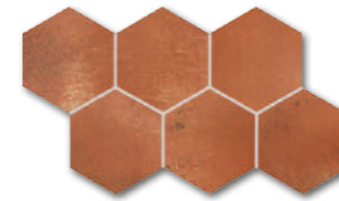

DDVT8712 (SHEET)
PEI 4 ○ 460 | Netz
relief matt
rot-braun | red-brown



DDVT8713 (SHEET)
PEI 4 ○ 460 | Netz
relief matt
braun | brown

30x30
R9/A
v4

5x5 | 30x30
R10/B
v4

21x37
R9/A
v4

RAKO Home

Produkt product	cm	mm	EN	St/m ²	kg/m ²	St/m ²	kg/m ²	St/m ²	kg/m ²	St/m ²	kg/m ²
Bodentiese floor tile	30x30	298x298x8	EN 14411 - G Bla	13	11	1,18	48	56,64	20,5	17,4	1 011
Mosaik set 30x30 cm mosaic sheet 30x30 cm	5x5	48x48x8	EN 14411 - G Bla	3/4	11	0,27/0,36	-	-	4,7/6,2	17,4	-
Dekor decor	12/7	120/70x8	EN 14411 - G Bla	5	13,1	0,38	-	-	6,6	17,4	-



Technische
Informationen

Technical
information

A white semi-circular graphic containing the RAKO logo (the word 'RAKO' in white on a red background), the tagline 'Complete Ceramic Solution', and three technical icons: a square, a magnifying glass, and a target symbol. A small yellow square is located at the bottom left of the graphic.

RAKO
Complete Ceramic Solution

2025

DE Empfehlungen für den Einsatz keramischer Fliesen von RAKO:

Feinsteinzeugfliesen mit den Katalognummern Dxxxxxxx, Gxxxxxxx, Txxxxxxx, sind trockenengepresste keramische Belagselemente mit einer Wasseraufnahme $E \leq 0,5\%$, hergestellt nach EN 14411 BlA GL/UGL. Die Erzeugnisse können universell als Boden- und Wandfliesen im Außen- und Innenbereich eingesetzt werden, wo sie Witterungseinflüssen, hoher mechanischer Beanspruchung sowie Verschmutzung ausgesetzt sind. Oberflächen mit entsprechend angeführten rutschhemmenden Eigenschaften sind für Fußböden gemäß den einschlägigen Vorschriften zu verwenden. Für Böden mit Rutschgefahr sind keramische Fliesen mit deklarierter Rutschfestigkeit gemäß den einschlägigen Normen und Vorschriften zu verwenden. Fliesen und deren Zubehör (Mosaik, Dekor, Sockel, Treppenfliesen usw.), die im Katalog mit einem Symbol **R** gekennzeichnet sind, sind rektifiziert, d. h. nach dem Brand auf Maß geschliffen, mit einer Garantie des angegebenen Maßes in Form des sog. Kalibers. Bei den rektifizierten Produkten sind auch andere geometrische Eigenschaften verbessert, wie die Geradheit der Kanten oder die Rechtwinkligkeit, und sie ermöglichen eine präzise Verlegung mit einer minimalen Fuge von 2 mm, sowie eine Kombination von Formaten.

Wandfliesen (Steingut) mit der Katalognummer Wxxxxxxx sind glasierte keramische Belagselemente mit einer Wasseraufnahme $E > 10\%$, hergestellt nach EN 14411 BlII GL. Sie sind für die Wandbeläge in Innenräumen vorgesehen, die nicht den Witterungseinflüssen, Frost, dauerhafter Wassereinwirkung, Säuren und Laugen, deren Dämpfen und der Wirkung abrasiver Mittel ausgesetzt werden. Deshalb werden sie für Wandbeläge in Bädern, Küchen, Wäschereien und sonstigen Innenbereichen eingesetzt. **Im Bereich, wo die Steingutfiese der direkten Wassereinwirkung ausgesetzt wird, wie beispielsweise in einer Dusche usw., ist eine Fugenmasse des Typs CG2WA mit reduzierter Wasseraufnahme zu verwenden.** Die Oberfläche der Fliesen kann mit glatter oder Reliefstruktur, mit matter, halbmatter oder glänzender Glasur ausgeführt werden. In Abhängigkeit vom verwendeten Typ der Glasur (transparent, halbtransparent) kann nicht ausgeschlossen werden, dass eine vorübergehende geringfügige Verfärbung der Oberfläche durch Montagebedingte Feuchtigkeit auftreten kann. Ein ähnlicher Effekt kann durch in Fugen eindringende Feuchtigkeit entstehen. Diese vorübergehende Verfärbung stellt jedoch keinen Produktfehler dar. Großformatige Fliesen (30 × 60, 30 × 90 und 40 × 120 cm) werden auch in kalibrierter Ausführung produziert. Außer der garantierten genauen Abmessung (Kalibers) verfügen sie über weitere verbesserte geometrische Eigenschaften (Kantengeradheit, Rechtwinkligkeit), die eine präzise Verlegung ermöglichen.

Glasierete Fliesen mit der Katalog Nr. GARJDxxx sind trockenengepresste keramische Belagselemente mit einer Wasseraufnahme von $0,5\% < E \leq 3\%$, hergestellt nach EN 14 411 BlB GL, Anhang H. Die Erzeugnisse können für die Wandbeläge von Innenwänden und Aussenfassaden, die der Witterung ausgesetzt sind, verwendet werden. Beispiele für ihren universellen Einsatz sind Wände von Bädern, Küchen, Fluren, Büros, Aussenfassaden, Saunen, Duschen, Schwimmbädern sowie öffentliche Gebäude und Lebensmittelverarbeitungsbetriebe. Die Fliesen werden in einer breiten Farbpalette mit glänzender, reliefartiger Oberfläche hergestellt. Aufgrund der geringeren mechanischen Widerstandsfähigkeit der glänzenden Glasur sind diese Produkte nicht für Bodenbeläge geeignet.

Nicht keramische Ergänzungsmaterialien - Glas mit der Katalognummer Vxxxxxxx stellen eine geeignete einzigartige Ergänzung keramischer Beläge dar. Die Eigenschaften dieser Materialien und die charakteristischen Unterschiede in Farbe, Struktur und in weiteren Eigenschaften sind durch die Produktionstechnologie oder durch ihre natürliche Herkunft gegeben.

Glasierete, stranggepresste Feinsteinzeugfliesen und -formstücke POOL mit der Katalognummer XPxxxxxx sind dicht gesinterte, keramische, glasierte, frostbeständige Belagselemente mit sehr niedriger Wasseraufnahme $E \leq 0,5\%$, hergestellt durch Strangpressen nach EN 14411 Ala GL. Sie sind die perfekte Lösung für die Ausgestaltung von öffentlichen und privaten Schwimmbädern im Innen- und Außenbereich.

Produktbezeichnung - Produktionscharge

Alle keramischen Belagselemente entstehen in einzelnen Chargen, die sich durch Farbton und Abmessungen unterscheiden können. Deshalb sind sie in der Begleitdokumentation, auf Paletten und Lieferscheinen extra ausgewiesen. Die Kennzeichnung der Verpackung beinhaltet außer der Katalognummer, des Namens der Serie, eventuell des Typs der Oberfläche oder des Erzeugnisses, den Farbton, das Werkmaß, das Kaliber, die Sortierung und den EAN-Code. Fliesen aus Chargen mit abweichend bezeichnetem Farbton oder mit abweichenden Werkmaßen dürfen nicht für dieselbe Fläche verwendet werden. Der Farbton ist auf der Verpackung durch die Kombination von zwei oder drei Buchstaben und Nummern gekennzeichnet. Die Abmessung ist durch einen Nummerncode in mm angegeben (8 bedeutet die letzte Zahl ab der angegebenen Größe z.B. 598 × 598 × 9 mm).

Bild 1. **Kennzeichnung von Farbton, Größe, Qualität auf Karton und Palette**
Fig. 1 **Identification of the colour shade, size, quality, and typology (GL or UGL) is printed on a cardboard packaging and on a pallet.**

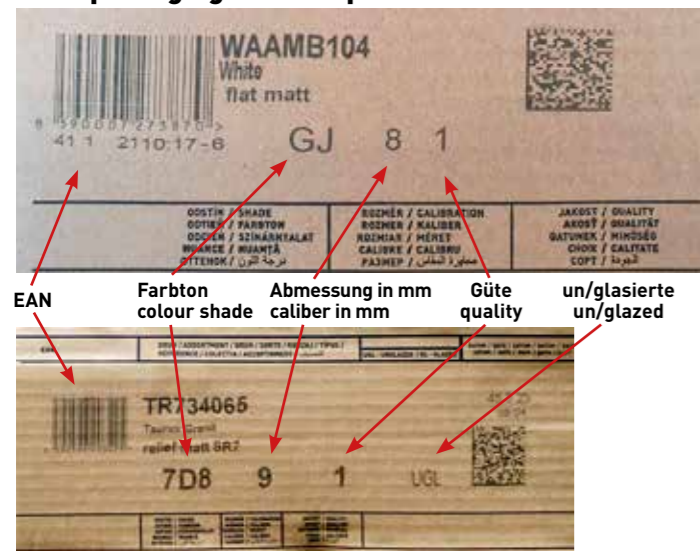

Vor der Fliesenverlegung sind die Angaben über die gelieferten Chargen auf den Verpackungen zu prüfen. Please check the markings on the packaging before laying to verify if the tiles you purchased for one area have the same batch, colour shade, size and quality.

Zertifizierung und Leistungserklärung

Prüfung der Beständigkeit und der Eigenschaften der keramischen Belagselemente wird entsprechend der Anordnung des Europäischen Parlaments und des EU-Rates Nr. 305/2011 vom 9. 3. 2011, Beurteilungssystem 4, durchgeführt. Die Herstellererklärungen sind in verschiedenen Sprachen unter www.rako.eu erhältlich.

EN Recommended use of available types of ceramic tiles RAKO:

Fully vitrified floor tiles with catalogue codes Dxxxxxxx, Gxxxxxxx, Txxxxxxx
Fully vitrified dry-pressed frost-resistant ceramic tiles with very low water absorption $E \leq 0.5\%$, made in compliance with EN 14411 BlA GL/UGL. The products are intended mainly for floor tiling exteriors and interiors exposed to climatic effects and subjects to extreme mechanical stress, abrasion and pollution. The tiles with declared anti-slip surface finish must be used for floors with the risk of slipping pursuant to the applicable regulations. The products marked with **R** icon are rectified and besides the accurate dimensions (calibre), they also have improved geometrical parameters (linearity, rectangularity), allowing precise laying with a joint of 2 mm at minimum and format combinations.

Wall tiles with a catalogue code Wxxxxxxx
Ceramic dry-pressed glazed wall tiles with water absorption $E > 10\%$, made in compliance with EN 14411 BlII GL. They are designed for tiling of interior walls and not suitable for exposure to climatic effects, frost, permanent effects of water, acids and alkali, their vapours and abrasives. **In environments where porous wall tiles will be exposed to the direct action of water, in shower boxes etc., it is necessary to use a CG2WA type grouting material with reduced water absorption.** With respect to used glaze typology (transparent, semi-transparent), transient dark colouring of the tile may appear, as it is influenced by humidity penetrating into the body of the tile. The colouring may further be supported with water permeability of the joints, insulation layers in the base (water is held between the insulation layer and the glaze), and high air humidity in bathrooms with insufficient ventilation. However, this transient colouring does not represent a defect of the product. Large-format wall tiles (30 × 60, 30 × 90 and 40 × 120 cm) are manufactured also in a rectified design. In addition to accurate dimensions (calibre), they also have improved geometrical parameters (linearity, rectangularity), allowing precise laying with a joint of 2 mm at minimum and format combinations.

Glazed tiles with catalogue code GARJDxxx
are dry-pressed ceramic tile elements with a water absorption of $0.5\% < E \leq 3\%$ manufactured according to EN 14 411 BlB GL, Annex H. The tiles can be used to clad interior walls and exterior facades that are exposed to the weather. Examples of their universal use are walls of bathrooms, kitchens, corridors, offices, external facades, saunas, showers, swimming pools and public buildings and food processing plants. The tiles are produced in a wide range of colours with a glossy surface in relief. These products are not intended for flooring due to the reduced mechanical resistance of the glossy glaze.

Non-ceramic accessory materials - glass with a catalogue code Vxxxxxxx
Unique accessory materials complementing ceramic wall tiles. Properties of these materials and their characteristic differences in colour, structure and other properties are determined by the production technology or by their natural origin.

POOL vitrified extruded elements and special pieces, catalogue code: XPxxxxxx
Highly vitrified extruded glazed frost-resistant ceramic products with very low absorption $E \leq 0.5\%$, in compliance with EN 14411 Ala GL. They are suitable mainly for professional solutions of large public swimming pools as well as for private indoor and outdoor swimming pools.

Product identification - production batches

All ceramic tile products are made in batches which may differ from each other in colour shade and dimensions. The batches are identified in client documentation, on pallets, cardboard boxes and in delivery notes. In addition to the catalogue number, name of the series and the type of surface or product, packages include identification of shade, declared dimensions, calibre, quality, glazed or unglazed typology and EAN code. Tiles from individual batches with different identification of the colour shade or declared size shall not be used in the same area. The colour shade on the cardboard packaging is marked with a combination of two or three characters, and the size is indicated as a code number in mm (e.g. 8 refers to work size of e.g. 598 × 598 × 9 mm)

Certifications and Declarations of performance

Systems for assessing and verifying stability of structural products' properties:
System 4 annex V point 1.5 Regulation of the European parliament and the Commission (EU) No. 305/2011 dated 9th March 2011
Declarations of performance are available to download in several languages at: www.rako.eu.

Produktverpackung

Die Produkte werden in Papierkartons verpackt und auf EUR-Holzpalette (120 × 80 cm) gelagert. Fliesen mit 120 × 120 cm werden auf einer Holzpalette mit seitlicher Verlängerung (122 × 122 × 70 cm) mit Kunststoffbändern befestigt und in Plastikfolie eingewickelt.

Completion of products

Products are packed in paper cartons, placed on a wooden EUR pallet (120 × 80 cm), and floor tiles 120 × 120 cm on a wooden pallet with sides (122 × 122 × 70 cm), fixed with plastic tapes and protected with plastic foil.

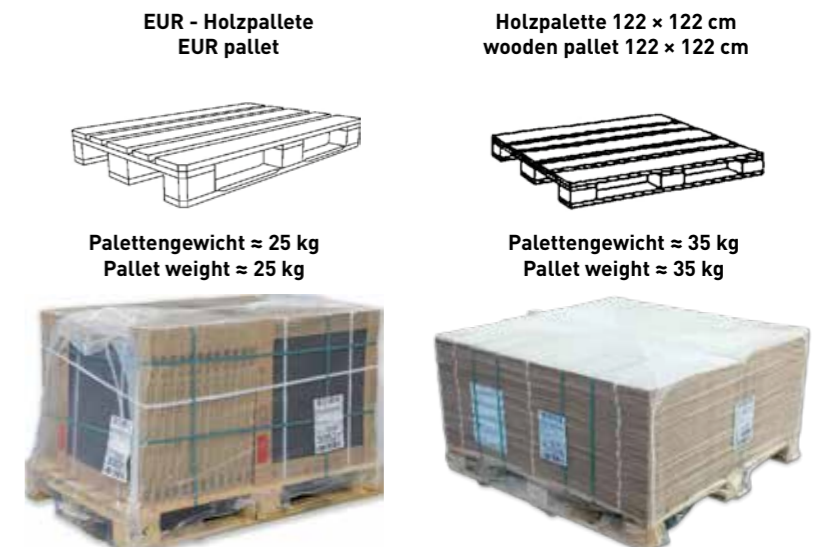

FR Utilisation recommandée des types proposés des éléments de revêtements céramiques:

Les carreaux céramiques pleinement vitrifiés, numéros de catalogue Dxxxxxxx, Gxxxxxxx, Txxxxxxx

sont des éléments de revêtement céramiques pressés à sec à faible absorption d'eau $E \leq 0,5\%$ fabriqués selon EN 14411 B1a GL/UGL. Les produits ont une utilisation universelle comme un dallage ou un revêtement des intérieurs et des extérieurs où ils sont exposés aux effets climatiques, à un haut effort mécanique ou un encrassement. Les surfaces avec un antidérapage déclaré doivent être utilisées pour les sols présentant un danger de glissement selon les règlements respectifs. Les carreaux et accessoires (mosaïques, décors, plinthes, marches etc.) marquée d'une icône **R** sont rectifiés. En plus de garantir une dimension exacte (le calibre), ils possèdent également des propriétés géométriques améliorées (bords droits, orthogonalité), permettant une pose précise et des calepinages de formats.

Les faïences de revêtement, numéro de catalogue: Wxxxxxxx

sont des revêtements céramiques émaillés pressés à sec à absorption d'eau $E > 10\%$ fabriqués selon EN 14411 BIII GL. Elles sont conçues pour le revêtement des murs intérieurs qui ne sont pas exposés aux intempéries, au gel, aux effets permanents de l'eau, aux acides et aux alcalis, à leurs vapeurs ni aux effets abrasifs. **Dans l'ambiance où un carreau poreux sera exposé à l'action direct de l'eau (par exemple: dans le cabinet de douche etc.), on recommande d'utiliser le matériel à jointoyer CG2WA avec l'absorption réduite, par exemple le matériel à jointoyer GF.** Selon le type de vernis (transparent, semi-transparent), une coloration foncée temporaire de la faïence, conditionnée par sa structure, ne peut être exclue, étant causée par la pénétration de l'humidité dans le fragment du carreau. La coloration peut être en outre favorisée par la perméabilité à l'eau des joints, des couches isolantes dans le fond (l'eau restera renfermée entre la couche isolante et la glaçure) et une humidité de l'air élevée dans les salles de bains avec une ventilation insuffisante. Toutefois, cette coloration temporaire ne représente pas un défaut du produit. Les faïences grand format (30 x 60, 30 x 90 et 40 x 120 cm) sont également fabriquées dans une version rectifiée. En plus de garantir des dimensions exactes (le calibre), elles possèdent d'autres propriétés géométriques optimisées (bords droits, orthogonalité) permettant une pose précise.

Les carreaux émaillés avec le code de catalogue GARJDXxx

sont des éléments de carreaux céramiques pressés à sec avec une absorption d'eau de $0,5\% < E \leq 3\%$, fabriqués conformément à la norme EN 14411 B1b GL, annexe H. Les carreaux peuvent être utilisés pour revêtir les murs intérieurs et les façades extérieures exposés aux intempéries. Les murs des salles de bains, des cuisines, des couloirs, des bureaux, des façades extérieures, des saunas, des douches, des piscines, des bâtiments publics et des usines de transformation des aliments sont des exemples de leur utilisation universelle. Les carreaux sont produits dans une large gamme de couleurs avec une surface brillante en relief. Ces produits ne sont pas destinés aux revêtements de sol en raison de la résistance mécanique réduite de l'émail brillant.

Matériaux accessoires non céramiques – verre avec un numéro de catalogue Vxxxxxxx

sont des accessoires uniques convenables des revêtements céramiques. Les propriétés de ces matériaux et des différences caractéristiques en couleur, structure et d'autres qualités sont déterminées par la technologie de la fabrication ou par leur origine naturelle.

Carreaux frittés vernis extrudés et agglomérés POOL, numéro de catalogue: XPxxxxxx

Se sont des éléments hautement frittés, vernis céramiques, résistants au gel avec absorption d'eau $E \leq 0,5\%$, fabriqués par une extrusion selon EN 14411 A1a GL. Ils conviennent à une solution professionnelle de bords de piscines publiques et privés dans les intérieurs et les extérieurs.

Marquage des produits - lots de production

Tous les éléments de revêtement céramiques sont fabriqués dans les dosages – les lots qui peuvent différer les uns des autres en fonction d'une nuance et/ou d'une dimension. Les différents lots sont désignés dans la documentation ci-jointe, sur les palettes et les bordereaux de livraison. Sur les emballages sont indiqués, outre le numéro de catalogue, le nom de la série et, le cas échéant, le type de surface ou le type de produit, la nuance, la dimension déclarée, le calibre, la qualité et le code EAN.

Les éléments de revêtement de différents lots avec une nuance distinctement désignée du lot ou une dimension distinctement déclarée ne doivent pas être utilisés pour une surface. La nuance est désignée sur les cartons par une combinaison de deux ou trois lettres et les chiffres, la dimension est indiquée par un code numérique, voir la fig. 1.

Fig. 1 Identification sur carton et sur palette

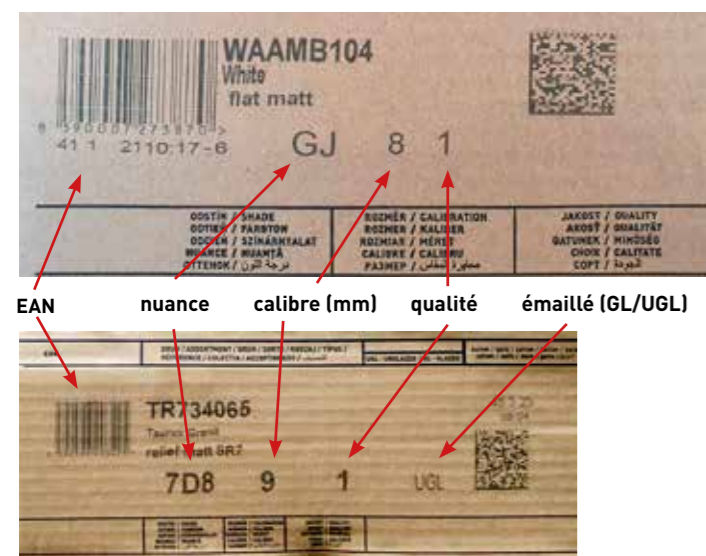

EAN nuance calibre (mm) qualité émaillé (GL/UGL)



Avant le commencement des travaux de revêtement, il faut vérifier les données sur les emballages.

Certification et déclaration des caractéristiques

La vérification de la stabilité des caractéristiques des éléments de revêtement céramiques réalisée selon le Règlement du Parlement européen et du Conseil de l'UE No. 305/2011 du 9. 3. 2011, système de l'évaluation 4. Les déclarations du fabricant sont disponibles en plusieurs langues sur www.rako.eu.

DE Nenn- und Werkmaß:

Keramische Belagelemente werden gem. EN 14411 mit **Nennabmessungen** in cm gekennzeichnet, z. B. 10 x 10, 20 x 20 cm. Die jeweilige hergestellte Abmessung – Werkmaß (W) – des keramischen Elements wird auf der Verpackung in mm angegeben. Das Verfahren zur Bestimmung der geometrischen Parameter der keramischen Belagelemente und der zulässigen Abweichungen von den Werkmaßen wird in der Norm EN ISO 10545-2 beschrieben. Die Werkmaße werden auf den Verpackungen und in Lieferscheinen in mm angegeben. Sollwerte und Toleranzen für alle Produkttypen von LASSELSBERGER, s.r.o. werden in den Informationsanhängen der Kataloge RAKO OBJECT I HOME angeführt.

Rektifizierte Belagelemente

Fliesen mit geringer Wasseraufnahme werden in den Abmessungen von 10 x 10, 20 x 20, 22,5 x 45, 22,5 x 22,5, 45 x 45, 15 x 60, 30 x 60, 60 x 60, 20 x 80, 40 x 80, 80 x 80, 20 x 120, 30 x 120, 60 x 120 und 120 x 120 cm und Verkleidungen mit 30 x 60, 30 x 90 und 40 x 120 cm angeboten. Die Kanten dieser Produkte werden geschliffen. Die Produkte sind in den Katalogen und Unterlagen mit diesem Symbol R (zde přijde ta ikona R) gekennzeichnet. **R**. Das bedeutet, dass die Belagelemente mit sehr geraden Kanten und mit einer sehr hohen Winkelgenauigkeit ausgeführt werden. Daher kann die Verlegung mit einer Fugenbreite ab 2mm erfolgen. Die Arbeiten müssen sehr sorgfältig ausgeführt werden, weil die geschliffenen Kanten sehr empfindlich sind.

Nicht rektifizierte Belagelemente

Nicht rektifizierte Belagelemente in der Reihe ColorTWO und TAURUS aus dem Katalog RAKO OBJECT werden überwiegend in den Modulabmessungen 8 gefertigt. Daneben werden nicht rektifizierte Wandfliesen in den Modulabmessungen 8 im Format 20 x 40, 20 x 60 und 30 x 60 und nicht rektifizierte Bodenfliesen im Format 10 x 10, 20 x 20, 10 x 30, 10 x 20, 30 x 30, 45 x 45 und 30 x 60 cm hergestellt. **Bei den nicht rektifizierten Belagelementen, einschließlich Sonderelementen, spielt das auf der Verpackung angeführte Werkmaß, für die Passgenauigkeit der unterschiedlichen Elemente eine entscheidende Rolle. Wegen den natürlichen Abmessungsungenauigkeiten bei nicht rektifizierten Produkten ist jedoch eine Verlegung mit Fugen unter 2 mm nicht empfehlenswert. Normgerechte Abmessungsunterschiede sind bei einer sehr schmalen Fuge erkennbar. Daher empfehlen wir bei der Verlegung von nicht rektifizierten Belagelementen eine Fugenbreite von ca. 3–4 mm.**

Modulabmessungen

Modulabmessungen, z. B. M 10 x 10, M 20 x 20 cm, sind zum Kombinieren von Belagelementen mit verschiedenen Formaten in eine Fläche bei der Einhaltung von durchlaufenden Fugen geeignet. Z. B. bei der Abmessung 8 (598 x 598, 298 x 598 mm) ist die Möglichkeit gegeben, die angegebenen Formate geschliffener (in Lappato-Ausführung) und standardmäßiger Bodenfliesen bzw. rektifizierter Wandfliesen in einer Fläche bei gleicher Fuge in Modulen zu kombinieren. **Fugen von weniger als 2 mm mindern die Fähigkeit, Spannungen zwischen dem Fußboden und den Fliesen zu absorbieren. Eine fugenlose Verlegung ist grundsätzlich nicht zu empfehlen. Diese Art der Verlegung schließt den Abbau der Spannung zwischen Untergrund und Fliesen vollständig aus, außerdem ist der in die Fugen eingedrungene Schmutz nicht zu entfernen.** Keramische Produkte mit Modulabmessungen werden durch ein Vielfaches der Grundabmessung gebildet. In die Produktabmessung ist auch die Breite der einheitlichen Fuge eingerechnet, sodass es möglich ist, eine regelmäßige Verlegung auch auf einer Fläche aus verschiedenen Formaten zu schaffen.

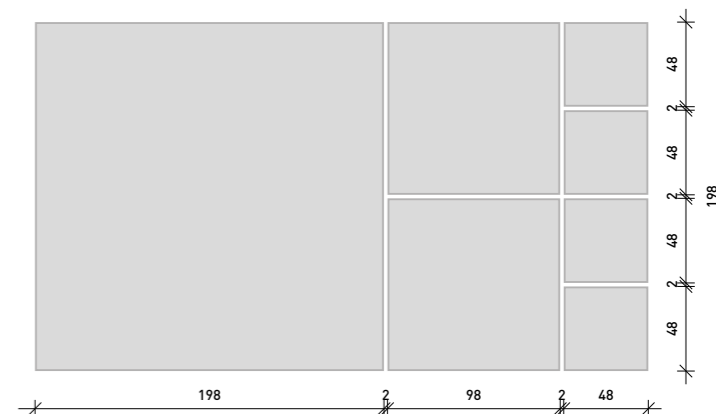

Mosaik, Dekore

Diese werden beispielsweise in den Nennabmessungen 2,5 x 2,5, 5 x 5, 5 x 10 cm u. ä. angeboten. **Die Abmessungen einzelner Arten von Mosaiken, Dekore und Sonderelementen werden von den Abmessungen der Grundformate abgeleitet.** Die einzelnen Elemente werden auf Kunststoff- oder Papiernetze aufgeklebt und mit Abmessungen von 30 x 30, 30 x 60 cm u. ä. ausgeliefert. Nach Bedarf können die Elemente durch Durchschneiden des Netzes zu Bändern oder Bordüren geformt werden oder die Größe der Sätze und der Fugen kann entsprechend den Umgebungselementen und großflächigen Bodenfliesen angepasst werden. Die zulässigen Abweichungen vom Werkmaß beschreiben die baulich technischen Vorschriften – STO, diese sind auch auf unserer Webseite www.rako.eu verfügbar.

EN Nominal and declared size:

Ceramic tiles are identified according to EN 14411 with **nominal sizes** in cm, for example: 10 x 10, 20 x 20 cm. Specific manufactured sizes – **declared dimensions (W)** of ceramic tiles are shown on packaging in mm. Methods to determine geometric parameters of ceramic tiles and allowed deviations from the declared sizes are described in the standard EN ISO 10545-2. The declared size is specified on packaging and delivery notes in millimetres. Accurate values and tolerance for all types of LASSELSBERGER, s.r.o. products are provided in information annexes to the catalogue RAKO OBJECT I HOME.

Rectified Tiles

Low-absorption floor tiles of sizes 10 x 10, 20 x 20, 22,5 x 45, 22,5 x 22,5, 45 x 45, 15 x 60, 30 x 60, 60 x 60, 20 x 80, 40 x 80, 80 x 80, 20 x 120, 30 x 120, 60 x 120 and 120 x 120 cm and wall tiles of sizes 30 x 60, 30 x 90 and 40 x 120 cm are mainly offered with rectified edges, which are ground with high precision and allow installation with a narrow joint from 2mm. In the catalogue, **rectified (ground) tiles are always marked with the letter R icon**. The ground edges of the rectified wall tiles and floor tiles are fragile and require careful and cautious handling.

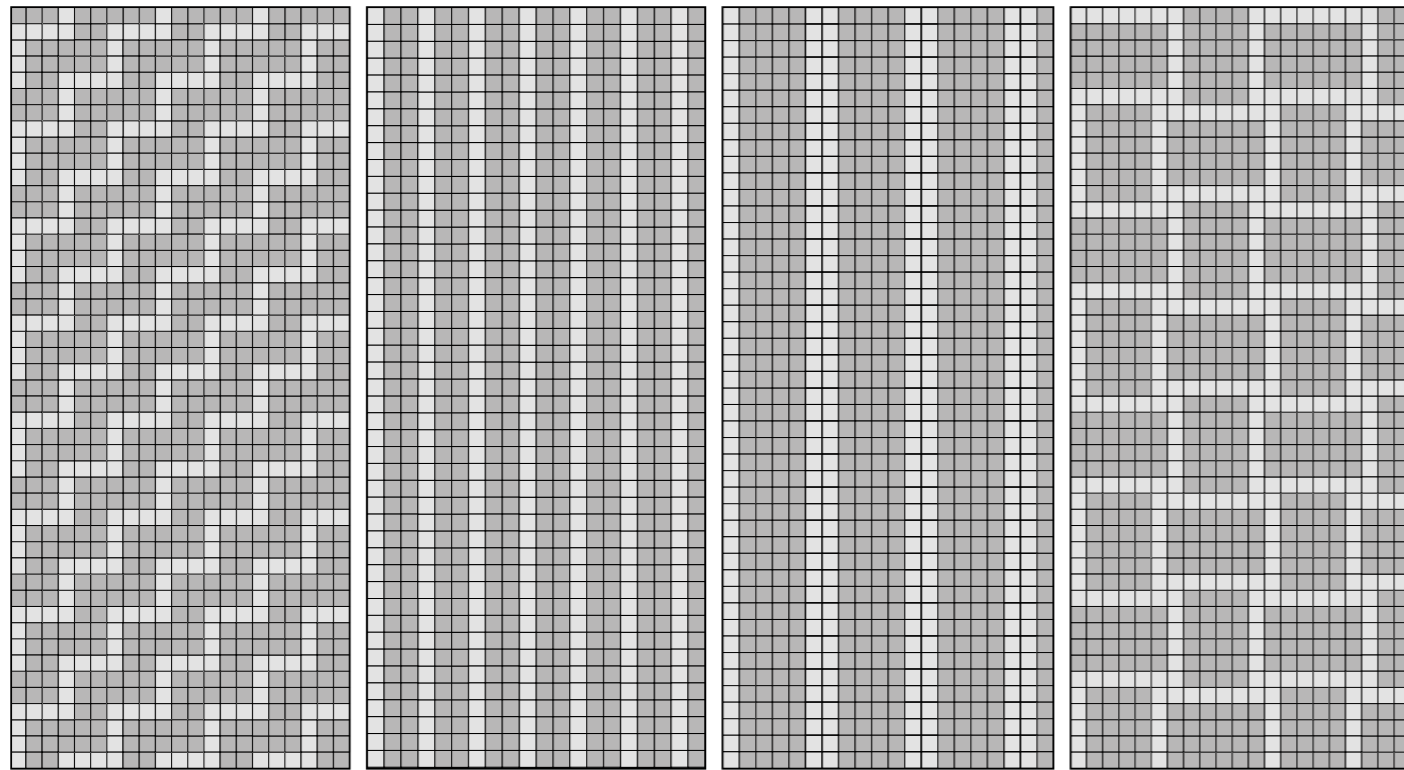

VEIN 5 x 5 | 30 x 30

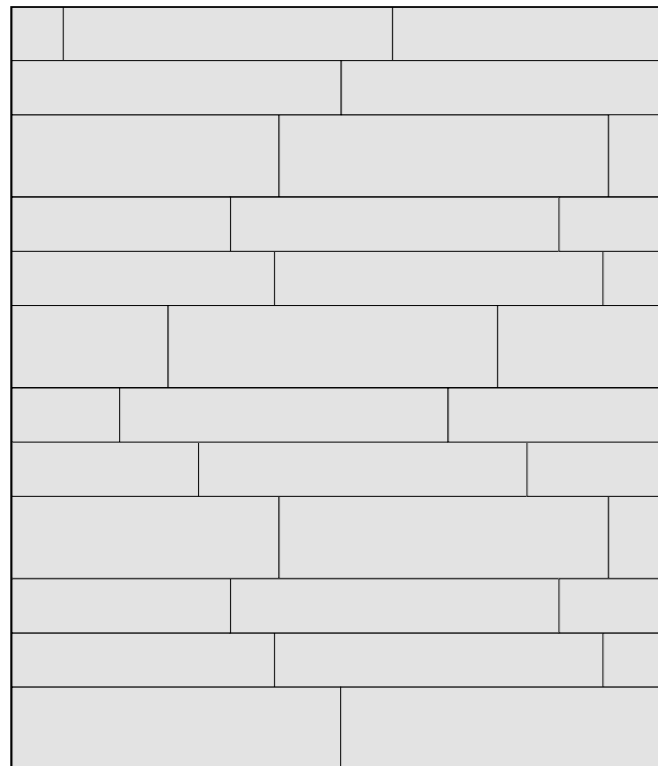

20 x 120 = 57%, 30 x 120 = 43%

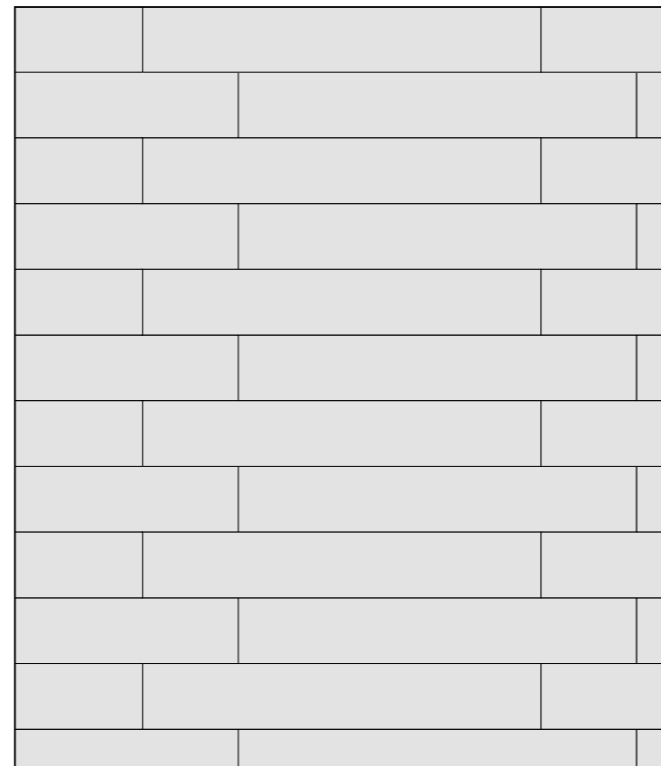

20 x 120 | 30 x 120 20 x 80 15 x 60

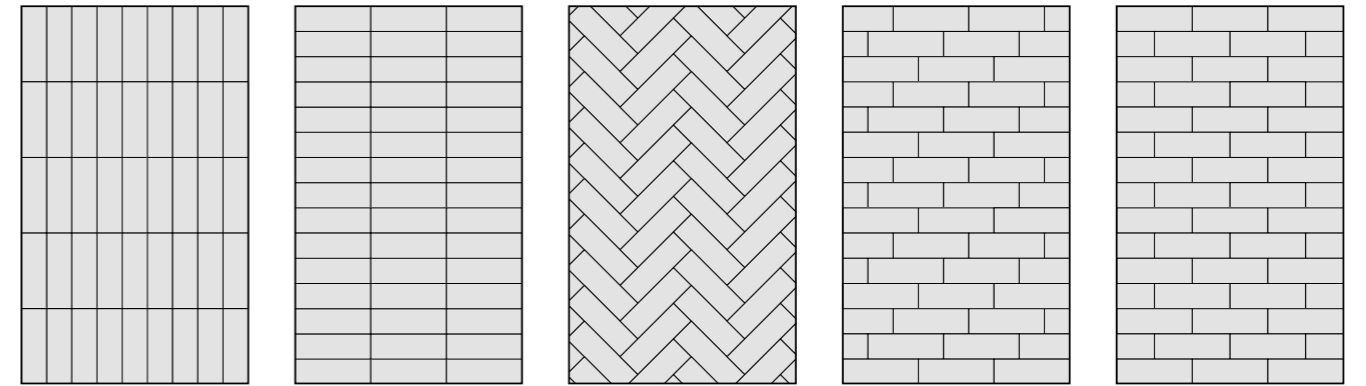

10 x 30
10 x 20

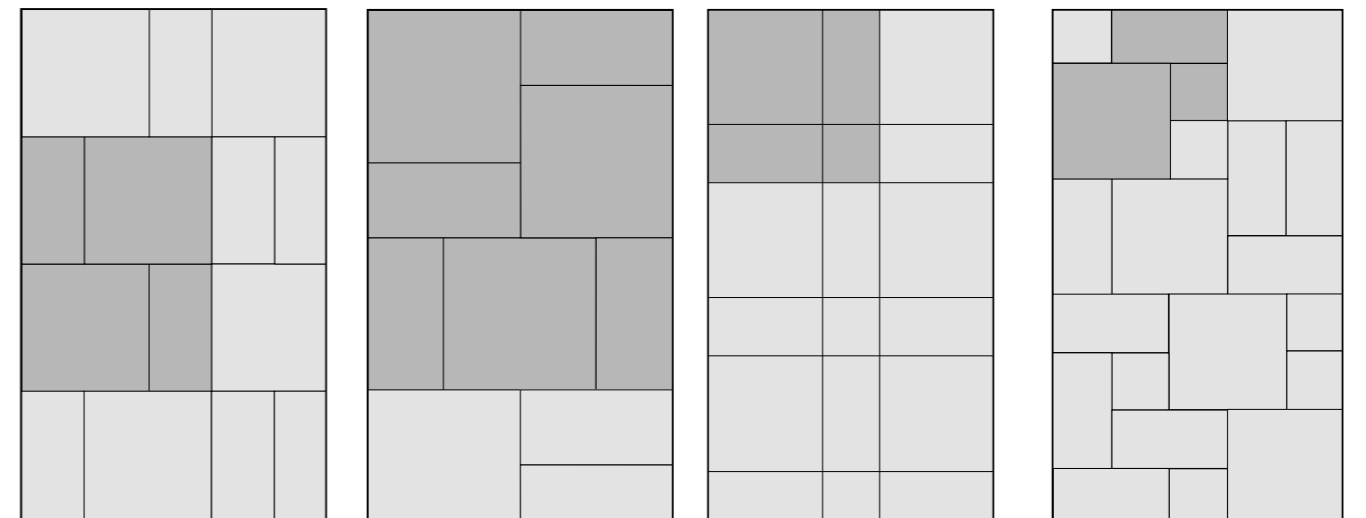

60 x 60 = 66,7%, 30 x 60 = 33,3%
80 x 80 = 66,7%, 40 x 80 = 33,3%
30 x 30 = 66,7%, 15 x 30 = 33,3%

60 x 60 = 60%, 30 x 60 = 40%
80 x 80 = 60%, 40 x 80 = 40%
30 x 30 = 60%, 15 x 30 = 40%

45 x 45 = 45%, 22,5 x 45 = 45%,
22,5 x 22,5 = 10%

45 x 45 = 57%, 22,5 x 45 = 29%,
22,5 x 22,5 = 14%

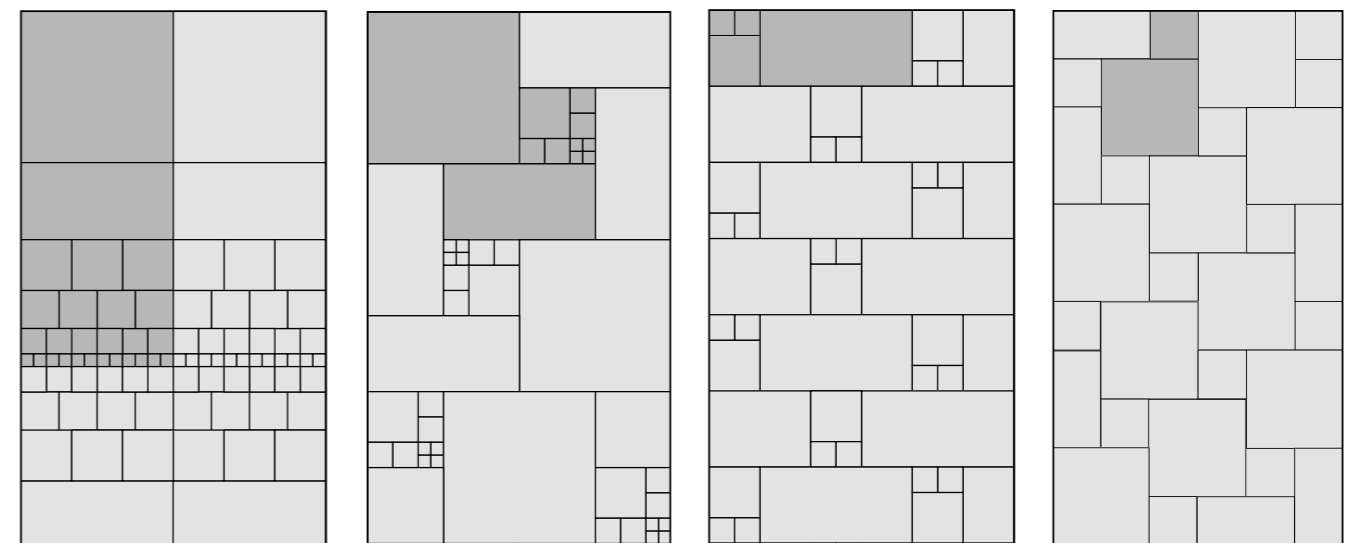

60 x 60 = 42,9%, 30 x 60 = 21,4%,
20 x 20 = 14,3%, 15 x 15 = 10,7%,
10 x 10 = 7,1%, 5 x 5 = 3,6%

60 x 60 = 57,1%, 30 x 60 = 28,6%,
20 x 20 = 6,3%, 10 x 10 = 6,3%,
5 x 5 = 1,7%

30 x 60 = 75%, 20 x 20 = 16,7%,
10 x 10 = 8,3%

45 x 45 = 80%, 22,5 x 22,5 = 20%



Abmessungen und geometrische Parameter | Sizes and geometric parameters Dimensions et paramètres géométriques

Non-rectified Tiles

Non-rectified tiles of the ColorTWO and TAURUS series included in the RAKO OBJECT catalogue are mostly produced in modular dimensions 8. In addition there are non-rectified wall tiles with module dimension 8 in the RAKO HOME catalogue in the sizes of 15 × 15, 20 × 20, 20 × 40, 20 × 60 and 30 × 60 and non-rectified floor tiles in the sizes of 10 × 10, 20 × 20, 10 × 30, 10 × 20, 30 × 30, 45 × 45 and 30 × 60 cm. **For non-rectified tile elements including special pieces, the decisive role is played by the declared dimensions of the product contained in the product batch, which are important when using several types of ceramic tile elements on one surface and for maintaining the same joint width. Owing to natural dimensional inaccuracies of the non-rectified products, we do not recommend installing tiles with a joint narrower than 2 mm. Dimensional differences in the case of very narrow joints are discernible in accordance with the standard. For this reason, in the case of installation of non-rectified tile elements we recommend a joint width of about 3-4 mm.**

Module sizes

Module sizes, e.g. M 10 × 10, M 20 × 20 cm, are suitable for combinations of tiles of different formats on one surface while keeping running joints. For example size 8 (598 × 598, 298 × 598 mm) allows modular combinations of these sizes of lapped and standard tiles or rectified tiles into a single surface with continuous joints. **However, joint widths narrower than 2 mm reduce the capability to absorb the tension between the base and the tile itself. As a rule, we do not recommend installation without joint spacing. This mode of installation completely eliminates the absorption of the tension between the base and the tile; moreover, the dirt that collects in the joints cannot be removed.** Ceramic products with module sizes consist of multiples of the basic sizes. The identification of the product size also includes the width of a uniform joint in order to achieve uniform joints on a surface made of different tile sizes.

Mosaics, decors

These are offered for example in nominal sizes 2.5 × 2.5, 5 × 5, 5 × 10 cm etc. **The sizes of the individual types of mosaic, decors and special pieces are derived from the basic tile sizes to which their dimensions are harmonised.** Individual elements are glued on plastic or paper mesh – sets in the sizes of 30 × 30, 30 × 60 cm etc., accelerating and facilitating laying in glue class C2. If necessary, the mesh of the set may be cut into individual bands or listellos. The size of the sets and joints may be corrected to suit adjacent elements and large tiles. Permitted deviations from the declared sizes are described in the Technical Construction Regulations – STO – see the website www.rako.eu.

FR Dimensions nominales et déclarées:

Les éléments de revêtement céramiques sont désignés selon EN 14411 par les **dimensions nominales** en cm, par ex. 10 × 10, 20 × 20 cm. La dimension concrète produite – **dimension déclarée (W)** de l'élément céramique est indiquée sur l'emballage en mm. La norme EN ISO 10545-2 décrit la méthodologie de détermination des paramètres géométriques des éléments de revêtement céramiques et des écarts admis par rapport aux dimensions déclarées. Les valeurs réclamées et tolérances pour tous les types de produits de la société LASSELSBERGER, s.r.o. sont indiquées dans les annexes informatives des catalogues RAKO OBJECT I HOME.

Eléments de revêtement rectifiés

Les carreaux de sol à faible degré d'absorption de dimensions 10 × 10, 20 × 20, 22,5 × 45, 22,5 × 22,5, 45 × 45, 15 × 60, 30 × 60, 60 × 60, 20 × 80, 40 × 80, 80 × 80, 20 × 120, 30 × 120, 60 × 120 et 120 × 120 cm et les carreaux muraux de 30 × 60, 30 × 90 et 40 × 120 cm sont principalement proposés avec des bords rectifiés qui sont travaillés avec une grande précision et qui permettent une pose avec un joint de seulement 2 mm. **Dans le catalogue, les éléments de revêtement rectifiés (rodés) sont toujours désignés par l'icône avec la lettre R.** Les bords rectifiés des carreaux muraux et de sol sont fragiles et nécessitent une manipulation soignée et attentive. Un mouvement imprudent et le contact avec un autre matériau peuvent entraîner le détachement du bord ou du coin du revêtement.

Eléments de revêtement non rectifiés

Les éléments de revêtement non rectifiés de la série ColorTWO et TAURUS du catalogue RAKO OBJECT sont principalement fabriqués dans des dimensions modulaires 8. En outre sont fabriqués des carreaux de revêtement non rectifiés de dimensions modulaires 8 dans le catalogue RAKO HOME au format 20 × 40, 20 × 60 et 30 × 60 cm et des carreaux non rectifiés de format 10 × 10, 20 × 20, 10 × 30, 10 × 20, 30 × 30, 45 × 45 et 30 × 60 cm. **Concernant les carreaux non rectifiés, y compris les formes spéciales, la dimension déclarée du produit – indiquée dans le lot – joue un rôle essentiel. Elle est importante lorsque vous souhaitez composer plusieurs types de revêtements céramiques sur une même surface, tout en conservant partout un joint de même largeur. Du fait des imprécisions dimensionnelles naturelles des produits non rectifiés, nous ne recommandons pas de faire des joints inférieurs à 2 mm. Les différences dimensionnelles conformes à la norme sont visibles dans le cas des joints très étroits. C'est pourquoi il est conseillé de faire des joints de 3 à 4 mm environ lors de la pose de carreaux non rectifiés.**

Dimensions modulaires

Les dimensions modulaires, par ex. M 10 × 10, M 20 × 20 cm, sont appropriées pour la combinaison d'éléments de revêtement de divers formats dans une surface tout en gardant des joints continus. Par ex. pour une dimension 8 (598 × 598, 298 × 598 mm), cela permet de combiner de manière modulaire les formats indiqués de carreaux rodés et standards, le cas échéant de carreaux de revêtement rectifiés sur une surface avec le même joint. **Les joints inférieurs à 2 mm réduisent la capacité d'absorption des tensions entre le support et les carreaux. La pose de carrelage sans joint est fortement déconseillée. Cette méthode empêche complètement l'absorption des contraintes entre le support et les carreaux. De plus, il est alors impossible d'éliminer les saletés accumulées dans les interstices.** Les produits céramiques avec dimensions modulaires sont formés par les multiples de la dimension de base. La largeur du joint unifié est également comptabilisée dans la dimension du produit, il est donc possible de créer un joint régulier également dans une surface de divers formats.

Mosaïques, décors

Ils sont proposés, par ex. dans les dimensions nominales 2,5 × 2,5, 5 × 5, 5 × 10 cm, etc. **Les dimensions de chaque type de mosaïque, décor et accessoire découlent des dimensions des formats de base, avec lesquelles leurs dimensions s'harmonisent.** Chaque élément est collé sur des trames en plastique ou papier – kits de dimensions 30 × 30, 30 × 60 cm, etc., accélérant et simplifiant la pose dans une matière collante de classe C2. En cas de besoin, il est possible en découpant la trame d'ajuster les kits en bandes, listels ou de corriger la taille des kits et des joints selon les éléments environnants et les carreaux à grande surface. Les Règlements techniques de construction – STO, voir pages www.rako.eu, décrivent les écarts admis par rapport aux dimensions déclarées.



Wasseraufnahme | Water absorption | Absorption d'eau

DE Wasseraufnahme

Die Werte der Wasseraufnahme gelten als wichtiges Kriterium bei der Auswahl keramischer Fliesenbeläge. Sie werden durch die Gewichtszunahme in Prozent nach vollständiger Wassersättigung ermittelt. Die Prüfung erfolgt entsprechend der Norm EN ISO 10545-3.

Klassifizierungen bei Feuchtigkeitsbeanspruchung

Die unterschiedlichen Einsatzbereiche und Beanspruchungen erfordern eine Einteilung in Beanspruchungsklassen.

Wassereinwirkungskategorie	Wassereinwirkung	Anwendungsbeispiele	Fliesengruppen	
W0-I	gering	Flächen mit gelegentlicher Einwirkung von Spritzwasser	• Bereiche von Wandflächen in Bädern außerhalb von Duschbereichen und häuslichen Küchen • Bereiche von Bodenflächen im häuslichen Bereich ohne Ablauf z.B. in Küchen, Hauswirtschaftsräumen, Gäste-WCs	BIII GL BIIa GL, UGL
W1-I	mäßig	Flächen mit häufiger Einwirkung von Spritzwasser oder gelegentlicher Einwirkung von Nutzwasser	• Wandflächen über Badewannen und in Duschen in Bädern • Bodenflächen im häuslichen Bereich mit Ablauf • Bodenflächen in Bädern ohne/mit Ablauf und ohne hohe Wassereinwirkung aus dem Duschbereich	BIII GL BIIa GL, UGL
W2-I	hoch	Flächen mit häufiger Einwirkung von Spritzwasser, Nutzwasser und auf dem Boden angestautem Wasser	• Wandflächen von Duschen in Sportstätten/Gewerbstätten • Bodenflächen mit Abläufen und/oder Rinnen • Bodenflächen in Räumen mit bodengleichen Duschen • Wand- und Bodenflächen von Sportstätten/Gewerbstätten	BIIa GL, UGL
W3-I	sehr hoch	Flächen mit sehr häufiger oder langanhaltender Einwirkung von Spritz- und/oder Nutzwasser, Wasser aus intensiven Reinigungsverfahren und angestautem Wasser	• Flächen im Bereich von Umgängen von Schwimmbecken • Duschen und Duschanlagen in Sportstätten/Gewerbstätten • Flächen in Gewerbestätten (gewerbliche Küchen, Wäschereien, Brauereien etc.)	BIIa GL, UGL

Der tatsächliche Verwendungszweck eines Produkts ist abhängig von der Nutzung und den technischen Eigenschaften. Bitte wenden Sie sich im Zweifelsfall an unsere Fachberater unter www.rako.eu.

EN

Water absorption is the most important property in selection of a tiling material for a specific environment. Water absorption is ability of a fired ceramic product to absorb liquid, and is a percentage expression of the ratio of water absorbed by a test specimen and the weight of the dry specimen under the conditions of test standard EN ISO 10545-3. Ceramic tiles with low water absorption show best operating characteristics and resistance to the most severe operating conditions, especially frost resistance.

FR

L'absorption d'eau, est le paramètre le plus important pour le choix du carrelage en fonction de son utilisation et de sa destination. L'absorption d'eau, est la possibilité d'un produit émaillé à absorber un liquide. Elle s'exprime par le pourcentage de poids de l'eau absorbée dans un échantillon d'essai par rapport au poids de cet échantillon séché, suivant les conditions de la norme d'essais EN ISO 10545-3. Les carreaux céramiques avec faible absorption d'eau ont les meilleures propriétés pour l'utilisation dans des conditions les plus difficiles, et particulièrement au gel.



Frostbeständigkeit | Frost resistance | Résistance au gel

DE

Im Außenbereich dürfen nur frostbeständige Fliesen eingesetzt werden. Die niedrige Wasseraufnahme des Feinsteinzeugs schafft dafür ausgezeichnete Voraussetzungen. Geprüft wird die Frostbeständigkeit nach EN ISO 10545-12, bei dem die keramischen Elemente einer definierten Anzahl von Frost- Tauwechseln ausgesetzt sind. Poröse Fliesen sind dagegen nicht frostbeständig und ausschließlich für Innenräume bestimmt. Für Boden und Wände im Außenraum empfehlen wir das hochbeständige unglasierte oder glasierte Feinsteinzeug der Klasse BIIa nach EN 14411.

EN

For exteriors it is necessary to use only frost resistant ceramic tiles, which resist long action of frost and weather. Frost resistance is tested by stated number of frosting and defrosting cycles under specified conditions according to standard EN ISO 10545-12. There is a relation between frost resistance and water absorption. The lower is water absorption the higher is frost resistance. Ceramic wall tiles EN 14411 BIII are not frost resistant and therefore are suitable for interiors only. For exterior floors and walls we recommend using highly resistant unglazed or glazed vitrified tiles, group BIIa according to EN 14411.

FR

Pour carrelages destinés à l'extérieur, utiliser uniquement des revêtement en grès qui résistent à l'influence de longue durée du gel et des intempéries. La résistance au gel est testée par un nombre donné des cycles gel/dégel sous des conditions prescrites dans la norme EN ISO 10545-12. Il y a une certaine relation entre la résistance au gel et l'absorption d'eau. Une absorption de l'eau inférieure est la condition préalable de la résistance au gel plus élevée. Tous les produits RAKO OBJECT sont résistant au gel sauf les carreaux de mur destinées uniquement aux intérieurs. Les Faïences murales EN 14411 BIII ne sont pas ingelives et donc préconisées que pour l'intérieur. Pour les sols et les murs extérieurs, nous recommandons les carreaux à hautes résistances non émaillés ou émaillés frittés du groupe BIIa, conformes à la norme EN 14411.

DE Die Abriebfestigkeit keramischer Fliesen wird in unterschiedliche Abriebgruppen PEI 1 bis PEI 5 entsprechend der Norm EN ISO 10545-7 eingeteilt. Die im Wohnbereich eingesetzten keramischen Bodenfliesen bieten im Vergleich zu Laminatfußböden eine weitaus höhere Widerstandsfähigkeit gegen Oberflächenverschleiß.

• **Gruppe PEI 1 - sehr leichte Beanspruchung**

Bodenbeläge in Räumen mit niedriger Belastung, und geringer kratzender Verschmutzung und die Benutzung mit weich besohltm Schuhwerk.
Beispiele: Private Wohnbereiche, außer Küchen, Loggien, Terrassen, Treppen

• **Gruppe PEI 2 - leichte Beanspruchung**

Bodenbeläge in Räumen mit niedriger Belastung, und geringer kratzender Verschmutzung und die Benutzung mit normalem Schuhwerk.
Beispiele: Private Wohnbereiche, außer Küchen, Loggien, Terrassen, Treppen

• **Gruppe PEI 3 - mittlere Beanspruchung**

Bodenbeläge in Räumen mit mittlerer Belastung und mittlerer Publikumsfrequenz, sowie kratzender Verschmutzung und die Benutzung mit normalem Schuhwerk.
Beispiele: Gesamter Wohnbereich, und auch in Hotelbädern.

• **Gruppe PEI 4 - stärkere Beanspruchung**

Bodenbeläge in Räumen mit starker Belastung und hoher Publikumsfrequenz, sowie kratzender Verschmutzung und die Benutzung mit normalem Schuhwerk.
Beispiele: Geschäftsräume, Küchen, Büros, Hotels, Schulen, Krankenhäuser.

• **Gruppe PEI 5 - starke Belastung**

Bodenbeläge in Räumen mit starker Belastung und sehr hoher Publikumsfrequenz, sowie kratzender Verschmutzung und die Benutzung mit normalem Schuhwerk.
Beispiele: stark frequentierte Geschäftsräume, Eingangsbereiche von Hotels, Schulen und Krankenhäuser.

EN Resistance to surface wear – abrasion resistance – is the ability of glazed ceramic products to resist certain abrasives under given conditions. Glazed floor tiles are divided into different resistance classes. The abrasion resistance of glazed floor tiles is determined according to EN ISO 10545-7 with aluminium-oxide-grains, balls of steel and water in an eccentric circling system in the PEI-wet-test. Artificial wear is simulated in an eccentrically circulating system, using particles of aluminium oxide, steel beads, and water. The tested tiles are then classified according to the speed during which the profile remains undamaged into categories PEI 1 to PEI 5. Ceramic tiles provide much higher abrasion resistance compared to laminate floorings.

• **Class PEI 1**

Glazed ceramic floor tiles for low interior foot traffic without the likelihood of scratching. Application in bathrooms, bedrooms, apartments except in entrance halls, terraces without the danger of dirt being brought in from outdoors.

• **Class PEI 2**

Glazed ceramic floor tiles for medium interior foot traffic. Application in bathrooms and apartments except in entrance halls and similar rooms with heavier traffic and a danger of dirt being brought in from outdoors.

• **Class PEI 3**

Glazed ceramic floor tiles for medium but heavier foot traffic with slight risk of abrasion, such as living rooms, hotel bathrooms.

• **Class PEI 4**

Glazed ceramic floor tiles for medium to high foot traffic with risk of abrasion and normal work shoes in entrance halls, commercial rooms and offices.

• **Class PEI 5**

Glazed ceramic floor tiles for use in high foot traffic areas such as doorways, stores, corridors, garages, railway stations and airport halls.

FR Pour les carrelages utilisés comme revêtements de sol, la résistance à l'abrasion superficielle particulièrement importante. Les classements de la résistance à l'abrasion des carrelages de grés émaillés sont déterminés selon la norme EN ISO 10545-7.

Le classement en groupe d'usure se fait sur la base d'un test normalisé appelé PEI. Les conditions d'utilisation sont reproduites à l'aide d'oxyde d'aluminium, de billes d'acier et d'eau dans un système simulant une abrasion artificielle générée par des mouvements circulaires excentriques. Les carrelages sont classés en fonction du nombre de rotations subies sans présenter d'usure, apparente en groupe allant de PEI 1 à PEI 5. Les dalles en céramique utilisées dans les logements offrent une plus grande résistance à l'usure de surface par rapport aux revêtements de sol stratifiés.

• **Groupe d'usure PEI 1:** Carrelages émaillés soumis à une fréquence de passage très faible sans présence d'agents abrasifs. Destination pour les salles de bain, les chambres à coucher, les appartements, hormis les entrées, les terrasses où il y a un danger de dépôt de salissures provenant de l'extérieur.

• **Groupe d'usure PEI 2:** Carrelages émaillés soumis à une fréquence de passage très faible avec des chaussures normales avec des apports d'agents abrasifs faibles. Destination pour les salles de bain et les appartements, hormis les locaux d'entrée et autres espaces similaires à fort trafic et où il y a un danger de dépôt de salissures provenant de l'extérieures.

• **Groupe d'usure PEI 3:** Carrelages émaillés soumis à un usage normal sans apport important d'agents abrasifs avec des chaussures normales. Utilisation dans l'ensemble de l'habitat, balcon.

• **Groupe d'usure PEI 4:** Carrelages émaillés pouvant être utilisés dans des locaux à fréquentation plus importante. Utilisation en entrées, commerces et bureaux.

• **Groupe d'usure PEI 5:** Carrelages émaillés pouvant être sollicités de manière intense et dans des locaux supposant une résistance forte tels que magasins, restaurants, et garage. Les dalles en céramique utilisées dans les logements offrent une plus grande résistance à l'usure de surface par rapport aux revêtements de sol stratifiés.



DE Die Beständigkeit gegen Tiefverschleiß (Abriebfestigkeit) kennzeichnet die Fähigkeit unglasierter gesinterter keramischer Produkte abrasiven Einflüssen standzuhalten. Das Prinzip der Prüfung, welche unter festgelegten Bedingungen nach der Norm EN ISO 10545-6 durchgeführt wird, ist die Ermittlung des Volumens der abgeriebenen Scherbenmasse, das beim Schleifen durch ein Prüfgerät an der Fliesenoberfläche entsteht. Für Räume, wo ein großer Tiefverschleiß der Bodenfliesen vorausgesetzt wird (Industrie, Lagerstätten, Nahrungsmittelbetriebe, Bahnhöfe, Unterführungen, Supermärkte) empfehlen wir, gesinterte unglasierte Feinsteinzeugfliesen der Marke RAKO zu verwenden.

EN Deep abrasion resistance (deep abrasive power) is ability of unglazed ceramic products to resist abrasion under specified conditions. Test principle is to determine the amount of material of the body on the tile face abraded away by grinding action of a test tool under specified conditions - according to standard EN ISO 10545-6. For with heavy loaded tiles (industry, warehouses, food-processing plants, railway stations, passageways, and supermarkets), the RAKO brand vitrified unglazed tiles are recommended.

FR La résistance à l'abrasion profonde est la caractéristique des produits de grés cérame frittés non émaillés de résister à l'abrasion sous des conditions données particulières. L'essai est basé sur la détermination de volume de la masse du tesson perdue par l'abrasion sur la surface du carreau, faite par la machine d'essais sous les conditions prescrites. L'essai de résistance à l'abrasion profonde est effectué suivant la norme EN ISO 10545-6. Dans les endroits où des sollicitations très fortes sont prévues (industrie, entrepôts, fabrication alimentaire, gares, passages souterrains, supermarchés), nous recommandons d'utiliser les carreaux de grés cérame frittés non émaillés de la marque RAKO.



DE Chemische Beständigkeit gemäß EN ISO 10545-13

Die chemische Beständigkeit wird nach EN ISO 10545-13 beurteilt. Keramische Belagselemente werden unterschiedlichen Prüflösungen ausgesetzt, nach einer vorgegebenen Wirkungszeit wird das Ergebnis visuell festgestellt und nach den unten genannten Klassen eingestuft. Die Belagselemente von LASSELSBERGER, s.r.o. widerstehen allen im Haushalt verwendeten Chemikalien sowie jenen die in Schwimmbecken eingesetzt werden (entsprechend EN ISO 10545-13). **Ausgewählte Fliesen mit erhöhter Chemiebeständigkeit eingestuft sind in die Klasse A. Sie widerstehen der Wirkung von Säuren und Laugen nach EN ISO 10545-13. Alle anderen Fliesen der LASSELSBERGER, s.r.o. sind mindestens mit der Klasse B eingestuft.**

Wässrige Prüflösungen

- Im Haushalt verwendete Chemikalien: Ammoniumchloridlösung 100 g/l;
- Salze zur Wasserbehandlung im Swimmingpool: Natriumhypochloridlösung 20 g/l

Säure- und Alkalibeständigkeitsklassen nach EN ISO 10545-13 (Hersteller deklariert nur erreichte Klasse):

- A/B/C*

Säuren und Laugen:

- Geringe Konzentration (L)
 - a) Salzsäurelösung 3 %
 - b) Zitronensäurelösung 100 g/l
 - c) Kaliumhydroxidlösung 30 g/l
- Hohe Konzentration (H)
 - a) Salzsäurelösung 18 %
 - b) Milchsäurelösung 5 %
 - c) Kaliumhydroxidlösung 100 g/l

Chemische Beständigkeitsklassen für den Haushalt gemäß EN ISO 10545-13 (mindestens Klasse B erforderlich):

- A/B/C*

* Klasse A höchste Beständigkeit nach C abnehmend.

Fleckbeständigkeit gemäß EN ISO 10545-14

Die Oberfläche der Fliesen wird fleckbildenden Prüflösungen für einen in der Norm definierten Zeitraum ausgesetzt. Nach einem ebenfalls normativ festgelegten Reinigungsvorgang wird eine mögliche optische Veränderung visuell festgestellt, und die Fliesen werden einer der 5 Fleckbeständigkeitsklassen zugeordnet.

Fleckenbildende, zur Prüfung verwendete Stoffe

- Spurenbildende Fleckenbildner; grüne Fleckenbildner in Öl; rote Fleckenbildner in Öl; chemische Fleckenbildner; Jod, 13 g/l in Alkohol;
- Filmbildende Fleckenbildner, Olivenöl

Reinigung

- Reinigungsmittel: Heißes Wasser (+55 °C), schwaches Reinigungsmittel (pH 6,5-7,5), starkes Reinigungsmittel (pH 9-10)
- Lösungsmittel: Salzsäurelösung 3 %; Kaliumhydroxid-Lösung 200 g/l, Aceton
- Ungeeignete Chemikalien: Flusssäure, die die keramischen Bodenfliesen irreversibel beschädigt.

Klassen: 5/4/3/2/1*

* Klasse 5 weist die höchste Fleckbeständigkeit auf, nach Klasse 1 abnehmend.

Blei- und Cadmiumabgabe gemäß EN ISO 10545-15

Die Menge vom losen Blei und Cadmium wird auf Grund der laugenausgewaschenen Oberfläche keramischer Belagselemente mit einer Essiglösung ermittelt.

EN Resistance to chemicals, EN ISO 10545-13

Chemical resistance is assessed according to EN ISO 10545-13. Ceramic tiles are exposed to test solutions and, depending on inspection results after a set period, they are divided into the following classes. LASSELSBERGER, s.r.o. tiles are resistant to household chemicals and agents for water treatment in swimming pools according to EN ISO 10545-13. **Selected tiles with increased chemical resistance, classified in Class A, are resistant to acids and alkali according to EN ISO 10545-13. Other LASSELSBERGER, s.r.o. tiles are classified as follows: min. B, see www.rako.eu.**



Chemische Eigenschaften | Chemical Properties | Propriétés chimiques

Aqueous test solutions

- Household chemicals: ammonium chloride solution 100 g/l
- Salts for water treatment in swimming pools: sodium hypochlorite solution 20 mg/l

Acid and alkali resistance classes according to EN ISO 10545-13 (manufacturer only declares achieved class):

- A/B/C*

Acids and alkalis:

- Low concentration (L)
 - a) hydrochloric acid solution 3%
 - b) citric acid solution 100 g/l
 - c) potassium hydroxide solution 30 g/l
- High concentration (H)
 - a) hydrochloric acid solution 18%
 - b) lactic acid solution 5%
 - c) potassium hydroxide solution 100 g/l

Household chemical resistance classes according to EN ISO 10545-13 (minimum of class B required):

- A/B/C*

* Class A shows the highest resistance to chemicals, which decreases more and more towards C.

Stain resistance, EN ISO 10545-14

Tile surfaces are exposed to test solutions of stain-forming substances for a set period, cleaned in the specified manner, and changes are visually assessed. Following the results, the tiles are classified into five classes.

Stain-forming substances used for testing:

- Green stain forming substances in oil; red stain forming substances in oil; iodine, 13 g/l in alcohol; olive oil

Cleaning

- Cleaning agent: hot water (+55 °C); weak cleaning agent (pH 6.5-7.5); strong cleaning agent agent (pH 9-10)
- Solvent: hydrochloric acid solution 3%; potassium hydroxide solution 200 g/l; acetone
- Unsuitable chemical substances: ceramic tiles are not hydrofluoric acid resistant

Classes: 5/4/3/2/1*:

* Class 5 shows the highest stain resistance, which decreases more and more towards 1.

Lead and cadmium delivery, EN ISO 10545-15

The quantity of released lead and cadmium is determined on the basis of extraction of glazed tile faces with the acetic acid solution.

FR Résistance chimique selon norme EN ISO 10545-13

Leur résistance chimique est évaluée selon EN ISO 10545-13. Les revêtements en céramique sont exposés à l'effet de solutions d'essai et, selon l'effet constaté visuellement après un certain temps d'action, ils sont subdivisés en les classes suivantes. Les revêtements LASSELSBERGER, s.r.o. résistent aux agents chimiques ménagers et aux produits pour le traitement de l'eau dans les piscines selon la norme EN ISO 10545-13. **Les revêtements sélectionnés avec une résistance accrue aux produits chimiques, classés dans la catégorie A, résistent à l'action des acides et des alcalis selon la norme EN ISO 10545-13, d'autres revêtements LASSELSBERGER, s.r.o. sont classés comme suit: min. B, voir pages www.rako.eu.**

Solutions aqueuses

- Produits chimiques ménagers: Chlorure d'ammonium à raison de 100g par litre;
- Sels de traitement de l'eau dans les piscines: hypochlorite de sodium à raison de 20g par litre

Classes de résistance aux acides et aux alcalis selon la norme EN ISO 10545-13 (le fabricant ne déclare que la classe atteinte):

- A/B/C*

Bases et acides:

- Concentration faible (L)
 - a) acide chlorhydrique 3%
 - b) acide citrique 100 g/litre
 - c) Hydroxyde de potassium 30 g/litre
- Concentration élevée (H)
 - a) acide chlorhydrique 18%
 - b) acide lactique: 5%
 - c) Hydroxyde de potassium 100 g/litre

Classes de résistance aux produits chimiques ménagers selon la norme EN ISO 10545-13 (classe B minimum requise):

- A/B/C*

* Classement de A résistance élevée à C résistance faible.

Résistance aux taches selon norme EN ISO 10545-14

L'envers des carreaux est exposé à des essais aux solutions d'agents causant des taches pour une certaine période, ensuite, les surfaces des envers sont nettoyées de la manière indiquée et les changements sont évalués visuellement. Suite aux résultats, les carreaux sont classés en cinq catégories.

Agents causant des taches utilisés pour l'essai:

- vertes pour l'huile, rouges pour l'huile, lode en dilution de 13 g/l dans de l'alcool, huile d'olive

Nettoyage

- produits d'entretien: eau chaude (+ de 55°), produit d'entretien faible (pH 6,5-7,5) ou puissant (pH 9-10)
- Excipient : acide chlorhydrique 3%, solution de potasse caustique 200 g/l, acetone
- Produits chimiques inappropriés : acide fluorhydrique, qui endommage de manière irréversible le matériau des dalles en céramique.

Classement: 5/4/3/2/1*

* Le classement en groupe 5 offre la résistance la plus élevée, le groupe 1 la plus faible.

Emission de plomb et de cadmium selon norme EN ISO 10545-15

La quantité du plomb et du cadmium libérés est déterminée sur la base du lessivage de l'envers de la surface glaçurée des revêtements en céramique avec de la solution de vinaigre.



Bruchfestigkeit | Breaking resistance | Résistance à la rupture

DE Die mechanische Bruchfestigkeit von Keramikfliesen wird durch mehrere Messmethoden bestimmt: Biegefestigkeit, Bruchlast und Bemessungstragfähigkeit.

Die **Biegefestigkeit** nach EN ISO 10545-4 drückt die Fähigkeit aus, mechanischen Belastungen, zerstörungsfrei standzuhalten. Je kleiner die Fläche und je größer die Stärke der Fliese ist, desto höher ist die Belastbarkeit. Produkte in der Stärke 8–10mm sind für den allgemeinen Gebrauch in Wohnräumen oder für Bereiche die mit Luft gefüllten Rädern befahren werden (z.B. Ausstellungsräumen in Autohäusern) geeignet. Bodenbeläge mit höheren mechanischen Beanspruchungen, die beispielsweise mit Vulkanollan- oder Polyamidrädern befahren werden, müssen mind. nach den Vorgaben der Belastungsgruppe 3 ausgeführt werden. Für Bereiche der Belastungsgruppe 3 sind zwingend Produkte der Serien Taurus INDUSTRIAL in Überstarker Ausführung in 14mm oder Kaamos INDUSTRIAL in 15mm zu verwenden. Keramische Produkte sind für Böden, die mit Stahlrädern ohne Gummibeschichtung befahren werden, nicht geeignet- siehe Bild 2 und Tabelle 1. Bei der Bemessung der Belastungsgruppe ist neben der stationären Gewichtsbelastung, das ggf. verwendete Rollenmaterial und die damit verbundene instationäre Belastungen zu berücksichtigen.

Die **Bruchkraft (F)** ist die zum Brechen des Prüflings erforderliche Kraft. Die nach EN ISO 10545-4 ermittelt wird. **Bruchlast (S)** ist eine Kraft, die nicht vom Format der Fliese (Breite und Länge) abhängt, sondern nur von ihrer Stärke (h). Wir bewerten es für Fliesen, die nicht fest mit dem Untergrund verbunden sind (nach EN ISO 10545-4). Der Schwellenwert für den Bruch wird durch die Bruchfestigkeit ausgedrückt- siehe Tabelle 2. Produkte zur Trockenverlegung oder auf Stelzlager müssen für eine sichere Konstruktion danach bemessen werden. Gemäß ČSN EN 1991-1-1 „Belastungen von Bauwerken“ und ČSN 73 2030 müssen Belastungsprüfungen unter Berücksichtigung einer ausreichenden Reserve durchgeführt werden.

Die Bemessungstragfähigkeit basiert auf Labormessungen der Tragfähigkeit von an mehreren Stellen belasteten Fliesen. Für Fliesen im Format 60 × 60 cm, Dicke 2 cm sind maximal 5 000 N (± 500 kg) gewährleistet siehe Tabelle 2. Die Verlegung auf Stelzlager ist nur für den Fußgängerverkehr geeignet ein Befahren mit Fahrzeugen ist nicht zulässig.

Berechnung der Biegefestigkeit (N/mm², MPa) nach der EN ISO 10545-4

$$R = \frac{3 \times F \times L}{2 \times b \times h^2}$$

Bruchlast (N) nach der EN ISO 10545-4

$$S = \frac{F \times L}{b}$$

F = Bruchkraft in N, L = Stützweite in mm, b = Breite in mm, h = Dicke in mm, R = Biegefestigkeit in N/mm²

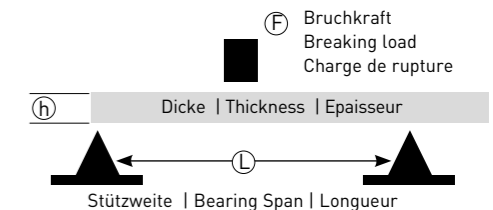

EN Mechanical resistance of ceramic tiles to breakage is determined by several methods of measurement: modulus of rupture, breaking strength and design load capacity

Modulus of rupture according EN ISO 10545-4 expresses the tile ability to resist without destruction a mechanical load. The tiles of smaller sizes and larger thickness are more resistant than thinner tiles of larger sizes. Products with a thickness of 8–10 mm are suitable for general use in residential areas or where tyres are filled with air (e.g. car showrooms, garages). Floors subjected to higher mechanical stresses (shops, warehouses, industry), e.g. with Vulkollan or polyamide wheels, are then classified in load group 3–5, see Table 1, Working procedures for high-load pavements. Taurus INDUSTRIAL in 14 mm thickness or Kaamos INDUSTRIAL in 15 mm thickness are recommend here. Ceramic products are not suitable for floors that are traversed with steel wheels without rubber, see Table 4, Mean loads under different transport vehicle wheels. In addition to the stationary load, the wheel material used and the dynamic surface load must also be taken into account.

Breaking load is force necessary to cause the test specimen to break, as read to pressure gauge (EN ISO 10545-4). Threshold value to fracture the tile is expressed by breaking strength – see Table 2.

Tiles to be layed by dry method (on support system) have to be selected with respect to following threshold values to secure safe construction according to ČSN EN 1991-1-1 Construction loading and ČSN 73 2030 Loading tests of building constructions. **Design load capacity** is based on laboratory measurement of bearing capacity of tiles loaded on several spots. For the size of tile 60 × 60 cm in thickness of 2 cm bearing (loading) capacity is max. 5 000 N (± 500 kg). For laying into gravel the values of design load capacity for the size 60 × 60 cm in thickness of 2 cm as safe values can be considered.

Modulus of rupture (N/mm², MPa) according to EN ISO 10545-4

$$R = \frac{3 \times F \times L}{2 \times b \times h^2}$$

Breaking strength (N) according to EN ISO 10545-4

$$S = \frac{F \times L}{b}$$

F = breaking load in N, L = distance between edges in mm, b = width in mm, h = thickness in mm, R = modulus of rupture N/mm²

FR Résistance à la flexion exprime la capacité des carreaux de sol résister, sans leur destruction, aux sollicitations mécaniques causées p. ex. par des chariots élévateurs. Les carreaux d'un format moins grand et plus épais ont la résistance plus grande que les carreaux plus grands et moins épais. Pour utilisation ordinaire sur les surfaces résidentielles, social, bureau etc. Les produits d'une épaisseur de 8 à 10 mm conviennent pour une utilisation générale dans les espaces habitables ou bien dans les lieux de circulation de véhicules à pneus gonflables (par ex. concessions automobiles, garages). Les sols exposés à une sollicitation mécanique supérieure (magasins, entrepôts, espaces industriels), par exemple du fait du passage de roues en caoutchouc vulcanisé ou en polyamide, sont ensuite classés dans des catégories de sollicitation 3 à 5, voir le tableau 5, Modes opératoires pour carreaux soumis à des charges importantes. Nous recommandons alors d'utiliser des produits de la gamme Taurus INDUSTRIAL d'une épaisseur de 14 mm ou bien Kaamos INDUSTRIAL d'une épaisseur de 15 mm. Les carreaux en céramique ne sont pas du tout adaptés à la circulation de roues métalliques sans protection caoutchoutée, voir tableau 4 Sollicitation moyenne pour différentes roues de véhicules. En plus de la sollicitation stationnaire, il est encore important de prendre en compte le matériau des roues utilisées et la sollicitation dynamique du carrelage.



Bruchfestigkeit | Breaking resistance | Résistance à la rupture

Charge de rupture est la force nécessaire pour rompre le corps d'essai telle qu'elle est lue sur le dispositif de mesure pendant l'essai selon EN ISO 10545-4. La valeur limite de rupture de la dalle est au contraire exprimée par la **force de rupture** - voir le Tab. 2.

Nous ne choisissons cependant jamais les dalles pour la pose dédiée en fonction de la valeur limite de rupture. Conformément à la norme ČSN EN 1991-1-1 relative aux charges structurelles et à la norme ČSN 73 2030 relative aux essais de charges structurelles des constructions, nous devons proposer des dalles dotées d'une marge de sécurité. Cette marge est comprise dans la **capacité de charge proposée**, des tests de charge des dalles étant réalisés en divers endroits en laboratoire. La capacité de charge nominale des dalles en format 60 × 60 d'épaisseur 2 cm est d'au max. 5 000 N (± 500 kg). Pour une pose sur du gravier, les valeurs des forces de rupture mesurées, pour le format 60 × 60 en épaisseur 2 cm, peuvent être considérées comme sûres.

Calcul de résistance à la flexion (N/mm², MPa) selon EN ISO 10545-4

$$R = \frac{3 \times F \times L}{2 \times b \times h^2}$$

Force de rupture (N)

$$S = \frac{F \times L}{b}$$

F = charge de rupture N, **L** = distance des arêtes en mm, **b** = largeur en mm, **h** = épaisseur en mm, **R** = résistance en N/mm²

Bild 2 | Fig. 2

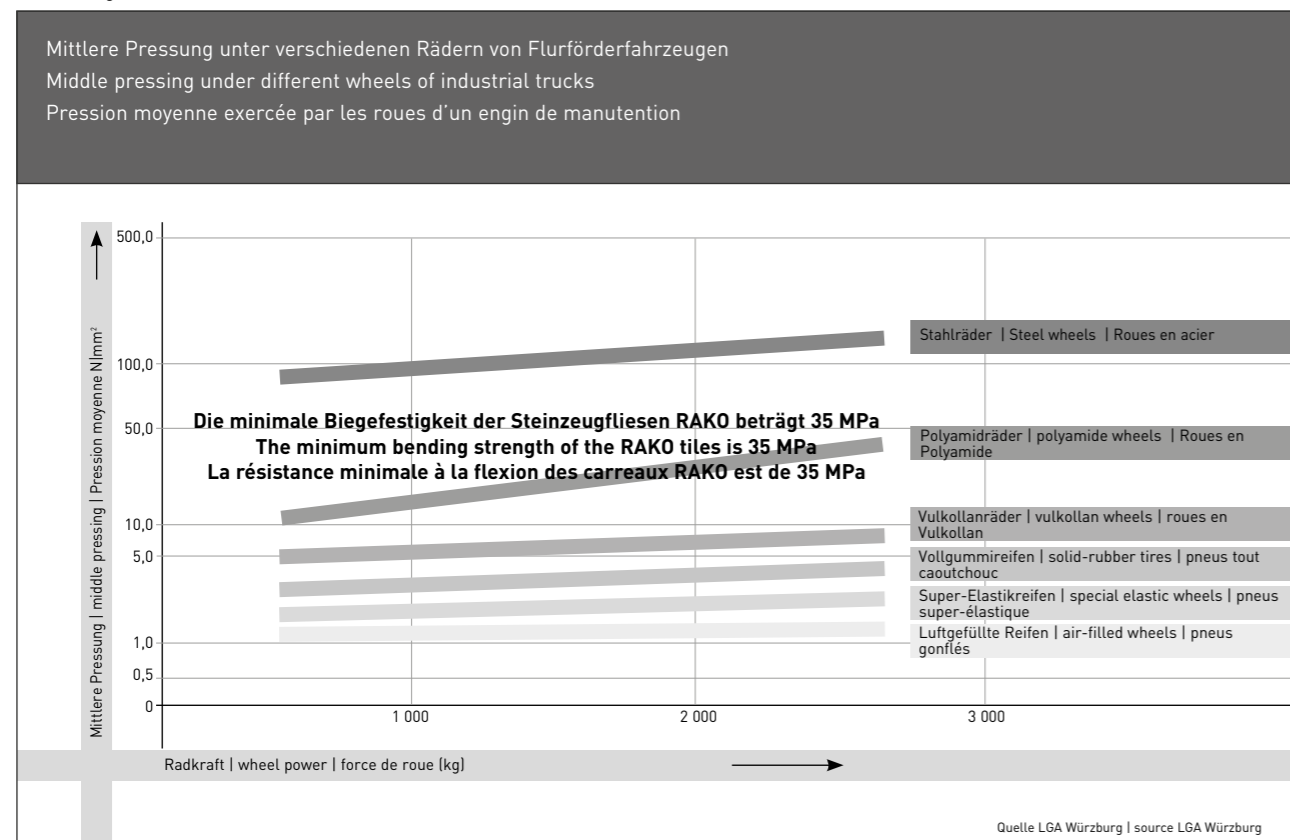

Tab. 1

Arbeitsvorgänge für ZDB Standard schwerbelastbare Fliesenbeläge Work procedures for tiles with a high amount of traffic (recommending guideline according to German ZDB Standard) Procédures de travail pour les carreaux à grande charge (ligne directrice de recommandation selon la ZDB Standard)		
Belastbarkeitsgruppe Traffic load group Groupe de charge	Belastbarkeitsgruppe Traffic load group Groupe de charge	Bruchlast beim Bruch der Fliese (N) Breaking strength after breaking the tile (N) Force de rupture lors de l'altération du carreau (N)
1	Wohnungen, Bäder flats, bathrooms appartements, salles de bains	< 1 500
2	Geschäfte, Büros, Ausstellungen shops, offices, exhibitions magasins, bureaux, expositions	1 500-3 000
3	Geschäfte, Industrie, Lager shops, industry, warehouses magasins, industrie, entrepôts	3 000-5 000
4	Industrie (befahrbar mit Wagen mit Vulkollan- oder Polyamidrädern) industry (motion of trucks with volcano or polyamide industrie (passage de chariots avec Vulkollan ou polyamide)	5 000-8 000
5	Industrie (Rollen der Wagen mit Polyamid- oder Metallrädern) industrie (motion of trucks with polyamide or metal wheels) industrie (passage de chariots avec polyamide ou roues en métal)	> 8 000

Tab. 2

Produktgruppe mit Katalognummern Group of products with catalogue numbers Référence des produits indiqués dans le catalogue	Dicke Thickness Epaisseur [mm]	Bruchlast Breaking strength Force de rupture [N] EN ISO 10545-4	Bemessungstragfähigkeit Design load capacity Capacité de charge proposée [N] (±kg) ČSN EN 1991-1-1 ČSN 732030
Dxxxxxxx, Gxxxxxxx, Txxxxxxx	< 7,5	700	
Gxxxxxxx, Dxxxxxxx	≥ 7,5	1 300	
Txxxxxxx a Dxxxxxxx (quadratisches Format square format format carré) außer Großformate except big formats sauf pour les grands formatst) *	≥ 8	1 500	
Dxx92xxx (quadratisches Format square format format carré) 120 × 120 cm	≥ 8,5	1500	
Txx3Vxxx, Txx2Zxxx	≥ 14	5 000	
TxxSExxx, DxxSExxx, Txx63xxx, a Dxx63xxx	≥ 10	2 000	
Dxx65xxx	≥ 15	6 000	
Dxx66xxx	≥ 20	11 000	5 000 (± 500)
DxxV6xxx (Format 60 × 120 cm OUTDOOR)	≥ 20	11 000	5 000 (± 500) bei Verwendung von 6 Stelzlagern auf 1 Fliese
TxxSRxxx, DxxSRxxx, Txx62xxx, Dxx62xxx, DxxV9xxx	≥ 9	1 500	

*Große Formate von Keramikfliesen mit einer Länge von einer Größe ≥ 80 cm. | Big formats of ceramic tiles with length of one size ≥ 80 cm. | Grands formats de carreaux à partir de la longueur d'un des côtés ≥ 80 cm

DE Die Produkte von LASSELSBERGER, s.r.o. werden regelmäßig auf strahlenhygienische Unbedenklichkeit geprüft, und zwar in Übereinstimmung mit der Ausführungsverordnung des Staatsamtes für Kernsicherheit Nr. 422/2016 GBl. in der aktuellen Fassung des Gesetzes Nr. 263/2016 GBl. Die Erzeugnisse der Firma LASSELSBERGER, s.r.o. erfüllen die oben aufgeführten Anforderungen und sind **unbedenklich**. Keramische Elemente von LASSELSBERGER, s.r.o. werden regelmäßig auf die Auslaugung von Blei (Pb) und Kadmium (Cd) aus Glasuren nach EN ISO 10545-15 geprüft. Die durchgeführten Analysen bestätigen die gesundheitliche Unbedenklichkeit keramischer Belagselemente von LASSELSBERGER, s.r.o., siehe Leistungserklärung unter www.rako.eu.

Keramische Wand- und Bodenbeläge einschließlich keramischer Formstücke der Serien Betonico, Color TWO und TAURUS erfüllen die strengen hygienischen Anforderungen in lebensmittelverarbeitenden Bereichen und medizinischen Einrichtungen. Hohlkehlsocle die Formteile können stehend und liegend eingebaut werden und erleichtern die Reinigung im Wandanschlussbereich. Je nach Ländervorschrift sind diese teilweise obligatorisch.

EN LASSELSBERGER, s.r.o. products are regularly tested for radiation-hygienic safety as per the legal Decree by the State Office for Nuclear Safety 422/20016 Coll., as amended by Act 263/2016 Coll. LASSELSBERGER, s.r.o. products meet the requirements mentioned above, and they are **safe**. Ceramic products LASSELSBERGER, s.r.o. are regularly tested for release of lead (Pb) and cadmium (Cd) from glazes according to EN ISO 10545-15. The performed analyses prove the ceramic tiles by LASSELSBERGER, s.r.o., are harmless for human health, see the declaration of performance on www.rako.eu.

Selected TAURUS, ColorTWO and POOL products have attests of sanitary harmless in contact with food and drinking water on www.rako.eu, prepared by an independent sanitary laboratory.

Ceramic wall and floor tiles including shaped pieces, rounded mouldings with corrugation ColorTWO or TAURUS and Taurus GRANIT base moulding for food processing areas with radius R44 of the rounding are easy to maintain, thus allowing for compliance with the strict hygienic requirements for food processing plants and healthcare facilities. They are suitable for all types of applications requiring surfaces free of pathogenic germs, moulds, dust, and other pollutants.

Suitable application of ceramic tiles on floors and walls can also improve the home microclimate, e.g. reduce occurrence of dust, pollen and mites.

FR Les produits LASSELSBERGER s.r.o. sont régulièrement testés concernant l'innocuité pour les radiations et hygiénique conformément au décret exécutif de l'Office national de la sécurité nucléaire n° 422/2016 du J.O., dans la version actuelle de la loi n° 263/2016 du J.O. Les produits LASSELSBERGER s.r.o. répondent aux exigences susmentionnées et sont **sans danger**.

Les éléments céramiques LASSELSBERGER, s.r.o. sont régulièrement testés pour la libération du plomb (Pb) et du cadmium (Cd) des émaux selon EN ISO 10545-15. Les analyses réalisées confirment l'innocuité sanitaire des éléments de revêtement céramiques LASSELSBERGER, s.r.o., voir déclaration de propriétés sur www.rako.eu.

Pour certains produits TAURUS, ColorTWO et POOL sont disponibles sur www.rako.eu certificats les attestations d'innocuité hygiénique en contact avec des denrées alimentaires et de l'eau potable, déterminée par un atelier d'essais hygiéniques indépendant.

Les revêtements céramiques des murs et des sols, y compris les briques céramiques, socles arrondis avec auge ColorTWO ou TAURUS et le socle pour l'industrie alimentaire Taurus GRANIT ayant un rayon R 44, s'entretiennent facilement et permettent ainsi de remplir les strictes demandes hygiéniques dans les établissements alimentaires et médicaux. Ils sont adaptés partout où il est nécessaire de sécuriser des surfaces sans bactéries pathogènes, moisissures, poussière et impuretés.

Dans les appartements, il est également possible par une bonne application des éléments de revêtement céramiques sur les sols et les murs d'améliorer le microclimat, par ex. de diminuer la présence de poussière, de pollen et d'acariens.

DE Alle Fliesen der LASSELSBERGER, s.r.o. stellen auf Grund ihrer günstigen Wärmeleitfähigkeit und Wärmespeicherung einen idealen Bodenbelag in Verbindung mit Bodenheizungssystemen dar. Vergleich der Wärmeleitfähigkeit von Bodenbelägen:

Material	Wärmeleitfähigkeit λ (W/m·K)	Thermal emissionen b (λ·ρ·c)
Keramik	1.0	1.8
Zementhaute- strich / Beton	1.3	2.6
Anhydrit	1.8	3.8
PVC, Vinyl	0.2	0.3
Spanholzplatte	0.1	0.3

ρ – Volumgewicht (kg/m³)

c – spezifische Wärmekapazität (J/kg·K)

EN Thanks to their convenient thermal properties (conductivity and heat accumulation), all types of LASSELSBERGER, s.r.o. tiles are ideal floor coverings on underfloor heating.

Comparison of thermal conductivity of floor coverings:

Material	Coefficient of heat conductivity λ (W/m·K)	Thermal emission b (λ·ρ·c)
Ceramics	1.0	1.8
Cement screed / concrete	1.3	2.6
Anhydrite	1.8	3.8
PVC, vinyl	0.2	0.3
OSB boards	0.1	0.3

ρ – volume weight (kg/m³)

c – specific thermal capacity (J/kg·K)

FR Tous les types de carreaux LASSELSBERGER, s.r.o. sont une couverture de sol idéale pour le chauffage au sol du fait de leurs propriétés thermiques avantageuses (conductivité et accumulation de la chaleur). Comparaison de la conductivité thermique des couvertures de sol :

Matériau	Coefficient de con- ductivité thermique λ (W/m·K)	Émissions thermiques b (λ·ρ·c)
céramique	1.0	1.8
chape de ciment / béton	1.3	2.6
anhydrite	1.8	3.8
PVC, vinyle	0.2	0.3
Panneaux OSB	0.1	0.3

ρ – densité (kg/m³)

c – capacité thermique spécifique (J/kg·K)

Der Wärmeausdehnungskoeffizient von Steinzeug und Steingutfliesen ist sehr niedrig. Auf einer Länge von 6 m und einem Temperaturunterschied von 50 °C dehnt sich keramisches Material um 2,4 mm. Beton ändert unter den gleichen Bedingungen seine Länge etwa um das Doppelte (4,8 mm). Deshalb müssen Dehnungsfugen vorgesehen werden, die diese Verformungen und die daraus entstehenden Spannung im Untergrund ausgleichen können. Vergleich des Wärmeausdehnungskoeffizienten verschiedener Materialien:

Material	Temperaturkoeffizient der Wärmeausdehnung α (10 ⁻⁶ ·K ⁻¹)
Keramik	4–8
Zementhaute- strich / Beton	10–12
Stahl	12–13
Aluminium	22–28
PVC, Vinyl	50–66

The coefficient of thermal expansion of wall tiles and floor tiles is very low. At a distance of 6 m, and at a temperature difference of 50° C, the ceramic material is expanded by 2.4 mm. However concrete, for example, changes its length to about twice this value. Therefore, dilatation joints are performed, which are able to absorb such stresses in the base. Comparison of coefficients of linear thermal expansion for different materials:

Material	Coefficient of linear thermal expansion α (10 ⁻⁶ ·K ⁻¹)
Ceramics	4–8
Cement screed / concrete	10–12
Steel	12–13
Aluminium	22–28
PVC, vinyl	50–66

Le coefficient de dilatation thermique des dalles et des carreaux est très faible. À une distance de 6 m et à une différence de température de 50 °C, le matériau céramique se dilate de 2,4 mm. Par exemple, la dimension du béton change environ deux fois plus. Par conséquent, nous réalisons des joints de dilatation capables d'absorber de telles contraintes dans le substrat. Comparaison du coefficient thermique de la dilatation longitudinale de différents matériaux:

Matériau	Coefficient of linear thermal expansion α (10 ⁻⁶ ·K ⁻¹)
céramique	4–8
chape de ciment / béton	10–12
acier	12–13
aluminium	22–28
PVC, vinyle	50–66

DE Für die Fußböden von Operationssälen, Labors sowie Produktionsstätten für Arzneimittel, Explosionsstoffe und Mikroelektronik werden anti-statische Fußböden vorgeschrieben. Keramische Bodenfliesen sind elektrische Isolatoren, deshalb erfolgt die Ableitung der elektrischen Ladung durch elektrisch leitende Fugen.

EN Antistatic flooring is required for floors of operating theatres, laboratories, production of medical and pharmaceutical products, explosive substances and microelectronics. Ceramic tiles belong among electrical insulators, therefore, electric charge is discharged using conductive joints between small or mosaic tiles.

FR Pour les sols des salles d'opération, des laboratoires, d'un hall de production de médicaments, de substances explosives et de micro-électronique sont prescrits des sols antistatiques. Les carreaux céramiques sont des isolants électriques, par conséquent la conduite de la charge électrique s'effectue par des joints conducteurs entre des petits carreaux ou des carreaux en mosaïque.



Rutschhemmende Eigenschaften | Slipperiness | Glissance

DE Die Bewertung der rutschhemmenden Eigenschaften dienen der sicheren Begehung von Bodenbelägen unter Berücksichtigung bestimmter Nutzungssituationen. In Deutschland sind die Anforderungen durch die Bundesanstalt für Arbeitsschutz und Arbeitsmedizin, in der Arbeitsstättenregelung für mit Schuhen begangene Bereiche - ASR A1.5: Fußböden, festgelegt. Die Anwendung der Regelung ist für ganz Europa empfohlen. Die Ermittlung der Rutschhemmung von Bodenbelägen wird durch nachfolgende Normen und Methoden festgelegt und ermittelt.

- **EN 16165:2022** Ermittlung der Rutschfestigkeit (Determination of slip resistance of pedestrian surfaces-Methods of evaluation)
- **DIN 51 097** Ermittlung der Rutschfestigkeit für nasse Oberflächen im Barfuß Bereich
- **DIN 51 130** Ermittlung der Rutschfestigkeit für Arbeitsräume und Arbeitsflächen mit erhöhter Rutschgefahr
- **ASR A1.5: 2022** Arbeitsstättenregelung für mit Schuhen begangene Bereiche
- **DGUV 207-006** Bodenbeläge für nassgelastete Barfußbereiche
- **ANSI A137.1** Ermittlung der Rutschfestigkeit nach der in Nordamerika gültigen Norm

Die Tabellen zeigen die Rutschhemmungswerte der Fliesen RAKO HOME und RAKO OBJECT.

Mit ABS gekennzeichnete Produkte (ABS) stellen eine neue Generation der Oberflächen mit feiner, matter Mikrostruktur dar, wodurch sie eine höhere Rutschfestigkeit von R10/B erreichen. Selbstverständlich erfordern Oberflächen mit höherer Rutschhemmung stets eine erhöhte Sorgfalt bei der Pflege, einschließlich der Verwendung professioneller Reinigungsmittel.

In den Sortiment RAKO HOME und RAKO OBJECT sind die Produkte mit ABS-Oberfläche gekennzeichnet mit (ABS).

EN This is one of the most important surface properties of ceramic floor tiles, which determines the suitability of selected floor tiles for a particular room, and which guarantees safe movement of people. Requirements on the anti-slip properties of floors are specified by national regulations, for example in the Czech Republic by Public Notice No. 146/2024 and ČSN 74 4505 and ČSN 72 5191 standards, which should be complemented by safety regulations ASR A1.5: 2022, which can be recommended for buildings throughout Europe (see Table 1).

In Germany, these requirements are set out in Technische Regel für Arbeitsstätten – ASR 1.5:2022: Fußböden

Slip resistance of the ceramic tiles is determined by the method stated by the following standards:

- **EN 16165:2022** Determining slip resistance of pedestrian surfaces – Methods of evaluation, Determining slip resistance
- **DIN 51 097** Determination of sliding properties for wet surfaces for bare foot
- **DIN 51 130** Determination of sliding properties for working areas and surfaces with increased risk of slip
- **ASR A1.5: 2022** Safety regulations
- **ANSI A137.1** Determining slip resistance according to the standard valid in North America

According to ČSN 72 5191 and Regulation ASR 1.5:2022 (DIN 51 130) anti-slip floor tiles according to their slip angle for work floors should be used.

The following charts contain a summary of the tested anti-slip values of RAKO HOME and RAKO OBJECT tiles.

Products marked ABS (ABS) comprise a new generation of fine and matt surface finish microstructures that provide a better anti-slip resistance rating of R10/B. Surfaces with better anti-slip resistance naturally require more attention in terms of maintenance, including the use of professional detergents.

In the RAKO HOME and RAKO OBJECT assortment, there are goods with the ABS surface, marked with (ABS).

FR Il s'agit de l'une des caractéristiques superficielles les plus importantes des carreaux céramiques qui détermine l'adéquation de l'utilisation du type sélectionné des carreaux pour des locaux concrets et elle assure un mouvement sûr des personnes. Les exigences sur l'antidérapage des sols sont déterminées par les règlements nationaux, en République tchèque, l'ordonnance 146/2024 du JO et les normes ČSN 74 4505 et ČSN 72 5191 ; pour la précision il convient d'utiliser les règlements de sécurité ASR 1.5:2022, qui peuvent être recommandés pour les bâtiments en toute l'Europe (voir le tab. 4). En Allemagne, les exigences sont fixées par Technische Regel für Arbeitsstätten – ASR 1.5:2022: Fußböden

La résistance au glissement des carreaux de sol en grès est évaluée d'après les méthodes données dans les normes suivantes:

- **EN 16165:2022** Détermination de la résistance au glissement des surfaces piétonnes - Méthodes d'évaluation, Détermination de l'antidérapage
- **DIN 51 097** Détermination des propriétés de glissement pour les surfaces humides, sur lesquelles on marche pieds nus
- **DIN 51 130** Détermination des propriétés de glissement pour les locaux de travail et surfaces avec le danger élevé de glissement
- **ASR A1.5: 2022** Prescription de sécurité
- **ANSI A137.1** Détermination de la résistance au glissement selon la norme en vigueur en Amérique du Nord



Avec les exigences élevées à la résistance au glissement, on lie souvent l'exigence sur la capacité de la surface structurée à absorber dans ses creux un certain volume de liquide déversé sur le sol (ceci est exigé le plus souvent dans des locaux de traitement des graisses etc.) Cette capacité est évaluée d'après la norme DIN 51 130 par le volume des creux exprimé en cm³ sur la surface de carrelage 1 dm² (espace de drainage) et elle est marquée par lettre V avec la valeur nominale correspondante (p. ex. V4).

Les tableaux suivants donnent un aperçu des valeurs antidérapantes testées des dalles RAKO HOME et RAKO OBJECT.

Produits marqués avec ABS (ABS) proposent une nouvelle génération de surfaces dotées d'une microstructure fine et mate qui permet d'obtenir une meilleure résistance à la glissance R10/B. Les surfaces hautement antidérapantes nécessitent bien entendu un soin particulier lors de l'entretien, y compris l'utilisation de produits de nettoyage professionnels.

Les produits de l'assortiment RAKO HOME et RAKO OBJECT avec surface ABS sont marqués de l'icône (ABS).



Für Arbeitsstätten sind ausschließlich rutschhemmende Fliesen nach 146/2024 GBL., ČSN 72 5191 und DIN 51 130:2014-02 geeignet. Ermittelt werden die Kategorien über die Messung auf einer schiefen Ebene nach festgelegtem Winkel.

According to Degree 146/2024 Coll., ČSN 72 5191 and DIN 51 130:2014-02, anti-slip floor tiles according to their slip angle for **work floors** should be used.

Rutschwinkel Slip angle	Bezeichnung Identifier	Anwendungsbereich Application
6 – 10°	R9	Eingangsbereiche, Innentrepfen, Toiletten in öffentlichen Bereichen und Pausenräume, Speiseräume, Verkaufs- und Kundenräume Entrance areas, interior staircases, toilets in public areas and break rooms, dining rooms, sales and customer rooms
10 – 19°	R10	Umkleide- und Waschräume, Aufwärm- und Teeküchen, Verkaufsstellen für Verpackte Waren, Toiletten und Waschräume in Schulen und Kindergärten Changing rooms and washrooms, warm-up and tea kitchens, sales points for packaged goods, toilets and washrooms in schools and kindergartens
19 – 27°	R11	Eingangsbereiche und Treppen außen, Küchen für Gemeinschaftsverpflegung, KFZ-Werkstattbereiche Entrance areas and staircases outside, kitchens for communal catering, vehicle workshop areas
27 – 35°	R12	Spülräume, Pumpenräume, Feuerwehrrhäuser Washrooms, pump rooms, fire stations
> 35°	R13	Schlachtereien, Raffinerien, Lederherstellung Slaughterhouses, refineries, leather production



Für Boden, die **barfuß begangen** werden, sind nach der Verordnung 268/2009 GBL., CEN/TS 16 165:2022, EN 13451-1, DIN 51 097 und ČSN 72 5191 die Rutschfestigkeitsklassen nach dem Verwendungsbereich festgelegt:

For floors for **barefoot** walking, according to Degree 146/2024 Coll., EN 16165:2022, EN 13451-1, DIN 51 097 and ČSN 72 5191, there are the following slip resistance classes according to the fields of application.

Rutschwinkel Slip angle	Bezeichnung Identifier	Anwendungsbereich Application
≥ 12°	A	vorwiegend trockene Gänge, Umkleieräume, Umkleidekabinen, Swimmingpool-Boden von 80 bis 135 cm, Planschbecken, trockene Saunen... mainly dry corridors, changing rooms, dressing rooms, bottoms of pools from 80 up to 135 cm, paddling pools, and dry saunas...
≥ 18°	B	öffentliche Duschen, Swimmingpool-Umgänge, Planschbecken, Treppen, Swimmingpool-Böden bis 80 cm, Swimmingpool-Böden mit Neigung bis 8° und Tiefe bis 135 cm, Desinfektionsbehälter, Dampfsaunen... public showers, pool decks, paddling pools, stairs, bottoms of pools up to 80 cm, bottoms of pools with a slope up to 8° and the maximum depth of 135 cm, disinfection tanks, steam saunas...
≥ 24°	C	Treppen unter Wasser, schräge Swimmingpool-Ränder, Startblöcke, Swimmingpool-Böden mit Neigung über 8° und Tiefe bis 135 cm, Spielplatz- und Leitertrittflächen... underwater stairs, inclined pool sides, starting blocks, bottoms of pools with a slope over 8° and the maximum depth of 135 cm, walking areas of chute slides, and ladders...

Rutschhemmende Eigenschaften keramischer Fliesen RAKO OBJECT gem. EN 16165:2022
Anti-slip characteristics of ceramic tiles RAKO OBJECT according to EN 16165:2022)

Programm Serie	Reibungskoeffizient Sliding friction coefficient		DIN 51 130		DIN 51 097
	μ bei Trockenheit (dry)	μ bei Nässe (wet)	R	V [cm³/dm²]	(A, B, C)
Block (ABS)	≥ 0,6	≥ 0,5	R10		B
Block lappato	≥ 0,5	≥ 0,4	R9		-
Compila (ABS) (DAA..., DAK...)	≥ 0,6	≥ 0,5	R10		B
Compila (DAF...)	≥ 0,6	≥ 0,5	R11		B
Kaamos (DAA..., DAK...)	≥ 0,6	≥ 0,5	R10		A
Kaamos (DAK12..., DDM06...)	≥ 0,6	≥ 0,5	R10		B
Kaamos Industrial	≥ 0,6	≥ 0,5	R10		A
Kaamos Outdoor	≥ 0,7	≥ 0,7	R11		B
TAURUS (Oberfläche surface)					
matt	≥ 0,6	≥ 0,5	R10		B
Relief SR1	≥ 0,7	≥ 0,6	R11	V4	B
Relief SR2	≥ 0,7	≥ 0,6	R12	V4	B
Relief SR4	≥ 0,7	≥ 0,6	R12	V4	C
Relief SR7	≥ 0,7	≥ 0,6	R11		B
Relief SR20	≥ 0,7	≥ 0,6	R13	V8	C
Relief SRM	≥ 0,7	≥ 0,6	R12		B
Formteile für Sehschwache und Blinde* Special tiles for visually impaired persons*	≥ 0,7	≥ 0,6	R11		A
ColorTWO a POOL (Oberfläche surface)					
GAK (ABS)	≥ 0,6	≥ 0,5	R10		B
GAA...	≥ 0,5	≥ 0,3	-		-
GAF	≥ 0,6	≥ 0,5	R10		B
Relief GRN	≥ 0,6	≥ 0,5	R10		B
Relief GRS	≥ 0,6	≥ 0,5	R10		B
Relief GRH	≥ 0,7	≥ 0,5	-		C
Stufe Step tile, step tile flat, signal radius POOL (XP...)	≥ 0,7	≥ 0,6	-		C
Beckenrandstein Edging tile POOL (XP...)	≥ 0,7	≥ 0,6	-		C
Muldenrinne Gutter tile POOL (XP...)	≥ 0,7	≥ 0,6	-		C
Mosaik matt Mosaic matt 5 x 5 cm (GDM05...)	≥ 0,5	≥ 0,5	-		-
Mosaik matt Mosaic matt 2,5 x 2,5 cm (GDM02...)	≥ 0,5	≥ 0,5	-		-

*Bestimmt nur für Blindenleit- und Warnstreifen | Intended only for guiding and warning strips for visually impaired persons
 Rutschhemmender Charakter der Fliesen erschwert die Reinigung | Anti-slip character of floor tiles more demanding on cleaning

Für besonders hohe Rutschhemmungen sind Reliefoberflächen notwendig. In Bereichen in denen Feststoffe oder gleitfördernde Flüssigkeiten verarbeitet werden, müssen, nach ASR 1.5:2022., Produkte mit Verdrängungsraum eingesetzt werden. Das Verdrängungsvolumen wird nach Norm DIN 51130 durch den Buchstaben V hinter der Rutschhemmung angezeigt. Das Volumen wird in cm³/dm² bemessen (z.B. V4 - 4 cm³/dm²) und gibt an, wie groß der Hohlraum durch das Relief entsteht.

Der Reibungskoeffizient wird durch eine Gleitreibungsmessung mit einem Pendel oder mobilen Tribometer ermittelt. (Tabelle 4)

For floors with high requirements for slip resistance, the ASR 1.5:2022 regulation recommends appropriate embossment, where, for example in food industry or industrial kitchens, the embossed surface of tiles must be able to accommodate a certain amount of fat or other substances into its cavities. Depending on the type and height of the embossment, a so-called discharge volume in cm³ per 1 dm² is defined in accordance with DIN 51 130, and designated by the V letter and the corresponding numerical value (for example: V4), see the Table 3. For measured anti-slip values according to the pendulum or mobile tribometr test method (DCOF) for North America, see Table 4.

Tab. 3

Min. Druckraum in cm³/dm² Min. discharge volume in cm³/dm²	Bezeichnung Identifier
> 4	V4
> 6	V6
> 8	V8
> 10	V10

Tab. 4

Produktgruppe Group of goods	Pendulum (AS 4586)	Pendulum (EN 16165:2021)	DCOF (ANSI A137.1)
RAKO Outdoor 60 x 60 x 2 60 x 120 x 2	Klasse class 3	> 36	> 0,7

Rutschhemmende Eigenschaften keramischer Fliesen RAKO HOME gem. EN 16165:2022
Anti-slip characteristics of ceramic tiles RAKO HOME according to EN 16165:2022

Rutschhemmende Eigenschaften Antislip characteristics	Reibungskoeffizient Sliding friction coefficient		DIN 51 130	DIN 51 097
	μ bei Trockenheit (dry)	μ bei Nässe (wet)	R	(A, B, C)
Serie Serie				
Alba (DAR...)	≥ 0,6	≥ 0,5	R10	A
Alba (DDM...)	≥ 0,6	≥ 0,5	R10	B
Alba (DAP..., DDPSE...)	≥ 0,6	≥ 0,5	R9	-
Base (DAK...)	≥ 0,5	≥ 0,3	R9	A
Base (DDM...)	≥ 0,6	≥ 0,5	R10	A
Betonico (ABS)	≥ 0,6	≥ 0,5	R10	B
Betonico (DAF...)	≥ 0,6	≥ 0,5	R11	B
Betonico Outdoor	≥ 0,7	≥ 0,7	R11	B
Blend	≥ 0,5	≥ 0,5	R9	A
Blend (DDM...)	≥ 0,5	≥ 0,5	R10	A
Board (DAK...)	≥ 0,6	≥ 0,5	R9	A
Board (DDM06..., DDPSE...)	≥ 0,6	≥ 0,5	R10	A
Bricola (ABS)	≥ 0,6	≥ 0,5	R10	B
Bricola Outdoor	≥ 0,7	≥ 0,7	R11	B
Castone (ABS)	≥ 0,6	≥ 0,5	R10	B
Castone Outdoor	≥ 0,7	≥ 0,7	R11	B
Cava (DAK...)	≥ 0,5	≥ 0,5	R9	A
Cava (DAL..., DDL06...)	≥ 0,5	≥ 0,3	-	-
Cava (DDM...)	≥ 0,5	≥ 0,5	R10	B
Cemento (DAK...)	≥ 0,6	≥ 0,5	R9	-
Cemento (DDM...)	≥ 0,6	≥ 0,5	R10	B
Cemento (DDPSE...)	≥ 0,6	≥ 0,5	R10	A
Como (DAR..., DDP...)	≥ 0,6	≥ 0,5	R9	A
Como (DDM...)	≥ 0,6	≥ 0,5	R10	A
Concept	≥ 0,6	≥ 0,5	R9	-
Core (DAR..., DDM...) (ABS)	≥ 0,6	≥ 0,5	R10	B
Core (DAG...)	≥ 0,7	≥ 0,6	R11	C
Core Outdoor	≥ 0,7	≥ 0,7	R11	B
Craft	≥ 0,6	≥ 0,5	R10	B
Date (DAR..., DDM...) (ABS)	≥ 0,6	≥ 0,5	R10	B
Date (DAF...)	≥ 0,6	≥ 0,5	R11	B
Date (DAE...)	≥ 0,6	≥ 0,5	R12	B
Date (DAG...)	≥ 0,7	≥ 0,6	R11	C
Deco	≥ 0,6	≥ 0,5	R9	-
Era	≥ 0,6	≥ 0,5	R9	A
Era (DDM...)	≥ 0,7	≥ 0,6	R10	B
Extra (ABS)	≥ 0,6	≥ 0,5	R10	B
Flash (DAK...)	≥ 0,5	≥ 0,5	R9	A
Flash (DDM...)	≥ 0,5	≥ 0,5	R10	B
Fly (ABS)	≥ 0,6	≥ 0,5	R10	B
Form (DAA...)	≥ 0,6	≥ 0,5	R9	A
Form (DDM..., DDR...)	≥ 0,6	≥ 0,5	R10	A
Garda	≥ 0,6	≥ 0,5	R9	A
Levante (DAK...)	≥ 0,6	≥ 0,5	R9	A
Levante (DDM...)	≥ 0,6	≥ 0,5	R10	B
Limestone (DAK...)	≥ 0,5	≥ 0,5	R9	A
Limestone (DAR..., DDM...)	≥ 0,6	≥ 0,5	R10	A
Limestone (DAL...)	≥ 0,5	≥ 0,3	-	-
Linka (ABS)	≥ 0,6	≥ 0,5	R10	B
Mixtone (ABS)	≥ 0,6	≥ 0,5	R10	B
Mixtone Outdoor	≥ 0,7	≥ 0,7	R11	B
Onyx (DAK...)	≥ 0,5	≥ 0,5	R9	A
Onyx (DDM...)	≥ 0,5	≥ 0,5	R10	B
Onyx (DAL..., DDL...)	≥ 0,5	≥ 0,3	-	-
Piazzetta (ABS)	≥ 0,6	≥ 0,5	R10	B
Piazzetta Outdoor	≥ 0,7	≥ 0,7	R11	B
Pino (DAR...)	≥ 0,6	≥ 0,5	R9	A
Pino (DDM...)	≥ 0,6	≥ 0,5	R10	B
Pino Outdoor	≥ 0,7	≥ 0,7	R11	B
Plank (DAR...)	≥ 0,6	≥ 0,5	R9	A
Plank (DDM...)	≥ 0,6	≥ 0,5	R10	B
Plywood (ABS)	≥ 0,6	≥ 0,5	R10	B
Porfido (ABS)	≥ 0,6	≥ 0,5	R10	B
Quarzit (DAK...)	≥ 0,5	≥ 0,5	R9	A
Quarzit (DAR..., DDM...)	≥ 0,6	≥ 0,5	R10	B
Quarzit Outdoor (60x120x2)	≥ 0,7	≥ 0,7	R11	B
Rave (ABS)	≥ 0,6	≥ 0,5	R10	B
Rave Outdoor	≥ 0,7	≥ 0,7	R11	B
Rebet (DAK..., DAA...)	≥ 0,6	≥ 0,5	R9	A
Rebel (DDM..., DAK11...)	≥ 0,6	≥ 0,5	R10	B
Rebel Outdoor	≥ 0,7	≥ 0,7	R11	B
Saloon (DAK...)	≥ 0,6	≥ 0,5	R9	A
Saloon (DDM...)	≥ 0,6	≥ 0,5	R10	B
Shade (ABS)	≥ 0,6	≥ 0,5	R10	B
Siena	≥ 0,6	≥ 0,4	R9	-
Siena (DDP...)	≥ 0,6	≥ 0,5	R9	A
Touch (DAK...)	≥ 0,6	≥ 0,5	R9	A
Touch (DDM...)	≥ 0,6	≥ 0,5	R10	B
Vals (ABS)	≥ 0,6	≥ 0,5	R10	B
Vals Outdoor	≥ 0,7	≥ 0,7	R11	B
Via	≥ 0,6	≥ 0,5	R9	A
Via (DDM...)	≥ 0,6	≥ 0,5	R10	B

DE Nationale Verordnungen und Normen regeln die Anforderungen an die Rutschhemmung von Bodenbelägen. Die Fußböden müssen eben, regelmäßig gereinigt und mit vorgeschriebener Rutschhemmstufe ausgestattet sein. Für öffentliche Bereiche sind die rutschhemmenden Werte durch die Verordnung Technische Regel für Arbeitsstätten – ASR A1.5: 2022: Fußböden festgelegt. Technische Regel für Arbeitsstätten – ASR A1.5: 2022: Fußböden

0	Allgemeine Arbeitsräume und -bereiche*)		9.3	Küchen für Gemeinschaftsverpflegung in Krankenhäusern, Kliniken	R12	15	Lederherstellung, Textilien		27.6	Wärmegewöhnungsraum	R11
0.1	Eingangsbereiche, innen**)	R9				15.1	Wasserwerkstatt in Gerbereien	R13	27.7	Leitstand	R 9
0.2	Eingangsbereiche, außen	R11 oder R10 V4	9.4	Großküchen für Gemeinschaftsverpflegung in Mensen, Kantinen und Fernküchen	R12	15.2	Räume mit Entfleischmaschinen	R13 V10			
0.3	Treppen, innen***)	R9				15.3	Räume mit Leimlederanfall	R13 V10	28	Schulen und Kindertagesstätten	
0.4	Außentreppen	R11 oder R10 V4	9.5	Aufbereitungsküchen (Fast Food-Küchen, Imbissbetriebe)	R12	15.4	Fetträume für Dichtungsherstellung	R12	28.1	Eingangsbereiche, Flure, Pausenhallen	R9
0.5	Schrägrampen, innen***) (ab 3 % Steigung; z.B. Rollstuhlrampen, Ausgleichsschragen, Transportwege)	Eine R-Gruppe höher als für den Zugangsbelag erforderlich V-Wert des Zugangsbelags, falls zutreffend	9.6	Auftau- und Anwärmküchen	R10	15.5	Färbereien für Textilien	R11	28.2	Unterrichtsräume, Gruppenräume	R9
			9.7	Kaffee- und Teeküchen, Küchen in Hotels-Garni, Stationsküchen	R10				28.3	Treppen	R9
			9.8	Spülräume		16	Lackierereien		28.4	Toilettenräume, Waschräume	R10
			9.8.1	Spülräume zu 9.1, 9.4, 9.5	R12 V4	16.1	Nassschleifbereiche	R12 V10	28.5	Lehrküchen in Schulen	siehe Nummer 9.2, 9.6 oder 9.7
			9.8.2	Spülräume zu 9.2	R11	16.2	Pulverbeschichtung	R11			
			9.8.3	Spülräume zu 9.3	R12	16.3	Lackierung	R10			
			9.9	Speiseräume, Gasträume, Kantinen einschließlich Bedienung- und Serviergängen	R9	17	Keramische Industrie		28.6	Küchen in Kindertageseinrichtungen (siehe auch Nummer 9)	R10
0.6	Sanitärräume	R9	9.10	Thekenbereich, Schankbereich	R10	17.1	Nassmühlen (Aufbereitung keramischer Rohstoffe)	R11	28.7	Maschinenräume für Holzbearbeitung	R10
0.6.1	Toilettenräume	R9				17.2	Mischer, Umgang mit Stoffen wie Teer, Pech, Graphit, Kunstharzen	R11 V6	28.8	Fachräume für Werken	R10
0.6.2	Umkleide- und Waschräume	R10	10	Kühlräume, Tiefkühlräume, Kühlhäuser, Tiefkühlhäuser		17.3	Pressen (Formgebung), Umgang mit Stoffen wie Teer, Pech, Graphit, Kunstharzen	R11 V6	28.9	Pausenhöfe	R11 oder R10 V4
0.7	Pausenräume (z.B. Aufenthaltsraum, Betriebskantinen)	R9	10.1	für unverpackte Ware	R12	17.4	Gieß-, Druckgussbereiche	R12	29	Geldinstitute	
0.8	Erste-Hilfe-Räume und vergleichbare Einrichtungen (siehe ASR A4.3)	R9	10.2	für verpackte Ware	R11	17.5	Glasierbereiche	R12	29.1	Schallerräume	R9
1	Herstellung von Margarine, Speisefett, Speiseöl		11	Verkaufsstellen, Verkaufsräume		18	Be- und Verarbeitung von Glas und Stein		30	Betriebliche Verkehrswege in Außenbereichen	
1.1	Fettschmelzen	R13 V6	11.1	Warenannahme Fleisch		18.1	Steinsägerei, Steinschleiferei	R11	30.1	Gehwege	R11 oder R10 V4
1.2	Speiseölraffinerie	R13 V4	11.1.1	für unverpackte Ware (z. B. lose in Transportboxen)	R11	18.2	Glasformung von Hohlglas, Behälterglas	R11	30.2	Laderampen	
1.3	Herstellung und Verpackung von Margarine	R12	11.1.2	für verpackte Ware	R10	18.3	Schleifereibereiche für Hohlglas und Flachglas	R11	30.2.1	überdacht	R11 oder R10 V4
1.4	Herstellung und Verpackung von Speisefett, Abfüllen von Speiseöl	R12	11.2	Warenannahme Fisch	R11	18.4	Isolierglasfertigung, Umgang mit Trockenmittel	R11 V6	30.2.2	nicht überdacht	R12 oder R11 V4
2	Milchbe- und -verarbeitung, Käseherstellung		11.3	Bedienungsgang für Fleisch und Wurst		18.5	Verpackung, Versand von Flachglas, Umgang mit Antihafmittel	R11 V6	30.3	Schrägrampen (ab 3 % Steigung; z.B. für Rollstühle, Ladebrücken)	R12 oder R11 V4
2.1	Frischmilchverarbeitung einschließlich Buttereie	R12	11.3.1	für unverpackte Ware	R11	18.6	Ätz- und Säurepolieranlagen für Glas	R11	30.4	Betankungsbereiche	
2.2	Käsefertigung, -lagerung und Verpackung	R11	11.3.2	für verpackte Ware	R10	19	Betonwerke		30.4.1	überdacht	R11
2.3	Speiseeisfabrikation	R12	11.4	Bedienungsgang für Brot- und Backwaren, unverpackte Ware.	R10	19.1	Betonwaschplätze	R11	30.4.2	nicht überdacht	R12
3	Schokoladen- und Süßwarenherstellung		11.5	Bedienungsgang für Molkerei- und Feinkostzeugnisse, unverpackte Ware	R10	20	Lagerbereiche		31	Parkbereiche	
3.1	Zuckerkochei	R12	11.6	Bedienungsgang für Fisch		20.1	Lagerbereiche für Öle und Fette, die zur Teilentnahme vorgesehen sind (z. B. in Werkstätten)		31.1	Garagen, Hoch- und Tiefgaragen ohne Witterungseinfluss****)	R10
3.2	Kakaoherstellung	R12	11.6.1	für unverpackte Ware	R12	20.2	Lagerbereiche für verpackte Lebensmittel	R12 V6	31.2	Garagen, Hoch- und Tiefgaragen mit Witterungseinfluss	R11 oder R10 V4
3.3	Rohmassenherstellung	R11	11.6.2	für verpackte Ware	R11	20.3	Lagerbereiche im Freien	R10	31.3	Parkflächen im Freien	R11 oder R10 V4
3.4	Eintafelei, Hohlkörper- und Pralinenfabrikation	R11	11.7	Bedienungsgänge, ausgenommen Nummern 11.3 bis 11.6	R9	21	Chemische und thermische Behandlung von Eisen und Metall		32	Bäder	
4	Herstellung von Backwaren (Bäckereien, Konditoreien, Dauerbackwaren-Herstellung)		11.8	Fleischvorbereitungsraum		21.1	Beizereien	R12	32.1	Einzel- und Sammelumkleideräume	R10
4.1	Teigbereitung	R11	11.8.1	zur Fleischbearbeitung, ausgenommen Nummer 5	R12 V8	21.2	Härtereien	R12	32.2	Sauna - und Ruhebereiche	R10
4.2	Räume, in denen vorwiegend Fette oder flüssige Massen verarbeitet werden	R12	11.8.2	zur Fleischverarbeitung, ausgenommen Nummer 5	R11	21.3	Laborräume	R11	32.3	Duschräume und Duschbereiche	R10
4.3	Spülräume	R12 V4	11.9	Blumenbinderäume und -bereiche	R11	22	Metallbe- und -verarbeitung, Metall-Werkstätten		32.4	Beckenumgänge	R10
5	Schlachtung, Fleischbearbeitung, Fleischverarbeitung		11.10	Verkaufsstellen mit Backöfen		22.1	Galvanisierräume	R12			
5.1	Schlachthaus	R13 V10	11.10.1	zum Herstellen von Backware	R11	22.2	Graugussbearbeitung	R11 V4			
5.2	Kuttleraum, Darmschleimerei	R13 V10	11.10.2	zum Aufbacken vorgefertigter Backware	R10	22.3	mechanische Bearbeitungsbereiche (z.B. Dreherei, Fräseerei), Stanzerei, Presserei, Zieherei (Rohre, Drähte)	R11			
5.3	Fleischzerlegung	R13 V8	11.11	Verkaufsbereiche mit Fritteusen oder Grillanlagen	R12 V4	22.4	mechanische Bearbeitungsbereiche mit erhöhter Öl-Schmiermittelbelastung	R11 V4			
5.4	Wurstküche	R13 V8	11.12	Verkaufsräume, Kundenräume	R9	22.5	Teilreinigungsbereiche, Abdämpfbereiche	R12			
5.5	Kochwurstabteilung	R13 V8	11.13	Vorbereitungsbereiche für Lebensmittel zum SB-Verkauf (ausgenommen Fleisch, Fisch und Wurst)	R10	23	Werkstätten für Fahrzeug-Instandhaltung				
5.6	Rohwurstabteilung	R13 V6	11.14	Kassenbereiche, Packbereiche	R9	23.1	Instandsetzungs- und Wartungsräume	R11			
5.7	Wursttrockenraum	R12	11.15	Verkaufsbereiche im Freien	R11 oder R10 V4	23.2	Arbeits- und Prüfgrube	R12 V4			
5.8	Darmlager	R12	12	Räume des Gesundheitsdienstes/der Wohlfahrtspflege		23.3	Waschhalle, Waschplätze	R11 V4			
5.9	Pökelei, Räucherei	R12	12.1	Desinfektionsräume (nass)	R11	24	Werkstätten für das Instandhalten von Luftfahrzeugen				
5.10	Geflügelverarbeitung	R12 V6	12.2	Vorreinigungsbereiche der Sterilisation	R10	24.1	Flugzeughallen	R11			
5.11	Aufschnitt- und Verpackungsabteilung	R12	12.3	Fäkalienräume, Ausgussräume, unreine Pflegearbeitsräume	R10	24.2	Werfthallen	R12			
5.12	Handwerksbetrieb mit Verkauf	R12 V8 ****)	12.4	Sektionsräume	R10	24.3	Waschplätze	R11 V4			
6	Be- und Verarbeitung von Fisch, Feinkostherstellung		12.5	Räume für medizinische Bäder, Hydrotherapie, Fango-Aufbereitung	R11	25	Abwasserbehandlungsanlagen				
6.1	Be- und Verarbeitung von Fisch	R13 V10	12.6	Waschräume von OP's, Gipsräume	R10	25.1	Pumpenräume	R12			
6.2	Feinkostherstellung	R13 V6	12.7	Sanitäre Räume, Stationsbäder	R10	25.2	Räume für Schlammentwässerungsanlagen	R12			
6.3	Mayonnaiseherstellung	R13 V4	12.8	Räume für medizinische Diagnostik und Therapie, Massageräume	R9	25.3	Räume für Rechenanlagen	R12			
7	Gemüsebe- und -verarbeitung		12.9	OP-Räume	R9	25.4	Standplätze von Arbeitsplätzen, Arbeitsbühnen und Wartungspodeste	R12			
7.1	Sauerkrautherstellung	R13 V6	12.10	Stationen mit Krankenzimmern und Flure	R9	26	Feuerwehrrhäuser				
7.2	Gemüsekonservenherstellung	R13 V6	12.11	Praxen der Medizin, Tageskliniken	R9	26.1	Fahrzeug-Stellplätze	R12			
7.3	Sterilisierräume	R11	12.12	Apotheken	R9	26.2	Räume für Schlauchpflegeeinrichtungen	R12			
7.4	Räume, in denen Gemüse für die Verarbeitung vorbereitet wird	R12 V4	12.13	Laborräume	R9	27	Funktionsräume in der Atemschutzübungsanlage				
			12.14	Friseursalons	R9	27.1	Vorbereitungsraum	R10			
8	Nassbereiche bei der Nahrungsmittel- und Getränkeherstellung (soweit nicht besonders erwähnt)		13	Wäscherei		27.2	Konditionsraum	R10			
8.1	Lagerkeller, Gärkeller	R10	13.1	Räume mit Durchlaufwaschmaschinen (Waschröhren) oder mit Waschscheudermaschinen	R9	27.3	Übungsraum	R11			
8.2	Getränkeabfüllung, Fruchtsaftherstellung	R11	13.2	Räume mit Waschmaschinen, bei denen die Wäsche tropfnass entnommen wird	R11	27.4	Schleuse	R10			
9	Küchen, Speiseräume		13.3	Räume zum bügeln und mangeln	R9	27.5	Zielraum	R11			
9.1	Gastronomische Küchen (Gaststättenküchen, Hotelküchen)	R12	14	Kraftfutterherstellung							
9.2	Küchen für öffentliche Speisung in Heimen, Schulen, Kindergärten, Sanatorien	R11	14.1	Trockenfutterherstellung	R11						
			14.2	Kraftfutterherstellung unter Verwendung von Fett und Wasser	R11 V4						

*) Für Fußböden in barfuß begangenen Nassbereichen siehe DGUV-Information „Bodenbeläge für nassbelastete Barfußbereiche“ (DGUV Information 207-006)

**) Eingangsbereiche gemäß Nummer 0.1 sind alle Bereiche, die durch die Eingänge direkt aus dem Freien betreten werden und in die Feuchtigkeit von außen hereingetragen werden kann (siehe auch Abschnitt 6 Absatz 3, Verwendung von Schmutz- und Feuchtigkeitsaufnehmern). Für anschließende Bereiche oder andere großflächige Räume ist Abschnitt 4 Absatz 10 zu beachten.

***) Treppen, Rampen gemäß Nummer 0.3 und 0.5 sind diejenigen, auf die Feuchtigkeit von außen hineingetragen werden kann. Für anschließende Bereiche ist Abschnitt 4 Absatz 10 zu beachten.

****) Wurde überall ein einheitlicher Bodenbelag verlegt, kann der Verdrängungsraum aufgrund einer Gefährdungsanalyse (unter Berücksichtigung des Reinigungsverfahrens, der Arbeitsabläufe und des Anfalls an gleitfördernden Stoffen auf den Fußboden) bis auf V4 gesenkt werden.

*****) Die Fußgängerbereiche, die nicht von Rutschgefahr durch Witterungseinflüsse, wie Schlagregen oder eingeschleppte Nässe betroffen sind.

Die Messergebnisse der Prüfmethode zur Bestimmung der Rutschhemmung von Bodenbelägen im Betriebszustand nach E DIN 51131 (Gleitreibungskoeffizient) können nicht direkt mit den Messergebnissen der Prüfung nach DIN 51130 (Neigungswinkel auf der Schiefen Ebene) verglichen werden. Der Gleitreibungskoeffizient kann deshalb nicht zur Einordnung in eine R-Gruppe herangezogen werden.

DE Optische Eigenschaften von Verkleidungselementen – LRV (Hellbezugswert)

Die Eigenschaft keramischer Produkte Licht zu reflektieren oder zu absorbieren, wird mit dem Lichtreflexionswert (LRV light reflection value) gemessen. Die ÖNORM B 1600:2012 und die DIN-Norm 18040 definieren feste Werte zur Erhöhung der Sicherheit in öffentlichen Gebäuden. Für Bodenbeläge ist beispielsweise bei Stufenkantenmarkierungen für Treppen oder Bodenindikatoren bei der hellsten Farbe ein LRV von mind. 50 gefordert. Der aus der Kombination von hellen und dunklen Produkten entstehende Kontrast, kann zur Erhöhung der Sicherheit, zur Warnung oder zur Orientierung genutzt werden. Der Kontrast muss mind. den Wert 0,4 erreichen.

Der Lichtkontrast wird mit der sogenannten Michelson-Formel errechnet:

$$K = (LRV1 - LRV2) / (LRV1 + LRV2)$$

(Hinweis: LRV1 = höherer Wert des Lichtreflexionskoeffizienten, LRV2 = niedrigerer Wert)

Der tatsächliche LRV eines Produkts kann produktionsbedingt variieren und sollte daher Chargenbezogen ermittelt werden. Die Messung erfolgt mit dem Spektralphotometer nach CIE 1931.

EN Optical characteristics of tiling elements – LRV and Light contrast

The capacity of ceramic tiling elements to reflect or absorb light is a consideration for certain applications using LRV coefficient (Light reflectance value). We also use a contrast of light and dark areas on the floor to improve orientation, so called Light contrast. Requirements for safe orientation in buildings are specified by the standard ÖNORM B 1600:2012 and DIN 18040. The light contrast (K) is determined by DIN 32 984 which requires a minimal value 0.4.

Light contrast calculation:

$$K = (LRV1 - LRV2) / (LRV1 + LRV2)$$

(note: K= light contrast; LRV1= higher value of light reflection, when LRV ≥ 50; LRV2= lower value)

LRV values are only informative and can change in relation to the hue of individual batches.

FR Propriétés optiques des éléments de revêtement – LRV

Pour des applications données, il est nécessaire d'évaluer la performance des éléments de revêtement en céramique quant à la réflexion ou l'absorption de l'énergie lumineuse. Ces paramètres sont par exemple définis dans la norme ÖNORM B 1600:2012 et DIN 18040 visant à améliorer l'orientation dans les bâtiments publics par le contraste prescrit des zones claires et sombres en utilisant le coefficient de réflexion de la lumière (Light Reflectance Value) des surfaces individuelles. Le contraste lumineux est réglé par une norme DIN 32 984 nécessitant un minimum de 0,4.

Le contraste lumineux:

$$K = (LRV1 - LRV2) / (LRV1 + LRV2)$$

(note: K=contraste lumineux; LRV1 = valeur supérieure à la condition que LRV ≥ 50; LRV2=valeur inférieure)

Les valeurs LRV sont indicatives et peuvent varier en fonction du dosage des nuances de couleur.

Die Werte LRV für ausgewählte Belagselemente gemessen mit dem Spektrofotometer gemäß CIE 1931:

LRV values for selected tiling elements are measured using a spectrophotometer according to CIE 1931:

Valeurs LRV pour les éléments de revêtement donnés, mesurées avec un spectrophotomètre conformément à CIE 1931:

RAKO HOME		
Serie	Light reflectance values, glazed floor tiles	
Betonico	DAxxx790	61
Betonico	DAxxx791	22
Betonico	DAxxx792	15
Betonico	DAxxx793	45
Betonico	DAxxx794	38
Extra	DARxx720	55
Extra	DARxx721	26
Extra	DARxx722	58
Extra	DARxx723	41
Extra	DARxx724	20
Extra	DARxx725	9
Porfido	DAxxx810	66
Porfido	DAxxx811	39
Porfido	DAxxx812	9
Porfido	DAxxx813	54
Porfido	DAxxx814	26
Porfido	DAxxx815	18
Rebel	DAxxx740	54
Rebel	DAxxx741	43
Rebel	DAxxx742	22
Rebel	DAxxx743	52
Quarzit	DAxxx735	44
Quarzit	DAxxx736	13
Quarzit	DAxxx737	39
Quarzit	DAxxx738	16
Quarzit	DAxxx739	8

Serie Compila Light reflectance values								
10x30			Glazed floor tiles			Wall tiles 30 x 60 cm		
Nude	GARJD860	48	Paper	DAxxx864	63	Nude	WAxxx860	46
Aqua	GARJD861	52	Cement	DAxxx865	44	Aqua	WAxxx861	50
Mint	GARJD862	45	Shadow	DAxxx866	17	Mint	WAxxx862	41
Botanic	GARJD863	8	Taupe	DAxxx867	32	Botanic	WAxxx863	13
Paper	GARJD864	74	Sand	DAxxx868	39	Paper	WAxxx864	66
Cement	GARJD865	49	Cotto	DAxxx869	15	Cement	WAxxx865	46
Taupe	GARJD867	35	Storm	DAxxx870	8	Shadow	WAxxx866	21
Cotto	GARJD869	10	Coal	DAxxx871	10	Taupe	WAxxx867	35
Storm	GARJD870	6						

RAKO OBJECT	Light reflectance values ColorONE, ColorTWO, POOL (matt)		Light reflectance values ColorONE, ColorTWO, POOL (glossy)	
RAL 0304060	WAxxx373 GAAxx459	15	WAxxx363 GAAxx359	17
RAL 0506080	WAxxx460 GAAxx460	34	WAAxx450	29
RAL 0607050	WAxxx282 GAAxx150 GAAxx750	48	WAAxx272	48
RAL 0858070	WAxxx222 GAAxx142 GAAxx742	57	WAAxx201	60
RAL 0908040	WAxxx221 GAAxx124	61	WAAxx200	64
RAL 0958070	WAxxx464 GAAxx464	60	WAAxx454	58
RAL 1208050	WAxxx465 GAAxx465	54	WAAxx455	56
RAL 1306050	WAxxx466 GAAxx466	31	WAAxx456	29
RAL 1907025	WAxxx467 GAAxx467 GAAxx767	40	WAAxx457	39
RAL 2408015	WAxxx540 GAAxx003 GAAxx703	59	WAAxx550	61
RAL 2606025	WAxxx541 GAAxx127	28	WAAxx551	29
RAL 2902035	WAxxx545 GAAxx005 GAAxx555 GAAxx755	6	WAAxx555	6
RAL 0001500	WAAxx732 GAAxx048	5	WAAxx779 GAAxx548	5
RAL 0004000	WAAxx765 GAAxx248	10	WAAxx755	10
RAL 0805005	WAAxx111 GAAxx111	18	WAAxx011	21
RAL 0607005	WAAxx110 WAAxx210 GAAxx110	49	WAAxx010	49
RAL 0008500	WAAxx112 GAAxx112	70	WAAxx012	68
WHITE	WAAxx104 GAAxx023	79	WAAxx000 GAAxx052	90
RAL 0709010	WAAxx107 GAAxx107	78	WAAxx007	78
RAL 0508010	WAAxx108 GAAxx108	57	WAAxx008	63
RAL 0607020	WAAxx311 GAAxx311	39	WAAxx301	37
RAL 0607010	WAAxx312 GAAxx312	33	WAAxx302	32
RAL 0805010	WAAxx313 GAAxx313	18	WAAxx303	19
RAL 0502010	WAAxx681 GAAxx671	6	WAAxx671	7

Light reflectance values, unglazed floor tiles Taurus COLOR		Light reflectance values, unglazed floor tiles Taurus GRANIT	
TAAxx019	8	TAAxx069	11
TAAxx007	16	TAAxx065	18
TAAxx006	26	TAAxx076	31
TAAxx003	35	TAAxx078	36
TAAxx011	65	TAAxx060	66
TAAxx010	51	TAAxx062	51
TAAxx025	19	TAAxx061	40
		TAAxx068	28
		TAAxx074	33
		TAAxx082	17
		TAAxx080	27
		TAAxx075	31

RAKO HOME		
Serie	Light reflectance values, unglazed floor tiles	
Block	DAxxx780	37
Block	DAxxx781	27
Block	DAxxx782	18
Block	DAxxx783	11
Block	DAxxx784	39
Kaamos	DAxxx585	48
Kaamos	DAxxx586	43
Kaamos	DAxxx587	28
Kaamos	DAxxx588	14
Kaamos	DAxxx589	25
Piazzetta	DAxxx786	50
Piazzetta	DAxxx787	41
Piazzetta	DAxxx788	35
Piazzetta	DAxxx789	13

<p>RAL Design 0304060 rot red RAL Classic 3031 NCS 2070-Y90R Pantone 1807</p>		<p>WAA++373 WAA++363 GAA++459 GAA0K359</p>	<p>RAL Design 0502010 dunkelbraun dark brown RAL Classic 8019 NCS 8010-Y90R --</p>		<p>WAA++681 WAA++671 GAA1K671</p>
<p>RAL Design 0506080 orange orange RAL Classic 2004 NCS 0580-Y60R Pantone Orange 021</p>		<p>WAA++460 WAA++450 GAA1K460</p>	<p>RAL Design 0805010 grau-beige grey-beige RAL Classic 7006 NCS 5005-Y20R Pantone 450</p>		<p>WAA++313 WAA++303 GAA++313</p>
<p>RAL Design 0607050 hellorange light orange RAL Classic 1034 NCS 1050-Y40R Pantone 143</p>		<p>WAA++282 WAA++272 GAA++150</p>	<p>RAL Design 0607010 beige-grau beige-grey RAL Classic 1019 NCS 3010-Y20R --</p>		<p>WAA++312 WAA++302 GAA++312</p>
<p>RAL Design 0858070 dunkelgelb dark yellow RAL Classic 1018 NCS 1070-Y Pantone 107</p>		<p>WAA++222 WAA++201 GAA++142</p>	<p>RAL Design 0607020 dunkelbeige dark beige -- NCS 2010-Y40R Pantone 466</p>		<p>WAA++311 WAA++301 GAA1K311</p>
<p>RAL Design 0908040 gelb yellow -- NCS 1030-Y Pantone 460</p>		<p>WAA++221 WAA++200 GAA1K124</p>	<p>RAL Design 0508010 beige beige -- NCS 1005-Y50R Pantone 4755</p>		<p>WA+++108 WA+++008 GAA++108</p>
<p>RAL Design 0958070 gelb-grün yellow-green RAL Classic 1016 NCS 1070-G90Y Pantone 3965</p>		<p>WAA++464 WAA++454 GAA1K464</p>	<p>RAL Design 0709010 hellbeige light beige RAL Classic 9001 NCS 0603-Y30R --</p>		<p>WA+++107 WA+++007 GAA++107</p>
<p>RAL Design 1208050 hellgrün light green -- NCS 0550-G30Y Pantone 366</p>		<p>WAA++465 WAA++455 GAA1K465</p>	<p>WHITE weiß white RAL Classic 9003 NCS 0500-N --</p>		<p>WA+++104 WA+++000 GA+++023 GAA0K052</p>
<p>RAL Design 1306050 grün green RAL Classic 6018 NCS 2060-G30Y Pantone 369</p>		<p>WAA++466 WAA++456 GAA++466</p>	<p>RAL Design 0008500 hellgrau light grey RAL Classic 7047 NCS 2000-N Pantone 5315</p>		<p>WA+++112 WA+++012 GAA++112</p>
<p>RAL Design 1907025 türkis turquoise RAL Classic 6027 NCS 2030-B50G Pantone 564</p>		<p>WAA++467 WAA++457 GAA++467</p>	<p>RAL Design 0607005 grau grey RAL Classic 7044 NCS 4005-Y50R --</p>		<p>WA+++110 WA+++010 GAA++110</p>
<p>RAL Design 2408015 hellblau light blue -- NCS 1020-R90B Pantone 277</p>		<p>WAA++540 WAA++550 GAA++003</p>	<p>RAL Design 0805005 dunkelgrau dark grey RAL Classic 7039 NCS 5502-Y Pantone Warm grey 10</p>		<p>WAA++111 WAA++011 GAA1K111</p>
<p>RAL Design 2606025 blau blue RAL Classic 5024 NCS 2040-R80B Pantone 659</p>		<p>WAA++541 WAA++551 GAA1K127</p>	<p>RAL Design 0004000 anthrazit-grau anthracite grey RAL Classic 7043 NCS 7000-N Pantone 426</p>		<p>WAA++765 WAA++755 GAA++248</p>
<p>RAL Design 2902035 dunkelblau dark blue RAL Classic 5022 NCS 4550-R70B Pantone Blue 072</p>		<p>WAA++545 WAA++555 GAA+++5</p>	<p>RAL Design 0001500 schwarz black RAL Classic 7021 NCS 9000-N Pantone Black 3 2x</p>		<p>WAA++732 WAA++779 GAA++048 GAA0K548</p>

* Die hier abgebildeten Farbtöne und RAL Nummern haben nur Orientierungscharakter. | The colours codes and the shades shown are for orientation only. | Les codes de couleurs et les nuances illustrés sont uniquement à titre d'orientation.

DE RAKO OBJECT FARBSYSTEM

Das Sortiment der Marke RAKO OBJECT entspricht den Ansprüchen der modernen Architektur. Die Auswahl an 24 Farben und die Kombination der einzelnen Serien miteinander ermöglichen nahezu unbegrenzte Kreativität bei der Gestaltung Ihrer Entwürfe.

Mit der breiten Palette an Tages- und Nachtfarbtönen, sowie verschiedenen Oberflächen und Formaten bietet sich für Architekten und Planer eine nahezu unendliche Vielfalt technischer Lösungen und Farbgestaltungen.

Bei der Auswahl nach Farbsystemen wie NCS, RAL etc. ist zu beachten, dass die angegebenen Werte lediglich der groben Orientierung dienen und keine garantierten Farbwerte sind. Farbschwanken sind durch die natürlichen Inhaltsstoffe und das Produktionsverfahren nicht zu vermeiden und branchenüblich.

EN RAKO OBJECT COLOR SYSTEM

The RAKO OBJECT assortment meets the demands of the contemporary architecture. The range of 24 colours and the interconnectedness of the individual series support almost unlimited creativity in designs.

Featuring a varied palette of day and night shades, various surfaces and formats, unlimited technical and colour solutions are available to architects and designers.

FR RAKO OBJECT LE SYSTÈME COLOR

L'assortiment RAKO OBJECT répond aux exigences de l'architecture contemporaine. La gamme de 24 couleurs et l'interconnexion des séries individuelles soutiennent une créativité presque illimitée dans les conceptions.

Avec une palette variée de teintes diurnes et nocturnes, des surfaces et des formats variés, des solutions techniques et chromatiques illimitées sont à la disposition des architectes et designers.



Haftfestigkeit keramischer Belagselemente | Adhesion of ceramic tiles

DE Bei den keramischen Belagsmaterialien RAKO wird die Haftfestigkeit durch Klebstoffe nach der Norm EN 14 411 getestet. Durchgeführte Prüfungen bestätigen folgende Werte:

- $\geq 1,0 \text{ N/mm}^2$ für die Produktgruppe BIa mit der Wasseraufnahme $E \leq 0,5 \%$ und zementhaltige Mörtel des Typs C2
- $\geq 0,5 \text{ N/mm}^2$ für die Produktgruppe BIII mit der Wasseraufnahme $E > 10 \%$ und zementhaltige Mörtel des Typs C1
- $\geq 1,0 \text{ N/mm}^2$ für die Produktgruppe BIII mit der Wasseraufnahme $E > 10 \%$ und Dispersionsklebstoff
- $\geq 2,0 \text{ N/mm}^2$ für die Produktgruppe BIII mit der Wasseraufnahme $E > 10 \%$ und Reaktionsharzklebstoff

EN RAKO ceramic tiles are tested for adhesion towards cement-based adhesives pursuant to EN 14 411.

The performer analyses confirm the following values:

- $\geq 1.0 \text{ N/mm}^2$ for product group BIa with the water absorption $E \leq 0.5 \%$ and cementitious adhesives, type C2
- $\geq 0.5 \text{ N/mm}^2$ for product group BIII with the water absorption $E > 10 \%$, and cementitious adhesives, type C1
- $\geq 1.0 \text{ N/mm}^2$ for product group BIII with the water absorption $E > 10 \%$, and dispersion adhesives
- $\geq 2.0 \text{ N/mm}^2$ for product group BIII with the water absorption $E > 10 \%$, and reaction resin adhesives



Reaktion auf Feuer | Reaction to fire

DE Keramische Belagsmaterialien RAKO sind feuerbeständig. Sie sind nach der Norm EN 14 411 wie folgt zugeordnet:

- Klasse A1-A1_{FL} für die Produktgruppe BIa (Anlage G) mit der Wasseraufnahme $E \leq 0,5 \%$
- Klasse A1 für die Produktgruppe BIII (Anlage L) mit der Wasseraufnahme $E > 10 \%$

EN RAKO ceramic tiles are fire resistant. They are classified according to EN 14 411:

- Class A1-A1_{FL} for a BIa group of products (Annex G) with water absorption $E \leq 0.5 \%$
- Class A1 for a BIII group of products (Annex L) with water absorption $E > 10 \%$

**DE Pflege und Reinigung keramischer Wand- und Bodenfliesen**

Regelmäßige und richtige Reinigung ist ein entscheidender Bestandteil der Pflege von Fliesen. Das Verfahren und die Reinigungsmittel müssen entsprechend der Art der Verschmutzung, der Art der Oberfläche und der Reinigungsmethode richtig ausgewählt werden. Es gilt, dass in höherem Grad rutschhemmende Oberflächen immer besondere Sorgfalt bei der Pflege erfordern, einschließlich der Verwendung professioneller Reinigungsmittel. Die Reinigung mit Wasser allein funktioniert nicht, da Bodenbeläge ständig organischen und anorganischen Verunreinigungen ausgesetzt sind. Die Verwendung eines gewöhnlichen universellen Geschirrspülmittels für die Reinigung von Keramikfliesen ist ungeeignet. Diese Reinigungsmittel enthalten Spültenside, die den Boden entfetten. Wenn sie nicht ausreichend nachgespült werden, wirken sie wie ein Klettverschluss und ziehen noch mehr Schmutz an. Beachten Sie bei der Reinigung die empfohlene Verdünnung der Reinigungsmittel.

Bei der Reinigung keramischer Materialien ist es notwendig, Folgendes zu unterscheiden:

Bauendreinigung – Reinigung nach Abschluss der Bauarbeiten

Periodische Reinigung – normale regelmäßige Reinigung

Grundreinigung – Reinigung von tiefen, flächigen Verschmutzungen

Je nach Größe und Art der zu reinigende Fläche kann die manuelle Reinigung mit Lappen, Mopp, Bürste oder Pad (Reinigungsvlies) gewählt werden. Für große Flächen ist es ratsam, Scheuersaugmaschinen oder Hochdruckreiniger zu wählen. Hochdruckreiniger mit Sprühinjektor sind für stark verschmutzte und rutschhemmende Oberflächen geeignet. Unabhängig von der gewählten Reinigungsart muss darauf geachtet werden, dass loser Schmutz, der sich bei der Reinigung gelöst hat, entfernt wird und nicht wieder eintrocknet. Am schonendsten und zuverlässigsten lässt sich dieser mit einem leistungsstarken Wasserauger entfernen. Die Oberfläche sollte nach der Reinigung trocken bleiben.

Bauendreinigung – Reinigung nach Abschluss der Bauarbeiten

Nach Abschluss der Verlegearbeiten ist die Belagsfläche von bauseitig bedingten Verschmutzungen und von Resten von zementhaltigen Fugenmörteln zu reinigen. Dafür sind Reinigungsmittel mit Säuregehalt (pH < 6) geeignet, sog. Zementschleierentferner. Wir empfehlen die Verwendung von **RAKO SYSTEM CL802** mit pH 1,2–2,2. In dieser Reinigungsphase muss auf die empfohlene Konzentration des Reinigungsmittels geachtet werden, damit dunkle und stark pigmentierte Fugenmassen nicht angegriffen oder aufgehellt werden. Daher wird niemals konzentrierte Reinigungslösung auf die Fugen angewendet. Für Wandfliesen ist eine Verdünnung von 40–100 ml **RAKO SYSTEM CL802** pro 10 l Wasser zu verwenden. Für Bodenfliesen ist eine Verdünnung von 100–200 ml **RAKO SYSTEM CL802** pro 10 l Wasser zu verwenden. Die Fläche muss immer vorher gründlich gewässert werden, einschließlich der Fugen. Das Produkt nach dem Auftragen 10–15 Minuten einwirken lassen und mit Wasser neutralisieren. Wenn die Oberfläche nicht sauber ist, wird der gesamte Vorgang wiederholt. **RAKO SYSTEM CL802** nicht auf nicht säurebeständigen Materialien wie Marmor, Travertin etc. verwenden. Flecken organischen Ursprungs mit unverdünntem **RAKO SYSTEM CL810** (pH 8,5–9) mit Hilfe eines Pads lokal entfernen, 10–15 Minuten einwirken lassen, gelösten Schmutz entfernen und 2-mal mit Wasser neutralisieren.

Periodische Reinigung – normale regelmäßige Reinigung

Die normale regelmäßige Reinigung erfolgt durch Fegen, Staubsaugen und Wischen mit einem feuchten Tuch oder Mopp unter Verwendung eines geeigneten neutralen Reinigungsmittels (pH 7,0 bis 8,0). Wir empfehlen die Verwendung von **RAKO SYSTEM CL803** (Verdünnung von 20–60 ml je nach Verschmutzung pro 10 l Wasser) für alle Arten von Keramikfliesen in weniger belasteten Bereichen (Wohnungen, Einfamilienhäuser, Büros). In stark belasteten Bereichen (Geschäfte, Hallen, Flure, Mehrfamilienhäuser ...) kann **RAKO SYSTEM CL810** in Kombination mit **RAKO SYSTEM CL801** verwendet werden (siehe Grundreinigung).

Die periodische Reinigung umfasst die Einrichtung und die Innenausstattung mit Fliesen. Für die lokale Reinigung von Fliesen, Waschbecken, Badewannen, Duschkabinen, Armaturen oder der Außenseite von Toilettenschüsseln wird das saure Produkt **RAKO SYSTEM CL804** (pH 2) verwendet. Das Produkt entfernt mühelos Flecken und Kalkablagerungen und enthält einen Glanz, der die Verschmutzung der Oberfläche verlangsamt. Das Produkt direkt mit einer Sprühflasche auftragen und einige Minuten einwirken lassen, dann mit einem Schwamm abwischen und mit Wasser abspülen.

Grundreinigung – Beseitigung starker Verschmutzung

Zur Beseitigung starker Verschmutzung, die bei der normalen periodischen Reinigung nicht entfernt werden konnte, wird immer zuerst entfettet und zur Entfernung organischer Verschmutzungen wird der alkalische Reiniger **RAKO SYSTEM CL810** mit einem pH-Wert von 8,5–9 verwendet (Verdünnung 40–100 ml je nach Verschmutzung pro 10 l Wasser). Das Produkt auf die Oberfläche auftragen, 10–15 Minuten einwirken lassen und mit Wasser neutralisieren. Danach werden Kalk- und Mineralablagerungen (anorganischer Schmutz) mit dem sauren Reiniger **RAKO SYSTEM CL801** mit einem pH-Wert von 1,2–2,2 entfernt (Verdünnung je nach Verschmutzung 40–100 ml pro 10 l Wasser für Wandfliesen, 100–200 ml für Bodenfliesen). Das Produkt wieder 10–15 Minuten einwirken lassen und 2 x mit Wasser neutralisieren. Wenn die Oberfläche nicht sauber ist, den Vorgang wiederholen. Durch die Kombination von CL810 und CL801 können auch stark verschmutzte Fliesen gereinigt werden.

Zur Pflege von Wand- und Bodenfliesen dürfen auf keinen Fall Reinigungsmittel verwendet werden, die Fluorwasserstoffsäure enthalten, weil sie bereits nach kurzer Einwirkzeit keramische Fliesen massiv angreifen und dauerhaft beschädigen können!

Auf filmbildende und nicht empfohlene Reinigungsmittel ist zu verzichten. Diese können die rutschhemmende Wirkung keramischer Beläge stark beeinträchtigen, die Glasur schädigen oder zu optischen Beeinträchtigungen der Oberfläche, Streifenbildungen und Reinigungsproblemen führen. Grundsätzlich sind die Hinweise der Hersteller der Reinigungsmittel zur Anwendung und Dosierung genau zu beachten, weil bei Nichtbeachtung der Fliesenbelag, Fugen und elastische Dichtstoffe angegriffen bzw. beschädigt werden können.

Besondere Reinigungsverfahren:

- **Dekorative Elemente mit Gold-, Platin- und Perlmutteroberflächen** sind mit Wasser und neutralem Reinigungsmittel **RAKO SYSTEM CL803** zu reinigen (Verdünnung 20–60 ml je nach Verunreinigung pro 10 l Wasser). Es dürfen keine Reinigungsmittel mit abrasiven Substanzen oder aggressiven chemischen Stoffen eingesetzt werden.
- **Metallische Oberflächen** sind mit einer dünnen Metallschicht versehen und müssen sorgfältig gereinigt werden. Zur Beseitigung von Fugenmörtelresten und Schmutzflecken empfehlen wir, die Fugen zuerst vorzuwässern, dann die Fliesen mit verdünntem **RAKO SYSTEM CL810** Reiniger (Verdünnung 40–100 ml pro 10 l Wasser) entfetten, mit Wasser neutralisieren, die Verunreinigungen mit **RAKO SYSTEM CL801** (40–100 ml pro 10 l Wasser) entfernen und mit Wasser nachspülen. Die abwechselnde Anwendung der beiden Reinigungsmittel kann in Folge für eine perfekte Reinigung sorgen. Imprägnierungen oder ungeprüfte Reinigungsmittel werden für metallische Oberflächen nicht empfohlen.
- **Rutschhemmende Bodenbeläge sind regelmäßig mit den empfohlenen Produkten** entsprechend ihrer Verschmutzung zu reinigen. Jegliche Verunreinigung, Sand, Fette, Schnee- und Eisreste mindern deutlich den rutschhemmenden Charakter der Fliesenoberfläche. Vor und nach dem Einsatz saurer oder alkalischer Reinigungsmittel sind die Fliesen mit viel Wasser gründlich zu spülen. Für die Reinigung größerer Flächen sind Reinigungsmaschinen mit schonender mechanischer Reinigung oder mit Druckwasser geeignet. Wasser auf der Oberfläche von rutschhemmenden Fliesen, z. B. an Schwimmbeckenrändern oder auf Großküchenböden, kann mit speziellen Werkzeugen (z. B. Gummispachtel etc.) beseitigt werden.
- **Die Schimmelbildung in Fugen** wird durch regelmäßiges Lüften von Feuchträumen und die Verwendung des biozidhaltigen Fugenmörtels **RAKO SYSTEM GFBIO** reduziert.
- **Die Imprägnierung des Belags mit RAKO SYSTEM CL809** erleichtert seine Pflege und reduziert den Verbrauch von Reinigungsmitteln (geringere Konzentration). Die Imprägnierung verändert weder den Charakter der Keramik noch ihre Rutschfestigkeit. Vor der Imprägnierung ist eine perfekt saubere Oberfläche erforderlich. Eine dünne Schicht CL809 auf die Oberfläche der Keramikfliese auftragen und mit einem Mikrofasertuch verteilen, bis sie trocken ist. Die Imprägnierung hat keine dauerhafte Wirkung, sie nutzt sich bei Gebrauch ab und muss daher erneut aufgetragen werden. Für die normale, regelmäßige Pflege der so behandelten Fliesen ist eine Reinigung mit Wasser mit **RAKO SYSTEM CL803**, siehe oben, ausreichend.

**EN Maintaining and cleaning ceramic tiles**

Regular and proper cleaning is an integral part of tile care. The procedure and cleaning products must be correctly selected depending on how dirty they are, the surface type and the cleaning method. As a rule, more slip-resistant surfaces always require extra care during maintenance, including the use of professional cleaning products. Because floors are constantly exposed to organic and inorganic contaminants, cleaning with water alone is not enough. It is not appropriate to use an ordinary all-purpose dishwashing detergent to clean ceramic tiles. Such detergents contain rinsing agents (tensides), which will degrease the floor and attract more dirt if not properly rinsed off. When cleaning, follow the recommended dilution of cleaning agents.

When cleaning ceramic materials, the following distinctions must be made:

Post-construction cleaning – cleaning after completion of construction work

Periodic cleaning – routine periodic cleaning

Deep cleaning – thoroughly cleaning all surfaces

Depending on the size and type of surface to be cleaned, you can choose to clean manually with a rag, mop, brush or scouring pad. For large areas, it is advisable to utilise disc cleaning and vacuuming machines or high-pressure cleaning machines. High-pressure cleaners with spray injectors are suitable for heavily soiled and slip-resistant surfaces. Regardless of the type of cleaning method you select, care must be taken to ensure that any loose dirt that has been dissolved during cleaning is removed and does not dry onto the surface again. This is most gently and reliably removed using a powerful water vacuum cleaner. The surface should be dry after cleaning.

Post-construction cleaning – cleaning after completion of construction work

After the tiles have been laid, it is essential to clean the laid area, especially remove any residue left after the construction work and grouting. Acidic cleaners (pH < 6), also known as cement residue removers, are suitable for removing these contaminants. We recommend using **RAKO SYSTEM CL802** with a pH of 1.2–2.2. Care must be taken during this cleaning step to adhere to the recommended dilution of the cleaner, so that dark and highly pigmented grouts are not damaged or bleached. This means that you should never apply the concentrated cleaning solution to the grouted joints. For wall tiles, dilute 40–100 ml of **RAKO SYSTEM CL802** in 10 l of water. For floor tiles, dilute 100–200 ml of **RAKO SYSTEM CL802** in 10 l of water. The surface should always be thoroughly soaked with water beforehand, including the joints. After application, leave the product to dwell for 10–15 minutes and neutralise (rinse) with water. If the surface is still not clean, repeat the entire procedure. Do not use **RAKO SYSTEM CL802** on materials that are not acid-resistant, such as marble, travertine, etc. Remove local stains of organic origin using undiluted **RAKO SYSTEM CL810** (pH 8.5–9) and a scouring pad, leave to dwell for 10–15 minutes, remove any dissolved dirt, and neutralise twice with water.

Periodic cleaning – routine periodic cleaning

Normal routine maintenance is performed by sweeping, vacuuming and mopping with a damp cloth or mop using a suitable neutral cleaning product (pH 7.0 to 8.0). We recommend using **RAKO SYSTEM CL803** (20–60 ml diluted in 10 l of water depending on how soiled the surface is) on all types of ceramic floor tiles in low-traffic areas (flats, houses, offices). In high-traffic areas (shops, sheds, corridors, apartment buildings, etc.), **RAKO SYSTEM CL810** can be used in combination with **RAKO SYSTEM CL801** (see Deep cleaning).

Periodic cleaning includes furnishings and interior fittings with tiling. Use acidic **RAKO SYSTEM CL804** (pH 2) to clean specific areas, such as tiles, washbasins, baths, shower cubicles, taps or the outside of toilet bowls. This product easily removes stains and limescale deposits and leaves surfaces polished, which reduces surface soiling. Apply the product straight from the spray bottle and leave it to dwell for a few minutes, then wash off with a sponge and rinse with water.

Deep cleaning – removing heavy soiling

When cleaning heavily soiled surfaces, which could not be cleaned during normal periodic cleaning, always start by degreasing, then use the alkaline **RAKO SYSTEM CL810** cleaner with a pH of 8.5–9 (dilute 40–100 ml in 10 l of water, depending on how heavily soiled the surfaces are) to remove organic dirt. Apply the product to the surface, leave to dwell for 10–15 minutes and neutralise (rinse) with water. Continue cleaning by removing limescale and mineral deposits (inorganic contaminants) using **RAKO SYSTEM CL801** acidic cleaner with a pH of 1.2–2.2 (dilute 40–100 ml in 10 l of water for wall tiles, 100–200 ml for floor tiles, depending on how soiled they are). Once again, leave the product to dwell for 10–15 minutes and neutralise twice with water. If the surface is not clean, repeat the entire procedure. The combination of CL810 and CL801 cleaning product will clean even extremely dirty tiles.

Under no circumstances should cleaning products containing hydrofluoric acid be used to maintain tiles, as these cause massive and permanent damage to ceramic tiles after even short-term exposure! Do not use non-recommended cleaning products that form a film on the surface, which can reduce the slip resistance of ceramic tiles, damage the glaze, or visually alter the surface (streaking) and impair cleanability. It is important to follow the instructions of cleaning product manufacturers exactly with regard to product use and dosage, as failure to do so may damage the ceramic surface, joints and elastic sealants.

Special cleaning procedures:

- **Decorative elements embellished with gold, platinum and mother-of-pearl surfaces** should be washed with water and the neutral **RAKO SYSTEM CL803** cleaner (20–60 ml diluted in 10 l of water, depending on how soiled they are). Do not use products or tools containing abrasive particles or aggressive chemicals to clean them.
- **Metallic surfaces** have a metallic coating and require extra care when cleaning. To remove grout residues and dirt stains, we recommend first soaking the joints with water, degreasing the tiles with diluted **RAKO SYSTEM CL810** cleaner (dilute 40–100 ml in 10 l of water), neutralising with water and then removing any dirt with **RAKO SYSTEM CL801** (40–100 ml in 10 l of water) and rinsing with clean water. Use both cleaning products alternately for perfectly clean tiles. We do not recommend application of sealer or untested cleaners to metallic surfaces.
- **Slip-resistant floors should be cleaned regularly using the recommended products** depending on how soiled they are. Any dirt, sand, greasy surfaces or residual snow and ice significantly reduce the slip-resistant characteristics of the tile surface. Floors should be thoroughly rinsed with plenty of clean water before and after using acidic or alkaline cleaning agents. Gentle mechanical cleaning machines or pressure washers are suitable for cleaning larger areas. Special tools (rubber squeegees, etc.) are recommended for removing water from the surface of slip-resistant tiles, such as on swimming pool surrounds and large kitchen floors.
- **The formation of mould in joints** is reduced by regularly ventilating damp areas and by using **RAKO SYSTEM GFBIO** grout, which contains biocides.
- **Sealing (waterproofing) floor tiles with RAKO SYSTEM CL809** makes them easier to maintain and reduces the consumption of cleaning agents (lower concentration needed). The sealing process does not change the character of the ceramic or its slip resistance. The surface must be perfectly clean before sealing. Apply a thin layer of CL809 to the surface of the ceramic tile and wipe into the tile with a microfiber cloth until dry. The sealing coat is not permanent, it wears off over time as the floor is used, so it must be reapplied. For normal regular maintenance of tiles treated in this way, cleaning with water and **RAKO SYSTEM CL803** (see above) is sufficient.



Reinigungsverfahren

Bei Reinigung normaler keramischer Oberflächen ist folgendes Verfahren einzuhalten.

Reinigungsart	Verfahren	Reinigungsmittel und Dosierung
Bauabschlussreinigung – Entfernen von grobem Schmutz	Kehren oder Saugen	
Reinigung nach Abschluss der Bauarbeiten Entfernen von Zementresten, Mineral-, Kalk- und Magnesiumablagerungen, Zementschleiern, Dispersionsfarben und Rost	1. Belag und Fugen mit Wasser benetzen 2. Reinigungslösung aufbringen, 10 bis 15 Min. einwirken lassen und mit einem Wischmopp aus kurzen Mikrofasern, einem Mikrofaser-Pad, einer Silikonbürste oder einem Schwamm reinigen 3. Den aufgelösten Schmutz entfernen 4. Fliesen 2 x mit reichlich Wasser nachspülen	Saures Reinigungsmittel Dosierung nach Herstellerangabe
Beseitigung von Fett, Öl, Wachs, Kosmetik und Gummiabrieb von Schuhen	1. Reinigungslösung aufbringen, 10 bis 15 Min. einwirken lassen und mit einem Wischmopp aus kurzen Mikrofasern, einem Mikrofaser-Pad, einer Silikonbürste oder einem Schwamm reinigen 3. Den aufgelösten Schmutz entfernen 4. Fliesen 2 x mit reichlich Wasser nachspülen	Alkalisches Reinigungsmittel Dosierung nach Herstellerangabe
Periodische Reinigung – Beseitigung der üblichen Verschmutzung wie Staub, leicht anhaftender Schmutz, Schmutz von der Straße	Reinigungslösung aufbringen und mit einem Mikrofasermop oder -tuch wischen	Neutrales Reinigungsmittel Dosierung nach Herstellerangabe
Generalreinigung – saures Umfeld (Mineralverunreinigung: Zement-, Kalk-, Kalkseife-, Rost- Wasserstein-, Urinreste) Generalreinigung – alkalisches Umfeld (Fett- oder Ölverunreinigung)	1. Fliesenbelag und Fugen (!) mit Wasser benetzen 2. Reinigungslösung auftragen (auf Flecken kann eine konzentrierte Lösung verwendet werden) und mit einem Mikrofasermop, Mikrofaser-Pad oder Reinigungsmaschine reinigen 3. Den gelösten Schmutz entfernen 4. Fliesenbelag mit reichlich klarem Wasser nachspülen	Saures Reinigungsmittel Dosierung nach Herstellerangabe Alkalisches Reinigungsmittel Dosierung nach Herstellerangabe

Cleaning procedures

When cleaning standard ceramic surface please follow these procedures.

Type of cleaning	Process	Cleaning agents and dilution
Post-construction cleaning - cleaning of loose dirt	Sweeping or vacuuming	
Post-construction cleaning – cleaning of cement residues, mineral, calcium and magnesium deposits, cement bloom, paint rock, rust	1. Ceramic tiles and joints should be completely wet (use sufficient quantity of clean water) 2. Apply the cleaning solution, leave for 10 to 15 min. then clean with microfiber mop, pad or nylon brush or sponge 3. Remove dissolved dirt 4. Mop the tiles up twice with sufficient quantity of water	Acid detergent – dilution in accordance with the recommendations of the cleaning solution manufacturer
Removal of fats, oils, waxes, cosmetics and abrasions of from shoes	1. Apply the cleaning solution, let act leave for 10 to 15 min and clean with microfiber mop, pad or nylon brush or sponge 2. Remove dissolved dirt 3. Wash the tiles thoroughly with water afterwards	Alkaline detergent – dilution in accordance with the recommendations of the cleaning solution manufacturer
Regular cleaning - removal of normal soiling, such as dust, slightly sticky dirt, dirt from the street	Apply the cleaning solution, and clean with mop, pad, nylon brush or cloth	Neutral detergent - dilution in accordance with the recommendations of the cleaning solution manufacturer
General cleaning - acidic environment (mineral impurities: residues of cement, lime, calcium soaps, rust, scale, urines) General cleaning - alkaline environment (contaminated with grease or oil)	1. First, soak the tiles (joints)! 2. Apply the cleaning solution (concentrated solution may be used on stains) and clean using a mop with microfibers, a pad, or a cleaning machine 3. Remove the dissolved dirt by suction 4. Wash the tiles again thoroughly with water	Acid detergent – dilution in accordance with the recommendations of the cleaning solution manufacturer Alkaline detergent – dilution in accordance with the recommendations of the cleaning solution manufacturer

STO No. 030 - 059824
– Catalogue number: Xxxxxxxx
Formsteine (ceramic special pieces)

Technische Parameter Technical characteristics Caractéristiques techniques	Norm Norm Norme	Norm EN 14411 (max. Wert) Standard requirements EN14411 (max. value) Exigence de la norme EN14411 (max. valeur)	Werte LB (max.) Parameters LB (max.) Valeur LB (max.)
Abmessungen Sizes Dimensions	ISO 10545-2	Länge und Breite / Length and width Longueur et largeur	±2,0 %
		Dicke / Thickness / Epaisseur	±10 %
Wasseraufnahme / Water absorption Absorption d'eau	ISO 10545-3	E < 0,5 %	E < 0,5 %
Oberflächenbeschaffenheit Surface quality Qualité de la surface	ISO 10545-2	Min. 95 % der Fliesen ohne sichtbare Oberflächenmängel Min. 95 % of the tiles without visible defects Min. 95 % de pièces sans défauts visibles de la surface	Min. 95 % der Fliesen ohne sichtbare Oberflächenmängel Min. 95 % of the tiles without visible defects Min. 95 % de pièces sans défauts visibles de la surface
Biegefestigkeit Modulus of rupture Résistance à la flexion	ISO 10545-4	Dicke ≥ 7,5 mm min. 28 N/mm ² Thickness / Epaisseur	≥ 7,5 mm min. 28 N/mm ²
Bruchlast Breaking strength Force de rupture	ISO 10545-4	Dicke ≥ 7,5 mm min. 1300 N Thickness / Epaisseur	≥ 7,5 mm min. 1300 N
Temperaturwechselbeständigkeit Thermal shock resistance Résistance aux chocs thermique	ISO 10545-9	Wird nicht gefordert Not required N'est pas requis	Beständig Resistant Résistant
Frostbeständigkeit Frost resistance Résistance au gel	ISO 10545-12	Wird gefordert Required Requis	Vollständig Frostbeständig Fully frost resistant Résistance parfaite au gel
Widerstand gegen Glasrisse Crazing resistance for glazed tiles Résistance au tressailage	ISO 10545-11	Wird gefordert Required Requis	Beständig Resistant Résistant
Rutshemmende Eigenschaften Slipperiness - coefficient of friction Glissance - coefficient de frottement	EN 16165:2021 DIN 51130 DIN 51097 ČSN 725191	Wert und entsprechende Prüfungsmethode werden vom Hersteller bestimmt Manufacturer to state value and test method used Fabricant détermine valeur et processus d'essai adéquat	Ausgewählte Arten C Selected types C Pour les types choisis C
Widerstand gegen Tieferschleiß Deep abrasion resistance Résistance à l'abrasion profonde	ISO 10545-6	Wird nicht gefordert Not required N'est pas requis	Max. 275 mm ²
Oberflächenhärte laut Mohs Surface hardness according to Mohs scale Dureté de surface selon échelle de Mohs	ČSN EN 101	Klasse wird vom Hersteller bestimmt Manufacturer to state classification Classifié par fabricant	Min. Kl. 5 Min. cl. 5 Min. cl. 5
Wärmeausdehnungskoeffizient (20-100 °C) Coefficient of linear thermal expansion (20-100 °C) Coefficient de dilat. thermique linéaire (20-100°C)	ISO 10545-8	Wird nicht gefordert Not required N'est pas requis	Max. 9. 10 ⁻⁴ °C
Beständigkeit gegen im Haushalt verwendete chemische Stoffe Resistance to various chemicals used in household Résistance aux agents chimiques domestiques	ISO 10545-13	Min. B Min. B Min. B	Min. A Min. A Min. A
Beständigkeit gegen Säuren und Laugen in schwacher Konzentration Resistance to low concentrations of acids and alkalis Résistance. aux acides et bases de faible concentration	ISO 10545-13	Klasse wird vom Hersteller bestimmt Manufacturer to state classification Classifié par fabricant	Min. Kl. B Min. cl. B Min. cl. B
Beständigkeit gegen Säuren und Laugen in starker Konzentration Resistance to high concentrations of acids and alkalis Résistance aux acides et bases de haute concentration	ISO 10545-13	Wird nicht gefordert Not required N'est pas requis	Min. Kl. B Min. cl. B Min. cl. B
Fleckenbeständigkeit / Resistance to staining Résistance aux taches	ISO 10545-14	Min. Kl. 3 Min. cl. 3 Min. cl. 3	Min. Kl. 3 Min. cl. 3 Min. cl. 3
Abgabe gefährlicher Stoffe / Release of dangerous substances Relargage de substances dangereuses	ISO 10545-15	Wird nicht gefordert Not required N'est pas requis	Pb < 0,8 mg/dm ² Cd < 0,07 mg/dm ²

Weitere Informationen finden Sie in unserem Technischen Katalog | More information in our Technical Catalogue | Les informations détaillées sont indiquées dans le Catalogue Technique

Garantiebedingungen | Warranty terms and conditions | Conditions de garantie

DE Die LASSELSBERGER, s.r.o. Pilsen gewährleistet auf alle seine keramischen Belagelemente eine zweijährige Garantie auf alle durch die Norm EN 14411 festgelegte Eigenschaften. Mehr Informationen finden Sie unter www.rako.eu.

EN The manufacturer, LASSELSBERGER, s.r.o. Pilsen, provides for all company's ceramic tile products a 2-year warranty on properties defined by the applicable standard, EN 14411. More information at www.rako.eu.

FR Le fabricant LASSELSBERGER, s.r.o. Plzeň offre pour tous les éléments de revêtements céramiques une garantie de 2 ans pour les caractéristiques fixées par la norme respective EN 14411. Plus des informations sur la www.rako.eu.

		EN 14411, annex L BIII GL – Catalogue number: Wxxxxxx Wandfliesen (wall tiles)				EN 14411, annex H BIIb GL – Catalogue number: GARJDxxx Steinzeugfliesen (compact floor tiles)				EN 14411, annex G BIa GL, UGL – Catalogue number: Dxxxxxx, Gxxxxxx, Txxxxxx Feinsteinzeugfliesen (fully vitrified floor tiles)						
Technische Parameter Technical characteristics Caractéristiques techniques	Norm Norm Norme	Norm EN 14411 Anlage L BIII GL (max. Wert) Standard requirements EN 14411 annex L BIII GL (max. value) Exigence de la norme EN 14411 annexe L BIII GL (max. valeur)		Werte LB (max.) Parameters LB (max.) Valeur LB (max.)		Norm EN 14411, Anlage H BIIb GL (max. Wert) Standard requirements EN 14411 annex H BIIb GL (max. value) Exigence de la norme EN 14411 annexe H BIIb GL (max. valeur)		Werte LB (max.) Parameters LB (max.) Valeur LB (max.)		Norm EN 14411 Anlage G BIa GL, UGL (max. Wert) Standard requirements EN 14411 annex G BIa GL, UGL (max. value) Exigence de la norme EN 14411 annexe G BIa GL, UGL (max. valeur)		Werte LB (max.) Parameters LB (max.) Valeur LB (max.)				
		Standard Standard	Rektifiziert Rectified	Standard Standard	Rektifiziert Rectified	Standard Standard	Rektifiziert Rectified	Standard Standard	Rektifiziert - Länge von mindestens einer Seite < 60 cm Rectified - length of at least one side < 60 cm	Rektifiziert - Länge von mindestens einer Seite > 60 cm Rectified - length of at least one side > 60 cm						
Abmessungen Sizes Dimensions	ISO 10545-2	max		max		max		max		max		max				
		Länge und Breite / Length and width Longueur et largeur	±0,5 %	±2,0 mm	±0,3 %	±1,8 mm	±0,2 %	±1,2 mm	Länge und Breite / Length and width Longueur et largeur	±0,6 %	±2,0 mm	±0,4 %	±1,5 mm	±0,2 %	±1,5 mm	
		Dicke / Thickness / Epaisseur	±10 %	±0,5 mm	±5 %	±0,5 mm	±5 %	±0,5 mm	Dicke / Thickness / Epaisseur	±5 %	±0,5 mm	±0,5 %	±0,5 mm	±5 %	±0,5 mm	
		Geradheit / Linearity Linéarité des bords	±0,3 %	±1,5 mm	±0,2 %	±1,2 mm	±0,1 %	±0,9 mm	Geradheit / Linearity Linéarité des bords	±0,5 %	±1,5 mm	±0,25 %	±1,5 mm	±0,1 %	±0,6 mm	
Rechtwinkligkeit / Rectangularity Rectangularité	±0,5 %	±2,0 mm	±0,3 %	±1,3 mm	±0,2 %	±1,0 mm	Rechtwinkligkeit / Rectangularity Rectangularité	±0,5 %	±2,0 mm	±0,3 %	±1,8 mm	±0,25 %	±1,5 mm	±0,2 %	±1,5 mm	
Ebenflächigkeit der Leibungsflächen in der Flächenmitte/in der Kantenmitte/in den Ecken Surface flatness in the middle of the flat/edge/angles Planéité des surfaces au centre de la surface/au centre du bord/dans les angles	ISO 10545-2	+0,5 % -0,3 % ±0,5 %		+2,0 mm -1,5 mm ±2,0 mm	+0,3 % -0,15 % ±0,25 %	+1,0 mm -0,7 mm ±1,0 mm	+0,2 % -0,1 % ±0,25 %	+1,5 mm -0,7 mm ±1,5 mm	±0,5 %	±0,25 %	±0,5 %	±2,0 mm	±0,25 %	±1,2 mm	±0,25 %	±1,5 mm
Wasseraufnahme / Water absorption Absorption d'eau	ISO 10545-3	E > 10 %		E 10-20 %		0,5 % < E ≤ 3,0 % einzel 3,3 %, individuell 3,3 %		E < 2,5 %		UGL: E ≤ 0,5 % einzel max. 0,6 % GL: E ≤ 0,5 % einzel max. 0,6 % individuell max. 0,6 %		UGL: E ≤ 0,4 % einzel max. 0,6 % GL: E ≤ 0,5 % einzel max. 0,6 % individuell max. 0,6 %				
Oberflächenbeschaffenheit Surface quality Qualité de la surface	ISO 10545-2	Min. 95 % der Fliesen ohne sichtbare Oberflächenmängel Min. 95 % of the tiles without visible defects Min. 95 % de pièces sans défauts visibles de la surface		Min. 95 % der Fliesen ohne sichtbare Oberflächenmängel Min. 95 % of the tiles without visible defects Min. 95 % de pièces sans défauts visibles de la surface		Min. 95 % Stück ohne sichtbare Oberflächenmängel Min. 95 % of the tiles without visible defects Min. 95 % de pièces sans défauts visibles de la surface		Min. 95 % Stück ohne sichtbare Oberflächenmängel Min. 95 % of the tiles without visible defects Min. 95 % de pièces sans défauts visibles de la surface		Min. 95 % der Fliesen ohne sichtbare Oberflächenmängel Min. 95 % of the tiles without visible defects Min. 95 % de pièces sans défauts visibles de la surface		GL Min. 95 % der Fliesen ohne sichtbare Oberflächenmängel Min. 95 % of the tiles without visible defects Min. 95 % de pièces sans défauts visibles de la surface		UGL Min. 95 % der Fliesen ohne sichtbare Oberflächenmängel Min. 95 % of the tiles without visible defects Min. 95 % de pièces sans défauts visibles de la surface		
Biegefestigkeit Modulus of rupture Résistance à la flexion	ISO 10545-4	Dicke ≥ 7,5 mm min. 15 N/mm ² Dicke < 7,5 mm min. 12 N/mm ² Thickness / Epaisseur		≥ 7,5 mm min. 15 N/mm ² < 7,5 mm min. 12 N/mm ²		Min. 30 N/mm ² , Einzel min. 27 N/mm ² Min. 30 N/mm ² , Individual min. 27 N/mm ² Min. 30 N/mm ² , Individuellement 27 N/mm ²		Min. 35 N/mm ² , Einzel min. 32 N/mm ² Min. 35 N/mm ² , Individual min. 32 N/mm ² Min. 35 N/mm ² , Individuellement 32 N/mm ²		Min. 35 N/mm ² , Einzel min. 32 N/mm ² Min. 35 N/mm ² , Individual min. 32 N/mm ² Min. 35 N/mm ² , Individuellement 32 N/mm ²		Min. 35 N/mm ² , Einzel min. 32 N/mm ² Min. 35 N/mm ² , Individual min. 32 N/mm ² Min. 35 N/mm ² , Individuellement 32 N/mm ²		Min. 35 N/mm ² , Einzel min. 32 N/mm ² Min. 35 N/mm ² , Individual min. 32 N/mm ² Min. 35 N/mm ² , Individuellement 32 N/mm ²		
Bruchlast Breaking strength Force de rupture	ISO 10545-4	Dicke ≥ 7,5 mm min. 600 N, Dicke < 7,5 mm min. 200 N Thickness / Epaisseur		≥ 7,5 mm min. 600 N < 7,5 mm min. 200 N		Dicke ≥ 7,5 mm min. 1 100 N, Dicke < 7,5 mm min. 700 N Thickness / Epaisseur		Dicke ≥ 7,5 mm min. 1 300 N, Dicke < 7,5 mm min. 900 N Thickness / Epaisseur		Dicke ≥ 7,5 mm min. 1 300 N, Dicke < 7,5 mm min. 700 N Thickness / Epaisseur		Dicke ≥ 7,5 mm min. 1 300 N, Dicke < 7,5 mm min. 700 N Thickness / Epaisseur		Dicke ≥ 7,5 mm min. 1 300 N, Dicke < 7,5 mm min. 700 N Thickness / Epaisseur		
Temperaturwechselbeständigkeit Thermal shock resistance Résistance aux chocs thermique	ISO 10545-9	Wird nicht gefordert Not required N'est pas requis		Beständig Resistant Résistant		Wird nicht gefordert Not required N'est pas requis		Beständig Resistant Résistant		Wird nicht gefordert Not required N'est pas requis		Beständig Resistant Résistant		Beständig Resistant Résistant		
Frostbeständigkeit Frost resistance Résistance au gel	ISO 10545-12	Wird nicht gefordert Not required N'est pas requis		Nicht frostbeständig Not frost resistant Manque de résistance au gel		Wird gefordert Required Requis		Vollständig frostbeständig Fully frost resistant Résistance parfaite au gel		Wird gefordert Required Requis		Vollständig frostbeständig Fully frost resistant Résistance parfaite au gel		Vollständig frostbeständig Fully frost resistant Résistance parfaite au gel		
Widerstand gegen Glasrisse Crazing resistance for glazed tiles Résistance au tressillage	ISO 10545-11	Wird gefordert Required Requis		Beständig Resistant Résistant		Wird gefordert Required Requis		Beständig Resistant Résistant		Wird bei GL gefordert Required for GL Requis pour GL		Beständig Resistant Résistant		Beständig Resistant Résistant		
Rutschhemmende Eigenschaften Slipperiness - coefficient of friction Glissance - coefficient de frottement	EN 16165:2021 DIN 51130 DIN 51097 ČSN 725191	Wird nicht gefordert Not required N'est pas requis		Wird nicht gefordert Not required N'est pas requis		Wert und entsprechende Prüfungsmethode werden vom Hersteller bestimmt Manufacturer to state value and test method used Fabricant détermine valeur et processus d'essai adéquat		Wird nicht getestet Not tested Non testée		Wert und entsprechende Prüfungsmethode werden vom Hersteller bestimmt Manufacturer to state value and test method used Fabricant détermine valeur et processus d'essai adéquat		μ ≥ 0,3 Ausgewählte Arten Gruppen zugeteilt Selected types group Types choisis classés en groupes R9 - R13, A - C, μ ≥ 0,5		μ ≥ 0,3 Ausgewählte Arten Gruppen zugeteilt Selected types group Types choisis classés en groupes R9 - R13, A - C, μ ≥ 0,5		
Widerstand gegen Tieferschleif Deep abrasion resistance Résistance à l'abrasion profonde	ISO 10545-6	Wird nicht gefordert Not required N'est pas requis		Wird nicht gefordert Not required N'est pas requis		Wird nicht gefordert Not required N'est pas requis		Wird nicht gefordert Not required N'est pas requis		Glasiert - Glazed Wird nicht gefordert Not required N'est pas requis		Unglasiert - Unglazed Max. 175 mm ³ Max. 175 mm ³ Max. 175 mm ³		Wird nicht gefordert Not required N'est pas requis		
PEI Widerstand gegen Oberflächenverschleiß Deep abrasion resistance Résistance à l'abrasion de surface	ISO 10545-7	Wird nicht gefordert Not required N'est pas requis		Wird nicht gefordert Not required N'est pas requis		Klasse wird vom Hersteller bestimmt (Klasse PEI 1-5) Manufacturer to state classification (cl. PEI 1-5) Classifié par fabricant (classe PEI 1-5)		Wird nicht getestet Not tested Non testé		Klasse wird vom Hersteller bestimmt Manufacturer to state classification Classifié par fabricant		Wird nicht gefordert Not required N'est pas requis		Laut technischer Parameter im Katalog As shown in catalogue Comme mentionné dans le catalogue		
Oberflächenhärte laut Mohs Surface hardness according to Mohs scale Dureté de surface selon échelle de Mohs	ČSN EN 101	Klasse wird vom Hersteller bestimmt Manufacturer to state classification Classifié par fabricant		Min. Kl. 3 Min. cl. 3 Min. cl. 3		Klasse wird vom Hersteller bestimmt Manufacturer to state classification Classifié par fabricant		Min. Kl. 5 Min. cl. 5 Min. cl. 5		Klasse wird vom Hersteller bestimmt Manufacturer to state classification Classifié par fabricant		Min. Kl. 5 Min. cl. 5 Min. cl. 5		Min. Kl. 7 Min. cl. 7 Min. cl. 7		
Wärmeausdehnungskoeffizient (20-100 °C) Coefficient of linear thermal expansion (20-100 °C) Coefficient de dilat. thermique linéaire (20-100°C)	ISO 10545-8	Wird nicht gefordert Not required N'est pas requis		Max. 8 × 10 ⁻⁴ K ⁻¹ Max. 8 × 10 ⁻⁴ K ⁻¹ Max. 8 × 10 ⁻⁴ K ⁻¹		Wird nicht gefordert Not required N'est pas requis		Max. 8 × 10 ⁻⁴ K ⁻¹ Max. 8 × 10 ⁻⁴ K ⁻¹ Max. 8 × 10 ⁻⁴ K ⁻¹		Wird nicht gefordert Not required N'est pas requis		Max. 8 × 10 ⁻⁴ K ⁻¹ Max. 8 × 10 ⁻⁴ K ⁻¹ Max. 8 × 10 ⁻⁴ K ⁻¹		Max. 8 × 10 ⁻⁴ K ⁻¹ Max. 8 × 10 ⁻⁴ K ⁻¹ Max. 8 × 10 ⁻⁴ K ⁻¹		
Beständigkeit gegen im Haushalt verwendete chemische Stoffe Resistance to various chemicals used in household Résistance aux agents chimiques domestiques	ISO 10545-13	Min. B Min. B Min. B		Min. A Min. A Min. A		Min. B Min. B Min. B		Min. A Min. A Min. A		Min. B Min. B Min. B		Min. B Min. B Min. B		Min. A Min. A Min. A		
Beständigkeit gegen Säuren und Laugen in schwacher Konzentration Resistance to low concentrations of acids and alkalis Résistance aux acides et bases de faible concentration	ISO 10545-13	Klasse wird vom Hersteller bestimmt Manufacturer to state classification Classifié par fabricant		Min. Kl. B Min. cl. B Min. cl. B		Klasse wird vom Hersteller bestimmt Manufacturer to state classification Classifié par fabricant		Min. B Min. B Min. B		Klasse wird vom Hersteller bestimmt Manufacturer to state classification Classifié par fabricant		Min. B Min. B Min. B		Min. A Min. A Min. A		
Beständigkeit gegen Säuren und Laugen in starker Konzentration Resistance to high concentrations of acids and alkalis Résistance aux acides et bases de haute concentration	ISO 10545-13	Wird nicht gefordert Not required N'est pas requis		Min. Kl. B Min. cl. B Min. cl. B		Wird nicht gefordert Not required N'est pas requis		Min. B Min. B Min. B		Wird nicht gefordert Not required N'est pas requis		Min. B Min. B Min. B		Min. A Min. A Min. A		
Fleckenbeständigkeit / Resistance to staining Résistance aux taches	ISO 10545-14	Min. Kl. 3 Min. cl. 3 Min. cl. 3		Min. Kl. 3 Min. cl. 3 Min. cl. 3		Min. Kl. 3 Min. cl. 3 Min. cl. 3		Min. Kl. 3 Min. cl. 3 Min. cl. 3		Min. Kl. 3 für UGL Wird nicht gefordert für UGL Min. cl. 3 for GL Not required for UGL		Min. Kl. 3 Min. cl. 3 Min. cl. 3		NPD*		
Abgabe gefährlicher Stoffe / Release of dangerous substances Relargage de substances dangereuses	ISO 10545-15	Wird nicht gefordert Not required N'est pas requis		Pb < 0,8 mg/dm ² Cd < 0,07 mg/dm ²		Wird nicht gefordert Not required N'est pas requis		NPD*		Wird nicht gefordert Not required N'est pas requis		NPD*		NPD*		



DE ISO 14001 Ökologie und Entsorgung (Rückstände, Verpackungen und Abfälle)

Das Design der Verpackungen und die verwendeten Verpackungsmaterialien sind an ihren Zweck so weit wie möglich angepasst, damit die Produkte - die Keramikfliesen - vor Beschädigung während der Handhabung und des Transports geschützt werden, damit sie die wichtigsten Informationen über das Produkt enthalten und die anfallende Abfallmenge möglichst gering gehalten wird. Um die Umweltbelastung zu minimieren, ist ein ordnungsgemäßes Recycling von Verpackungsabfällen und Fliesenresten, die bei der Verlegung anfallen, von entscheidender Bedeutung. Es ist auch möglich, alte Fliesen am Ende des Produktlebenszyklus zu recyceln. Bei der Entsorgung sind die Piktogramme auf den Etiketten der Verpackung zu beachten. Unsere Produkte werden grundsätzlich in Pappkartons verpackt, mit Kunststoffolie umwickelt, mit Kunststoffband befestigt und auf einer Europalette aus Holz gelagert. Alle Verpackungsmaterialien sind vollständig recycelbar. Die Keramikfliesen und die bei der Verlegung anfallenden Verschnittstücke sind inert und ungiftig. Die keramischen Abfälle, die beim Verlegen oder Entfernen alter Keramikfliesen anfallen, können zum Verfüllen von Baugruben und nach dem Zerkleinern als Unterlage und Füllmaterial für andere Bauarbeiten verwendet werden. Bei der Entsorgung von Abfällen, die von keramischen Fliesen stammen, beachten Sie bitte das entsprechende Sicherheitsdatenblatt und die örtlichen Vorschriften für die Entsorgung von Bauabfällen.

Bestandteil der Firmenstrategie der LASSELSBERGER, s.r.o. ist die Herstellung umweltfreundlicher Produkte, welche die gültigen nationalen sowie internationalen Normen erfüllen und ein effizientes Umweltmanagementsystem nutzt.

Mit der Umweltproduktdeklaration (EPD) gemäß ISO 14 025 und EN 15 804 verpflichtete sich LASSELSBERGER, s.r.o., alle Anforderungen an den Umweltschutz einzuhalten.

Die RAKO Produkte wurden mit dem EU Ecolable ausgezeichnet.



Erklärung des Herstellers zu den vom LCA (Lebenszyklus des Produktes) abgeleiteten Umweltparametern:

Produktsystem und Grenze des Systems – siehe Tabelle Nr. 1

EN ISO 14001 Ecology and disposal (residues, packaging and waste)

The design of the packaging and packaging materials used are adapted to their purpose as much as possible to protect and secure the products - ceramic wall and floor tiles - from damage during handling and transport, provide the necessary information about the product, and minimise the volume of waste generated by the product packaging material. Proper recycling of both the packaging waste and ceramic tile offcuts generated during installation is essential for the minimisation of any environmental impact. It is also possible to recycle old wall and floor tiles at the end of the product's life cycle. The packaging material label pictograms should be followed for disposal. In principle, our products are packed in paper cartons coated with plastic film, fixed with plastic tape, and placed on a wooden EUR pallet. All the packaging materials are fully recyclable. Both the ceramic tiles and offcuts produced during installation are inert and non-toxic. Ceramic waste generated during installation or during the removal of old ceramic wall and floor tiles can be used for backfilling construction pits and, after crushing, as base and filling material in other construction works. In the case of disposal of waste arising from ceramic tiles, proceed in accordance with the relevant Safety Data Sheet and local regulations on construction waste disposal.

The strategy of LASSELSBERGER, s.r.o. is to produce environmentally friendly products that meet applicable national and international standards and utilize environmentally friendly control systems.

RAKO (brand of Lasselsberger group) products and services meet the criteria of EU Ecolabel



By releasing the environmental product declaration (EPD) as per ISO 14 025 and EN 15 804, LASSELSBERGER, s.r.o. has committed to adhering to the environmental requirements.

Declaration of the manufacturer regarding environmental parameters derived from the LCA (life-cycle assessment):

Products system and system boundaries – see Table 1.

Tabelle 1

Informationen über die Grenzen des Produktsystems – Informationsmodulen (X = umfasst, MNR = Modul nicht relevant)																
Information about the product system boundaries – information modules (X = included, MNR = module is not relevant)																
Produktionsphase Production phase			Bauphase Construction phase		Nutzungsphase Usage phase							Endphase des Lebenszyklus Life cycle phase				Ergänzende Informationen über den Rahmen des Lebenszyklus hinaus Additional information beyond the life cycle
A1	A2	A3	A4	A5	B1	B2	B3	B4	B5	B6	B7	C1	C2	C3	C4	D
Lieferung von Mineralrohstoffen Delivery of minerals	Transport Transport	Produktion Production	Transport zu die Baustelle Transport on site	Bauprozess/Installation Construction /installation proces	Nutzung Usage	Wartung Maintenance	Instandsetzung Repair	Austausch Replacement	Rekonstruktion Reconstruction	Betrieblicher Energieverbrauch Operational energy consumption	Betrieblicher Wasserverbrauch Operational water consumption	Abbrisse / Destruktion Demolition /deconstruction	Transport Transport	Abfallverarbeitung Waste treatment	Entsorgung Removal	Vorteile und Kosten hinter der Grenze des Systems. Potential of re-use, recovery and recycling.
X	X	X	X	X	MNR	X	MNR	MNR	MNR	MNR	MNR	MNR	X	X	X	X

Parameter, welche die Umwelteinflüsse beschreiben. | Parameters describing environmental impacts.
Die aktuellen Werte können unter www.rako.eu oder durch Scannen des QR-Codes heruntergeladen werden.
Scan QR code to view or download actual parametrs at www.rako.eu.

Sämtliche Informationen zur Ergänzung der Gebäudebewertung gemäß LEED und BREEAM stehen beim Qualitätsmanager des Unternehmens LASSELSBERGER, s.r.o. zur Verfügung.

All to the information supplementing the building assessment as per LEED and BREEAM are available from the quality manager of LASSELSBERGER, s.r.o.

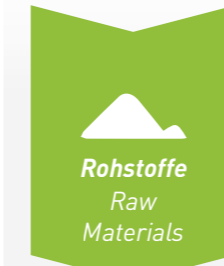

Rohstoffe
Raw
Materials

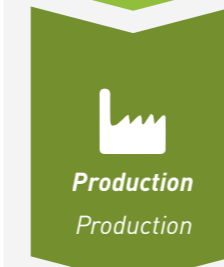

Production
Production



Anwendung
Applications



Verwendung und
Pflege
Use and
maintenance



Wiederver-
wendung
Reuse



Rohstoffe | Raw Materials

Wir verwenden mehr als 95 % unserer eigenen Rohstoffe aus lokalen natürlichen Ressourcen. Wir verwenden Ressourcen und Materialien wieder, recyceln oder erneuern sie.

We use more than 95% of our own raw materials from local natural resources. We reuse, recycle or renew resources and materials.

Production | Production

Effizientes Ressourcenmanagement ist für uns in der Produktion sehr wichtig. Wir reduzieren den Verbrauch von Strom, Erdgas und Wasser so weit wie möglich. Rohstoffe verwenden wir im größtmöglichen Umfang mit minimalem Abfall. Dank leistungsstarker Filter haben wir Emissionen reduziert.

Resource efficiency is the key to our production. We reduce our electricity, gas, and water consumption as much as possible. We use raw materials to the maximum with minimum waste. We have reduced our emissions with efficient filters.

Anwendung | Applications

Unsere Fliesen werden in vollständig recycelbaren Verpackungen aus Wellpappe geliefert. Auch Transportverpackungsmaterialien wie Kunststofffolien und -bänder sind recycelbar.

Our wall tiles are supplied in corrugated cardboard packaging that is fully recyclable. Shipping packaging materials such as plastic foil and tape are recyclable as well.

Verwendung und Pflege | Use and maintenance

Keramikfliesen geben keine Chemikalien oder Dämpfe an die Umwelt ab, sind ungiftig und stellen in keinem Innenraum ein Gesundheitsrisiko dar.

Ceramic tiles do not release any chemicals or vapours into the environment, are non-toxic and pose no health risk in any interior environment.

Wiederverwendung | Reuse

Wir recyceln keramische Abfälle, wir erfüllen das Konzept der Kreislaufwirtschaft. Rohstoffe ersetzen wir zum Teil durch gemahlene Fliesen. Ungebrannte Scherben und Staub aus den Filtern führen wir zur Aufbereitung zurück.

We recycle ceramic waste, fulfilling the circular policy concept. We use milled tiles to substitute some raw materials. We return unfired shards and dust from filters to processing.



DE Die rektifizierten Feinsteinzeug-Fliesen RAKO OUTDOOR 60 × 60 und 60 × 120 cm in der Stärke von 2 cm sind frostbeständig und deshalb halten sie der Belastung im Außenbereich ohne Einschränkung stand. Sie sind für Terrassen, Balkone, Flächen um Swimmingpools, für Pergolen oder nur als begehbare, in Rasenflächen eingelegte Gehwege geeignet. Dank ihrer Stärke und ihrem Gewicht können sie auch direkt auf Rasen, Splittbett oder auf Stelzlager ohne Verwendung von Klebstoffen verlegt werden. Ihre Qualität und ihre optische Erscheinung sind dank Digitaldrucks von Naturmaterialien nicht zu unterscheiden. Konkret bieten wir einzigartige Designs wie Stein, Holz, Zementspachtel in den Serien BETONICO, BRICOLA, CASTONE, CORE, KAAMOS, MIXTONE, PIAZZETTA, PINO, QUARZIT, RAVE, REBEL und VALS an.

EN Vitrified rectified RAKO OUTDOOR floor tiles 60 × 60 and 60 × 120 cm with a thickness of 2 cm are frost resistant, therefore they can withstand external loads without major limitations. These tiles are suitable for the construction and renovation of modern terraces, balconies, immediate surroundings of swimming pools, pergolas, roofs, or walking floor surfaces embedded in grass areas.

For their thickness and weight, the tiles can be laid in various fields, such as lawns, gravels, or placed on pedestals without the use of glue. Thanks to digital printing technology, the quality and design of these tiles are indistinguishable from natural materials, they faithfully imitate. Specifically, we can offer a unique design of stone, wood and cement in the BETONICO, BRICOLA, CASTONE, CORE, KAAMOS, MIXTONE, PIAZZETTA, PINO, QUARZIT, RAVE, REBEL and VALS series.

Verlegung im Garten | Laying into lawns

DE Dies Variante bietet eine dauerhafte Lösung für begehbare Flächen im Garten, Gartengehwege oder Pergolen. Verlegung auf Kies oder Schotter. Für die Bettung sollte Kies in der Körnung 4-8 mm mindestens in der Höhe 50 mm verwendet werden.

EN Durable solution of areas of gardens, garden paths, or pergolas intended as a final walking floor surface. When laying ceramic tiles into lawns, we use gravel (crushed aggregate), which, unlike sand, does not absorb water or expand during frost.

A gravel layer with a size of 4-8 mm should reach a height of 50 mm. RAKO OUTDOOR floor tiles with a thickness of 2 cm, but their movement is bordered with the surrounding soil and gravel, and seamlessly connects to lawns or pebbles in space.

Verlegung in Rasen für Gartenlaufflächen / Laying into lawn for garden treads

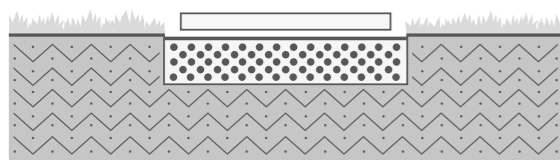

- 20 mm Bodenfliesen | Rasen
- 50 mm Kies 4-8 mm
- Boden

Verlegung auf Kies | Laying into gravel

DE Umweltfreundliche Lösung für begehbare Flächen bei Terrassen, Gehwegen, Pergolen oder Parkplätzen. Dank des wasserdurchlässigen Untergrundes wird Oberflächenwasser in den Untergrund abgeleitet. Die Schichten sollten auf allen Stellen dieselbe Stärke haben. Die Verlegung der Bodenfliesen selbst sollte 2 % Gefälle aufweisen, damit Wasser und Schmutz von der Oberfläche des Fliesenbelags abfließen kann.

EN Environmentally-friendly solution of areas intended as final walking floor surfaces of terraces, pavements, pergolas, or parking spaces. Thanks to the permeable base, water is returned into the subsoil and not removed from the landscape through drains and sewers. Before laying, remove the soil.

The bottom of the trench should have the required slope of 2% from the facility, and base layers should have the same thickness at all points of the surface. The laying of floor tiles should copy the required slope of 2% so that water and dirt are better drained from the surface.

Verlegung auf Kies für begehbare Flächen / Laying into gravel for walking surfaces

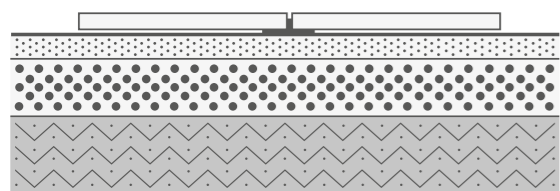

- 20 mm OUTDOOR Fliesen*
- 50 mm Kies 4-8 mm
- 200 mm verdichteter Kies 8-16 mm
- verdichteter Boden

* wird durch Fugenkreuze, speziell für die Verlegung in Kies, auf 3-4 mm begrenzt



Verlegung auf Kies für Parkplätze (bis 3,5 t) / Laying in gravel for parking spaces (up to 3.5 t)

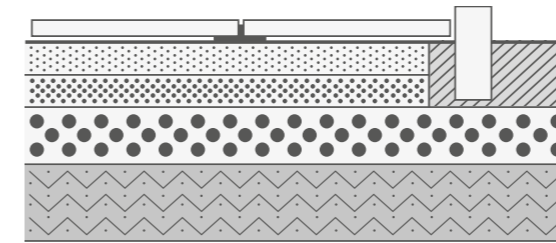

- 20 mm OUTDOOR Fliesen*
- 50 mm Kies 4-8 mm
- 50 mm verdichteter Kies 8-16 mm
- 200 mm verdichteter Kies 16-32 mm
- verdichteter Boden
- Bordstein (durchgängige Umrandung die in einem 100 mm hohen Betonbett angebracht wird)

*wird durch Fugenkreuze, speziell für die Verlegung in Kies, auf 3-4 mm begrenzt

- 20 mm, 30 mm floor tiles*
- 50 mm gravel 4-8 mm
- 50 mm compacted gravel 8-16 mm
- 200 mm compacted gravel 16-32 mm
- compacted soil
- curb (lines the laying and is installed in a 100 mm high concrete bed)

*defined by 3-4 mm wide for crosses for gravel

Verlegung auf Stelzlager | Laying on pedestals

DE Zur Verlegung auf Stelzlager ist ein tragfähiger fester Untergrund notwendig. Diese Art der Verlegung ist ausschließlich für den Fußgängerverkehr gedacht. Versiegelte Untergründe sollten ein Gefälle von 2 % haben und mit einer geeigneten Feuchtigkeitsisolation gegen Oberflächenwasser abgedichtet werden.

EN Laying on pedestals is a dry laying technique, based on the use of a system of supports, the so-called pedestals for terraces, balconies, roofs or public areas.

In case of pedestals, we can either choose adjustable (screwing) or fixed pedestals (layered onto each other). Thanks to adjustable pedestals, we can level-out e.g. slanting terraces into horizontal surfaces. We do not recommend horizontal laying for pedestals with fixed height. For tiling on pedestals, we use the RAKO OUTDOOR tiles with the thickness of 2 cm.

Laying on pedestals is not intended for being loaded with cars, it is only suitable for walking traffic.

Verlegung auf Stelzlager für begehbare Flächen mit einem Betonfundament / Laying on pedestals for walking

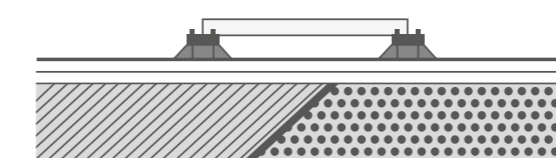

- 20 mm OUTDOOR Fliesen
- Stelzlager
- Hydroisolierung (PVC Folie, SBD Asphaltstreifen, endgültiger Abdichtungsestrich)
- Geotextilien
- Beton oder verdichteter Kies

- 20 mm tiles
- pedestals
- waterproofing (PVC foil, SBS asphalt strips, final waterproofing screed)
- geotextiles
- concrete or compacted gravel

Beispiel der Stelzlager Anwendung für Formate 60 × 60 und 60 × 120 / Assembly diagrams for pedestals

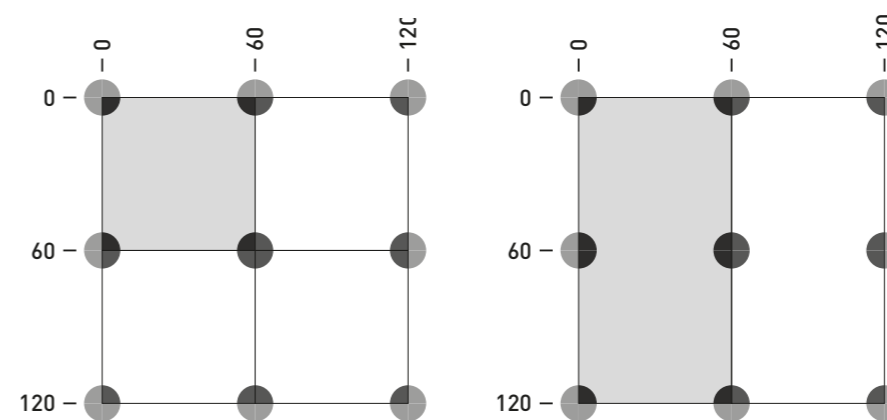

Empfehlung bei dem Einkauf und der Verlegung

DE Wie wählt man Keramikfliesen aus?

Was sind die Vorteile von Keramikfliesen?

- Keramikfliesen sind widerstandsfähig und haben keine Grenzen, weder im Innen – noch im Außenbereich
- Keramikfliesen haben eine höhere Abriebfestigkeit als Naturstein und
- bessere Wärmeleitfähigkeit und Wärmespeicherung als Laminat und Vinyl
- Sie sind hygienisch und sehr beständig gegen Chemikalien,
- haben höchste Widerstandsfähigkeit gegen Feuer und
- höhere UV-Beständigkeit
- Keramikfliesen schrumpfen im Laufe der Zeit nicht, was das Risiko von Leckagen im Untergrund verringert
- Sie wiegen nicht so viel wie Betonfliesen und die Konstruktion ist daher leichter
- Sie verschmutzen nicht die Umwelt und können recycelt werden

Wie wählt man Keramikfliesen aus?

Bei der Auswahl von Keramikfliesen sollten wir neben den ästhetischen Aspekten auch ihre funktionalen Eigenschaften berücksichtigen. Dies bedeutet, dass die Umgebung, in der die Produkte verlegt werden sollen, und die Art ihrer Verwendung berücksichtigt werden müssen. Wandfliesen sind nur für Innenwände geeignet. Die Fliesen sind widerstandsfähig und können daher sowohl in Innenräumen als auch im Außenbereich verwendet werden. Man kann sie auch problemlos an der Wand und auf dem Boden verwenden. Achten Sie bei der Auswahl der Produkte darauf, ob sie wirklich widerstandsfähig und für den Boden geeignet sind, und zwar anhand der vom Hersteller angegebenen Symbole.

Sind die Fliesen verschleißfest?

- Im Gegensatz zu anderen Materialien besteht bei Fliesen keine Gefahr, dass sie von Haustieren oder Kinderspielzeug zerkratzt oder beim Verschieben von Möbeln zerkratzt werden. Keramikfliesen bestehen aus einem sehr harten Material, das auf der Mohs-Härteskala den Wert 7 erreicht. Das ist etwa doppelt so hart wie bei einigen Natursteinen wie Travertin oder Marmor.
- Bei glasierten Fliesen kontrollieren wir den Wert der Abriebfestigkeit. Je höher die Abriebfestigkeit ist, desto größer ist die Belastung, der die Fliesen standhalten können. Für Wohnungen und Privathäuser ist ein Abriebwiderstandswert von PEI 3 ausreichend. Für anspruchsvolle Umgebungen, wie z. B. Büros oder Einkaufszentren, empfehlen wir Produkte mit der höchsten Abriebfestigkeitsklasse PEI 4 oder PEI 5. Die meisten glasierten RAKO-Fliesen weisen diese Werte auf.
- Für unglasierte Fliesen, die für die anspruchsvollsten Bereiche in Bezug auf die Abnutzung geeignet sind, ist der erforderliche Abriebwert wichtig. RAKO`s unglasierte Fliesen erfüllen diese Anforderung.

Warum ist die Rutschfestigkeit der Oberfläche wichtig?

- Die sichere Bewegung von Menschen, sowohl mit Schuhen als auch barfuß, wird maßgeblich von der Rutschfestigkeit der Oberfläche beeinflusst. Wenn Sie den richtigen rutschfesten Fliesenbelag wählen, sind die Fliesen auch bei Nässe nicht rutschig. Nasse Böden in Innenräumen und im Außenbereich auf Terrassen und rund um Schwimmbäder stellen die größte Herausforderung für die Gewährleistung der Rutschfestigkeit dar.
- Aufgrund von Praxis und nationalen Normen empfehlen wir für nasse Böden im Innenbereich eine rutschhemmende Oberfläche der Klasse R10 für das Gehen mit Schuhen und der Klasse B für das Barfußgehen. ABS-Oberflächen erfüllen nicht nur diese Anforderung an die Rutschfestigkeit, sondern sind auch sehr leicht zu reinigen. Für den Außenbereich empfehlen wir die Verwendung von Fliesen mit einer rutschhemmenden Oberfläche der Klasse R11/B. Es versteht sich von selbst, dass rutschhemmende Oberflächen besondere Sorgfalt bei der Pflege erfordern, einschließlich der Verwendung professioneller Reinigungsmittel.

Wie berechnet man die für ein Projekt benötigten Keramikfliesen richtig?

- Das manuelle Abzählen der benötigten Stücke oder Kartons von Keramikfliesen ist eine Herausforderung. Nicht jeder von uns hat ein gutes räumliches Vorstellungsvermögen. Zum Glück gibt es Visualisierungsprogramme für Keramikhändler, die Ihnen gerne einen Visualisierungsservice anbieten.
- Ausgehend von den vorgegebenen Maßen des Projekts simulieren die Visualisierungen dessen zukünftige Form. Sie enthalten u.a. Fliesenpläne (Musterzeichnung) und Stücklisten (Materialaufteilung). Daraus ergibt sich die endgültig benötigte Menge an Keramikfliesen.
- Die Produktkalkulationen sollten auf jeden Fall zusätzliches Material und eine um 15 %, bei großen Formaten sogar um 25 %, erhöhte Menge enthalten. Dies ist die zusätzliche Menge, die wir für Wandzuschnitte benötigen, insbesondere bei der Verlegung auf der Fase oder für unerwartete spätere Anpassungen.

Was ist vor der Verlegung zu beachten?

- Wir empfehlen, vor der Verlegung die Qualität der Produkte zu prüfen. Packen Sie die Kartons aus und untersuchen Sie stichprobenartig mehrere Stücke auf Oberflächen – und Maßfehler oder Risse.
- Nach der Norm dürfen bis zu 5 % der verkauften Keramikfliesen sichtbare Mängel aufweisen. Bei Mängeln in der Bestellung können diese Produkte für Ausbesserungen oder an nicht sichtbaren Stellen verwendet werden.
- Wenn man Zweifel an der Qualität der Produkte hat, sollte man auf jeden Fall die Garantie in Anspruch nehmen und sich an den Händler wenden, bei dem man die Ware gekauft hat. Wenn es sich um ein Ladengeschäft handelt, werden wir eine Reklamation aufzeichnen. Wir empfehlen, die Ware bei einem autorisierten RAKO-Geschäft zu kaufen, da dieses vertraglich verpflichtet ist, die Reklamation zu bearbeiten und der Hersteller direkten Einfluss darauf hat. Die Garantie erstreckt sich nicht auf gebrauchsbedingten Verschleiß und auf Mängel, die durch unsachgemäße Behandlung verursacht wurden.
- Die Charge gibt Auskunft über den Farbton und die Größe. Es sollten keine Chargen mit unterschiedlichen Farbtönen und Abmessungen auf einer Fläche kombiniert werden.
- Die Farbnuance wird durch einen zwei – oder dreistelligen Code angegeben. Die zweite Position des zweistelligen Codes (FA) bestimmt den Farbton (A-V, Mitte K). Beim dreistelligen Code (7P4) bestimmt die dritte Position (1-9, Mitte 5) den Farbton. Die Abmessungen des Produkts in Millimetern werden dann durch den einstelligen Code (z. B. 8) bestimmt. Ein Produkt mit den Maßen 30 x 60 cm hat z. B. die genauen Abmessungen 298 x 598 mm. Bei rektifizierten Produkten wird an den Rändern die gleiche Charge aufgedruckt wie auf den Kartons.
- Die Charge ist nicht nur für die Gestaltung des Pflasters mit der gleichen Fuge und die Beibehaltung des gleichen Farbtons des Pflasters wichtig, sondern auch für den eventuellen Kauf von Fehlmengen.
- Wir empfehlen, vor der Verlegung die einzelnen Fliesenelemente aus mehreren Kartons zu entnehmen und die entstehende Fläche nach den inspirierenden Fotodokumentationen aus den RAKO-Katalogen oder nach der Website www.rako.eu zusammenzustellen.
- Überlassen Sie die Verlegearbeiten einem etablierten Fachbetrieb. Wenn Sie selbst Fliesen verlegen wollen, halten Sie sich an eine Systemlösung, die bewährte Verfahren bietet, siehe www.rakosystem.cz.

Warum ist es sinnvoll, Verpackungen und Materialreste aufzubewahren?

Es ist auf jeden Fall ratsam, nicht nur Quittungen und Kartons von Produkten, sondern auch Fliesenreste aufzubewahren. Bei Nachkäufen von Produkten benötigen Sie die Chargenangaben auf der Verpackung. Lagern Sie die Produkte an einem trockenen Ort und schützen Sie sie vor Frost.

Auf Produkte, die miteinander kombiniert werden sollen, muss bei der Bestellung hingewiesen werden. Toleranzen innerhalb der einzelnen Nuancen sind bei kombinierter Verlegung (Wand/Boden, Verband) im Vorfeld zu berücksichtigen und Maßtoleranzen über das Fugenbild auszugleichen.

Shopping tips and consideration before laying

EN How to choose ceramic tiles?

What are the advantages of ceramic tiles?

- Ceramic tiles are hardy and have no limits either indoors or outdoors
- Ceramic tiles have a higher abrasion resistance compared to natural stone and
- better thermal conductors and heat accumulators than laminates and vinyl
- Ceramic tiles do not shrink over time, which reduces the risk of leakage into the substrate
- They are hygienic and highly resistant to chemicals,
- highest fire resistance and
- higher UV resistant
- They do not weigh as much as concrete tiles and, therefore, the construction is lighter
- They do not pollute the natural environment and can be recycled

How to select ceramic tiles?

When selecting ceramic tiles we should consider their functional characteristics in addition to their aesthetic aspect. This means taking into account the environment, in which the products will be placed and how they will be used. Wall tiles are only suitable for internal walls. Ceramic tiles are hardy and can therefore be used both indoors and outdoors. You can also use them on the wall and on the floor without any problems. When selecting products check whether they are hard enough and suitable for the floor according to the symbols indicated by the manufacturer.

Are the tiles wear-resistant?

- Unlike other materials tiles are not at risk of being scratched by pets or children's toys, nor are they scuffed when moving furniture. A ceramic tile is comprised of a very hard material that reaches 7 on the Mohs hardness scale. This is roughly the double of some natural stones, such as travertine or marble.
- For glazed tiles we monitor the abrasion resistance value. The higher the degree of abrasion resistance, the greater the operational load the tiles can withstand. For apartments and private housing, an abrasion resistance rating of PEI 3 is sufficient. For demanding environments, such as offices or shopping centres, we recommend products with the highest abrasion resistance rating of PEI 4 or PEI 5. Most RAKO glazed tiles feature these values.
- For unglazed tiles, which are suitable for the most demanding areas in terms of wear, the required abrasiveness value is important. RAKOs unglazed tiles fulfil this requirement.

Why is the slip resistance of the surface important?

- The slip resistance of the surface is related to the safe movement of people both in shoes and barefoot. If you choose the right slip resistance tile surface, the tiles will not even be slippery when wet. Wet indoor floors and outdoor areas on terraces and around swimming pools present the most difficult challenge in ensuring slip resistance.
- On the basis of practice and national standards, we recommend using a slip-resistant surface of class R10 for walking in shoes and class B for barefoot walking for wet floors in the interior. ABS surfaces not only meet this slip resistance requirement but are also very easy to clean. For exteriors we recommend using tiles with a slip-resistant surface of class R11/B. It's obvious that slip-resistant surfaces require extra care in maintenance, including the use of professional cleaning products.

How to correctly calculate the ceramic tiles needed for the project?

- Manually counting the required pieces or cartons of ceramic tiles is challenging. Not all of us have a good eye for spatial visualisation. Fortunately, there are visualisation programs available for ceramic material sellers who will be happy to offer you a visualisation service.
- Based on the given dimensions of the project, the visualisations simulate its future form. They include among other things, tiling plans (pattern drawing) and piece lists (material breakdown). This will provide you with the final required quantity of ceramic tiles.
- Product calculations should definitely include extra material and a 15% increase in quantity, even 25% for large formats. This is the extra quantity you will need for wall cuts, especially when laying on the bevel, or for unexpected later adjustments.

What is important to do before you start tiling?

- We recommend a quality check of the products before installation. Unpack the cartons and randomly inspect several pieces for surface and dimensional defects or cracks.
- According to the standard it is allowed to find up to 5% of products with visible defects in the quantity of ceramic tiles sold. If there are any defects in the order, these products can be used for cuts or areas that are not visible.
- In any case, if you have any doubts about the quality of the products, make use of the warranty and contact the retailer from whom you purchased them. If it is a brick-and-mortar shop, make a complaint record. We recommend that you purchase the goods from an authorised RAKO store, which is contractually obliged to resolve the complaint and the manufacturer has a direct influence on it. In case of purchase from the manufacturer via the e-shop, use the complaint form, which can be downloaded at www.rako.eu. The warranty does not cover wear and tear caused by use and defects caused by improper handling.
- Check the product batch on the carton, it should be the same on all cartons. The batch gives information about the colour shade and size. Never mix production batches with different shades or sizes on one tiled surface.
- The colour shade is indicated by a two- or three-digit code. The second position of the two-digit code (FA) determines the colour shade (A-V, centre K). For the three-digit code (7P4), the third position (1-9, centre 5) determines the colour shade. The dimensions of the product in millimetres are then determined by a one-digit code (e.g. 8). For example, a 30 x 60 cm product has an exact size of 298 x 598 mm. In the case of rectified/edged products, the same batch is printed on the edges as on the cartons.
- The batch is not only important for designing the paving with the same joint and keeping the same colour shade of the paving, but also if additional goods must be purchased later.
- Before laying the tiles, we recommend that you remove the individual tiling elements from several cartons and compose the resulting surface according to the inspirational photo documentation from the RAKO catalogues or according to the www.rako.eu website.
- Entrust tiling work to an established professional company. If you plan to be tiling yourself, stick to a system solution that offers proven practices, see www.rakosystem.cz.

Why is it a good idea to keep your packaging and leftover material?

We definitely not only recommend keeping goods receipts and cartons, but also leftover tiles. In the case of subsequent purchases of products you will need the batch information on the packaging. Store goods in a dry place and protect them from frost.

L A S S E L S B E R G E R , s . r . o .

A d e l o v a 2 5 4 9 / 1 , 3 2 0 0 0 , P l z e ň

C z e c h R e p u b l i c , T : + 4 2 0 8 0 0 3 0 3 3 3 3

E : i n f o @ r a k o . c z , w w w . r a k o . e u

since 1883

RAKO

Brand of lasselsberggroup

2025



R ▲ K ● . ▶ U